

**DESCRIPTION**

The NE546 is a monolithic integrated circuit that provides an RF amplifier, IF amplifier, mixer, oscillator, AGC detector, and voltage regulator in a single IC. The primary application is super heterodyne AM radio receiver particularly in automobile radios. The NE546 is available in a 14 lead dual inline package.

**FEATURES**

- Low noise
- Build in AGC circuit
- Separately accessible amplifiers
- Mixer-oscillator stage with internal feedback
- High selectivity
- High image rejection

**PIN CONFIGURATION**

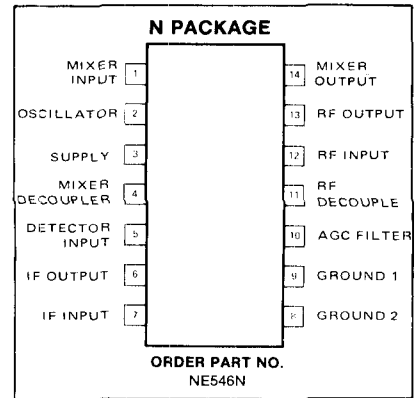

**BLOCK DIAGRAM**

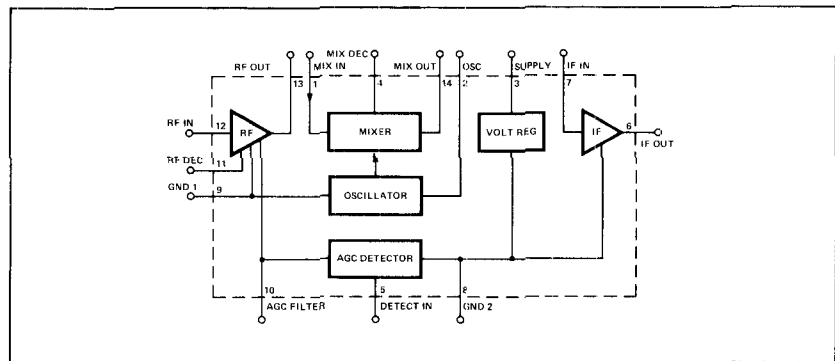

**ABSOLUTE MAXIMUM RATINGS**

PARAMETER	RATING	UNIT
V <sub>CC</sub>	Supply voltage pins 3, 13, 14 at pin 6	16 V
DC	Supply voltage (V+)	40 V
DC	Supply current	35 mA
	Internal power dissipation*	750 mW
	Lead temperature	300 °C
	Operating temperature range	-40 to +85 °C
	Storage temperature range	-65 to +150 °C

\*NOTE

Rating applies for temperatures up to 55°C.  
Derate linearly at 6.67mW/°C above 55°C.

EQUIVALENT SCHEMATIC

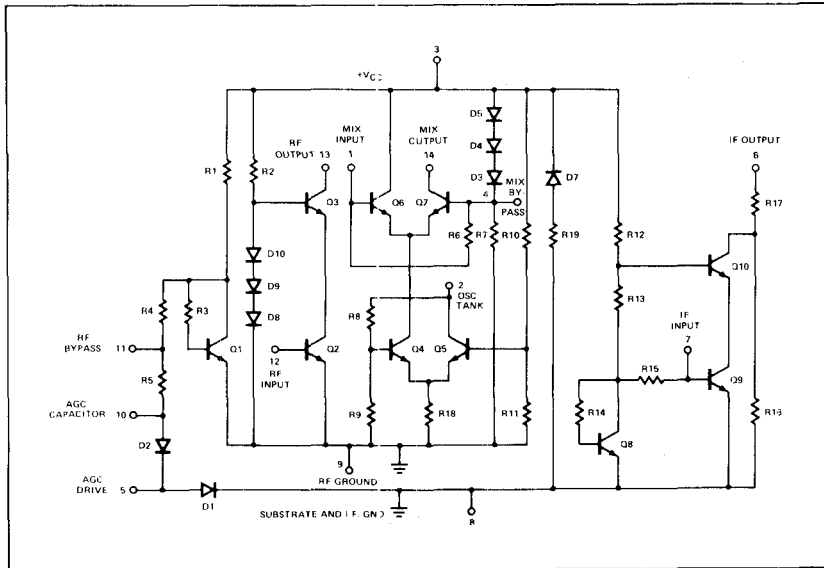

DC ELECTRICAL CHARACTERISTICS

PARAMETER	TEST CONDITIONS	NE546			UNIT	
		Min	Typ	Max		
DC VOLTAGE						
+VCC	Supply voltage	9.0		15.0	mV	
V <sub>OS</sub> (V <sub>1</sub> -V <sub>4</sub> )	Mixer balance		1.0			
V <sub>3</sub>	Zener voltage: at terminal 5	5.5	6.0	7.0	V	
V <sub>5</sub>	AGC voltage	0.1	0.25	0.4	V	
V <sub>7</sub>	Pin 7 voltage	0.55	0.70	0.80	V	
V <sub>12</sub>	Pin 12 voltage	0.6	0.71	0.8	V	
V <sub>13</sub>	Pin 13 voltage		4.0		V	
DC CURRENT						
I <sub>CC</sub>	Supply current	15	18	22	mA	
I <sub>2</sub>	Oscillator current		1.0		mA	
I <sub>3</sub>	Zener current	12	14	16	mA	
I <sub>6</sub>	IF current	3.5	4.3	6	mA	
I <sub>13</sub>	RF current		4.0	5	mA	
I <sub>14</sub>	Mixer current		0.17	0.38	mA	
STATIC						
V <sub>6</sub>	I.F. breakdown and linearity	Apply 5 volts to pin 6 only. V <sub>CC</sub> = 0 volts. Measure pin 6.	400	500	600	μA
V <sub>6</sub>	I.F. breakdown and linearity	Apply 25 volts to pin 6 only. V <sub>CC</sub> = 0 volts. Measure pin 6.*	2.0	2.5	3.0	mA

AC ELECTRICAL CHARACTERISTICS

PARAMETER	TEST CONDITIONS	NE546			UNIT
		Min	Typ	Max	
V <sub>sat</sub>	Saturation Per sensitivity test interrupting input signal measure output voltage.	500			mV
V <sub>sen</sub>	Sensitivity Input signal to dummy antenna at f <sub>IN</sub> = 1MHz, 30% AM modulation at f <sub>MOD</sub> = 400Hz, for 11mV output at V <sub>0</sub> .		2.5	5	μA
S/N	Signal-to-noise ratio Ratio of output at V <sub>0</sub> with modulation ON and then OFF, input signal = 100μV, 30% AM modulation at f <sub>MOD</sub> = 400Hz.	34			dB
Dist.	Overload distortion Input signal set at 1MHz, 90% AM modulation, distortion at V <sub>0</sub> must be 10%.	100	155	250	mV

NOTE

Performance characteristics in circuit of Figure 3.

TYPICAL PERFORMANCE CHARACTERISTICS

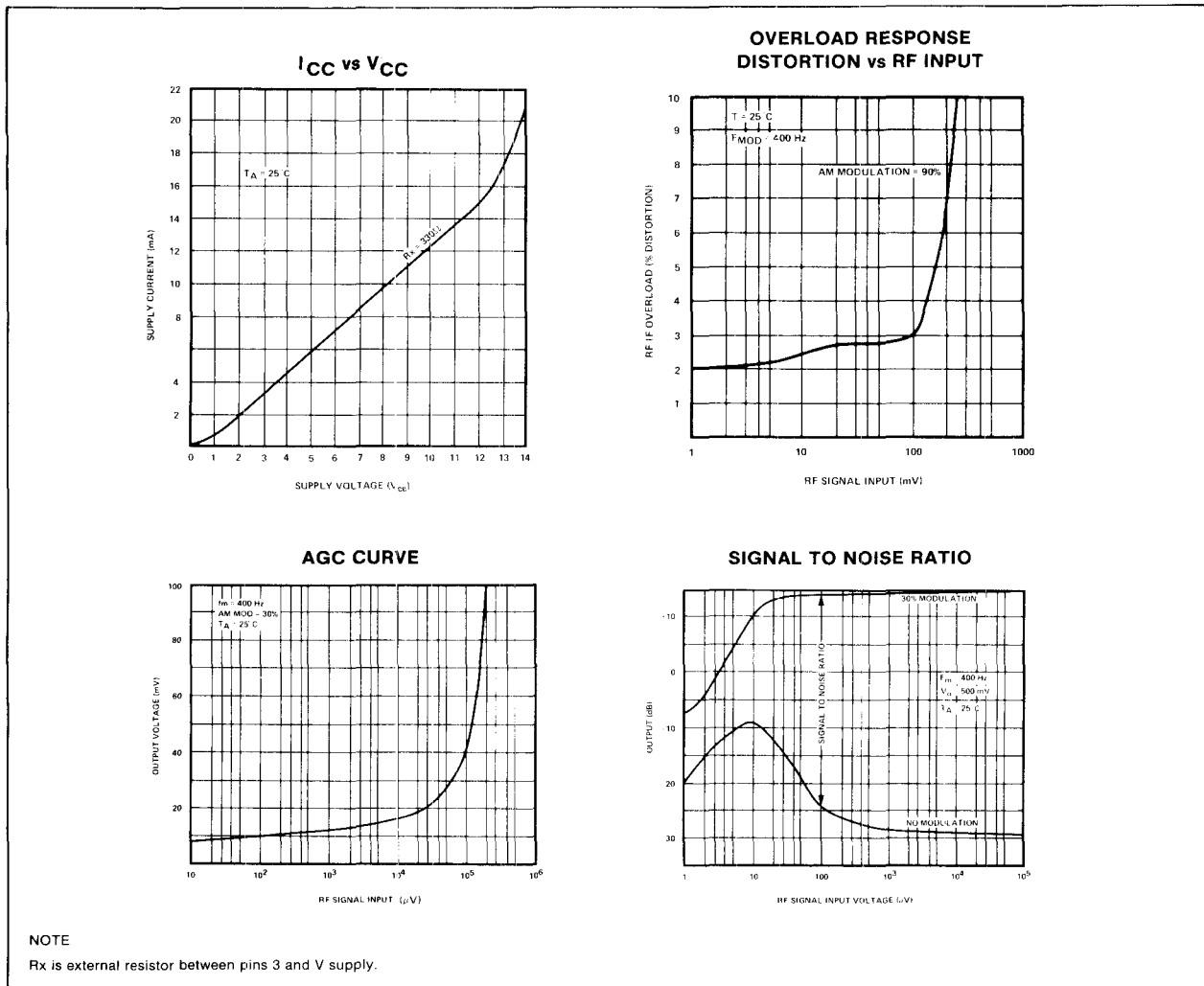

NOTE

R<sub>x</sub> is external resistor between pins 3 and V supply.



TYPICAL APPLICATIONS

AM RADIO (Capacitor Tuned)

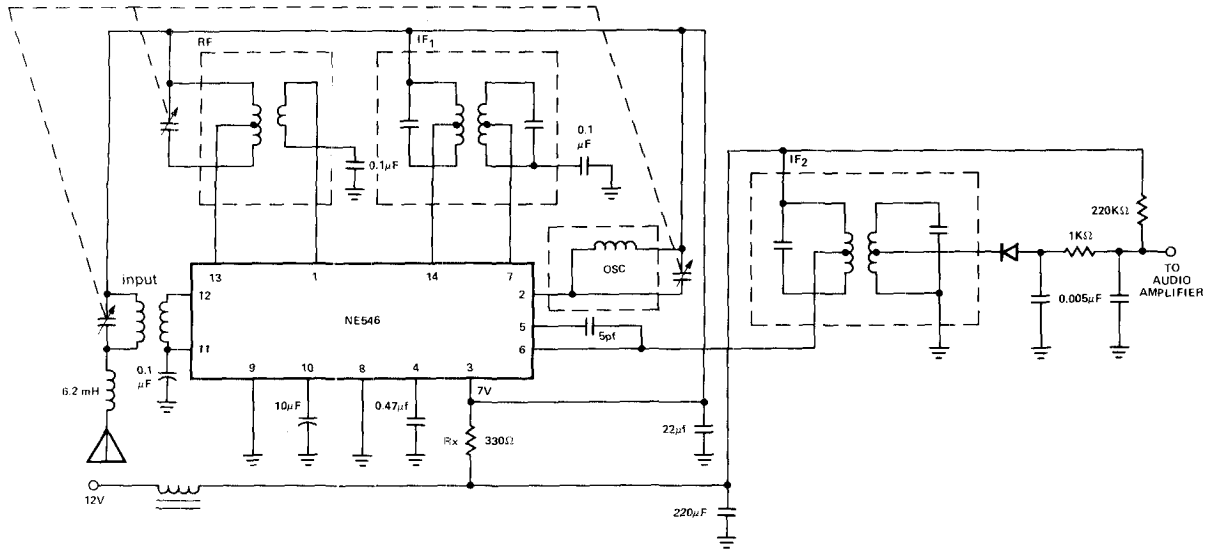

**VARIABLE CAPACITOR (Air Varicon)**  
 ANT & RF 13pF ~ 190pF  
 OSC 12pF ~ 80pF

**ANTENNA COIL**  
 10mm  $\phi$  < 120mm Ferrite Antenna

RF COIL

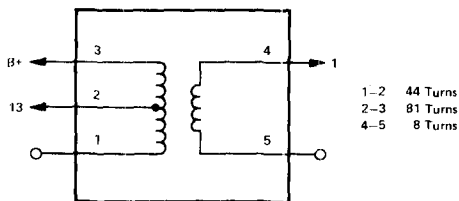

OSC COIL

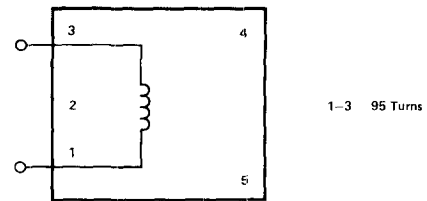

1st. IF COIL

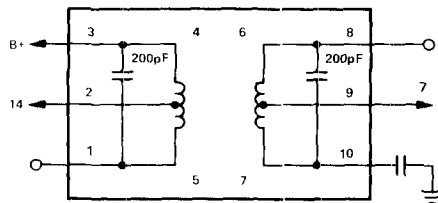

2nd. IF COIL

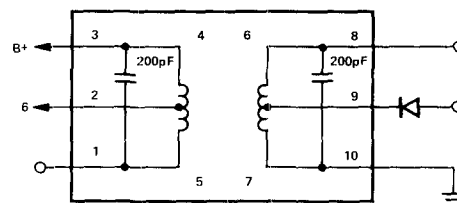

Figure 1