

*Parameters Subject to Change Without Notice*

## DESCRIPTION

The JW<sup>®</sup>5211 is a current mode monolithic buck switching regulator. Operating with an input range of 2.5V-6V, the JW5211 delivers 1.2A of continuous output current with integrated P-Channel and N-Channel MOSFETs. The internal synchronous power switches provide high efficiency. At light loads, the regulator operate in low frequency to maintain high efficiency and low output ripples. Current mode control provides tight load transient response and cycle-by-cycle current limit.

The JW5211 guarantees robustness with hiccup output short-circuit protection, FB short-circuit protection, start-up current run-away protection, input under voltage lockout protection, hot-plug in protection, and thermal protection.

The JW5211 provides output power good indication which is only available in SOT23-6 package.

The JW5211 is available in 5-pin TSOT23-5, SOT23-5 or 6-pin SOT23-6 package, which provides a compact solution with minimal external components.

*Company's Logo is Protected, "JW" and "JOULWATT" are Registered Trademarks of JoulWatt technology Inc.*

## FEATURES

- 2.5V to 6V operating input range
- Up to 1.2A output current
- Up to 94% peak efficiency
- High efficiency (>85%) at light load
- Internal Soft-Start
- 1.5MHz switching frequency
- Input under voltage lockout
- Short circuit protection
- Thermal protection
- Hot-plug in protection
- Output POK indication (available in SOT23-6 package)
- Available in TSOT23-5/SOT23-5/SOT23-6 package

## APPLICATIONS

- 5V or 3.3V Point of Load Conversion
- Set Top Boxes
- Telecom/Networking Systems
- Storage Equipment
- GPU/DDR Power Supply

## TYPICAL APPLICATION

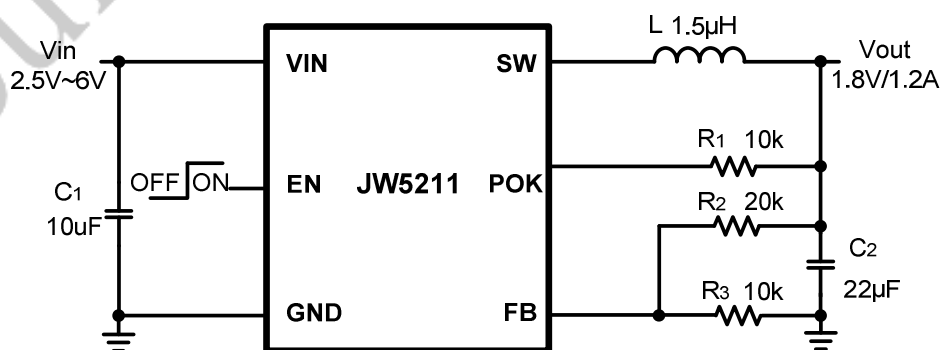

**ORDER INFORMATION**

DEVICE <sup>1)</sup>	PACKAGE	TOP MARKING <sup>2)</sup>
JW5211SOTA#TRPBF	SOT23-5	JWA5X YWLLL
JW5211SOTB#TRPBF	SOT23-6	JWA6X YWLLL
JW5211TSOTA#TRPBF	TSOT23-5	JWK4X YWLLL

**Notes:**

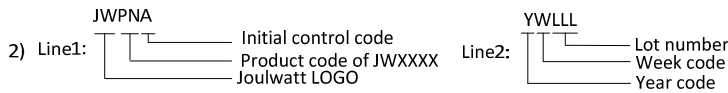
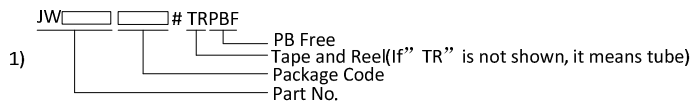

**PIN CONFIGURATION**

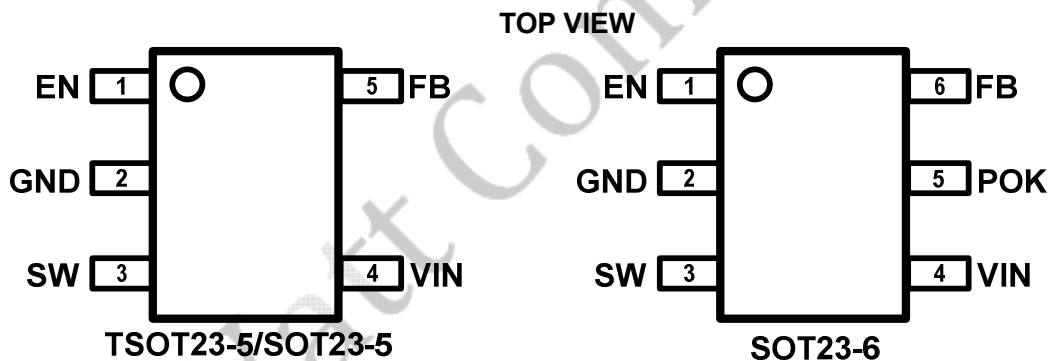

**ABSOLUTE MAXIMUM RATING<sup>1)</sup>**

EN, FB, POK Pins	-0.3V to 7.0 V
Vin, SW Pins	-0.3V(-1.7V for 20ns) to 7.0V(7.5V for 70ns)
Junction Temperature. <sup>2) 3)</sup>	150°C
Lead Temperature	260°C
ESD Susceptibility (Human Body Model)	2kV

**RECOMMENDED OPERATING CONDITIONS**

Input Voltage VIN	2.5V to 6V
Output Voltage Vout	0.6V to VIN
Operating Junction Temperature	-40°C to 125°C

**THERMAL PERFORMANCE<sup>4)</sup>**

**SOT23-5/SOT23-6**

Absolute Max Storage Temp.	Recommended Operating Junction Temp. Range	Recommended Max Case Temp. T <sub>c</sub> (°C)	Abs. Max Junction Temp. T <sub>j</sub> (°C)	Recommended Max Power Loss P <sub>D</sub> @25°C (W)
-65°C to 150°C	-40°C to 125°C	122	150	0.45
R <sub>θJC</sub> (°C/W)	R <sub>θJA</sub> (°C/W)	R <sub>θJB</sub> (°C/W)	ψ <sub>JT</sub> (°C/W)	ψ <sub>JB</sub> (°C/W)
130	220	36.1	2.3	35.3

**TSOT23-5**

Absolute Max Storage Temp.	Recommended Operating Junction Temp. Range	Recommended Max Case Temp. T <sub>c</sub> (°C)	Abs. Max Junction Temp. T <sub>j</sub> (°C)	Recommended Max Power Loss P <sub>D</sub> @25°C (W)
-65°C to 150°C	-40°C to 125°C	122	150	0.45
R <sub>θJC</sub> (°C/W)	R <sub>θJA</sub> (°C/W)	R <sub>θJB</sub> (°C/W)	ψ <sub>JT</sub> (°C/W)	ψ <sub>JB</sub> (°C/W)
110	200	36.1	2.3	35.3

**Note:**

- 1) Exceeding these ratings may damage the device.
- 2) The JW5211 guarantees robust performance from -40°C to 150°C junction temperature. The junction temperature range specification is assured by design, characterization and correlation with statistical process controls.
- 3) The JW5211 includes thermal protection that is intended to protect the device in overload conditions. Thermal protection is active when junction temperature exceeds the maximum operating junction temperature. Continuous operation over the specified absolute maximum operating junction temperature may damage the device.
- 4) Measured on JESD51-7, 4-layer PCB

## ELECTRICAL CHARACTERISTICS

<i>V<sub>IN</sub>=5V, T<sub>A</sub>=25 °C, unless otherwise stated.</i>						
Item	Symbol	Condition	Min.	Typ.	Max.	Units
V <sub>IN</sub> Under Voltage Lockout Threshold	V <sub>IN_UVLO</sub>	V <sub>IN</sub> rising	2.25	2.4	2.55	V
V <sub>IN</sub> Under Voltage Lockout Hysteresis <sup>5)</sup>	V <sub>IN_UVLO_HYST</sub>	V <sub>IN</sub> falling		180		mV
V <sub>IN</sub> Over Voltage Protection Threshold	V <sub>IN_OVP</sub>	V <sub>IN</sub> rising	6.5	7	7.5	V
V <sub>IN</sub> Over Voltage Protection Hysteresis <sup>5)</sup>	V <sub>IN_OVP_HYST</sub>	V <sub>IN</sub> falling		400		mV
Shutdown Current	I <sub>SHDN</sub>	V <sub>EN</sub> =0V		0.1	1	μA
Quiescent Current	I <sub>Q</sub>	V <sub>EN</sub> =2V, V <sub>FB</sub> =V <sub>REF</sub> *105%		40	60	μA
Regulated Feedback Voltage	V <sub>FB</sub>	2.5V<V <sub>IN</sub> <6V	0.582	0.6	0.618	V
PFET On Resistance <sup>5)</sup>	R <sub>DS(on)_P</sub>	V <sub>IN</sub> =3.6V, I <sub>SW</sub> =200mA		230		mΩ
NFET On Resistance <sup>5)</sup>	R <sub>DS(on)_N</sub>	V <sub>IN</sub> =3.6V, I <sub>SW</sub> =-200mA		150		mΩ
PFET Leakage Current	I <sub>LEAK_P</sub>	V <sub>IN</sub> =5.5V, V <sub>EN</sub> =0V, V <sub>SW</sub> =0V			1	uA
NFET Leakage Current	I <sub>LEAK_N</sub>	V <sub>IN</sub> =5.5V, V <sub>EN</sub> =0V, V <sub>SW</sub> =5.5V			1	uA
PFET Current Limit <sup>5)</sup>	I <sub>LIM_TOP</sub>	Duty Cycle=100%	1.4	1.6	1.85	A
Switch Frequency	F <sub>SW</sub>	I <sub>OUT</sub> =1.2A	1.2	1.5	1.8	MHz
Minimum On Time <sup>5)</sup>	T <sub>ON_MIN</sub>			80		ns
Maximum Duty Cycle <sup>5)</sup>	D <sub>MAX</sub>			100		%
EN Input Logic High Voltage	V <sub>EN_H</sub>	V <sub>EN</sub> rising, FB=0.4V	1.5			V
EN Input Logic Low Voltage	V <sub>EN_L</sub>	V <sub>EN</sub> falling, FB=0.4V			0.4	V
Thermal Shutdown Threshold <sup>5)</sup>	T <sub>SHDN</sub>			150		°C
Temperature Hysteresis <sup>5)</sup>	T <sub>HYS</sub>			15		°C

**Note:**

5) Guaranteed by design.

**PIN DESCRIPTION**

SOT23-5/ TSOT23-5 Pin	SOT23-6 Pin	Name	Description
1	1	EN	Drive EN pin high to turn on the regulator and low to turn off the regulator.
2	2	GND	Ground pin.
3	3	SW	SW is the switching node that supplies power to the output. Connect the output LC filter from SW to the output load.
4	4	VIN	Input voltage pin. VIN supplies power to the IC. Connect a 2.5V to 6V supply to VIN and bypass VIN to GND with a suitably large capacitor to eliminate noise on the input to the IC.
-	5	POK	Open drain output. Connect a 10KΩ resistor from POK to output. POK is high when $V_{FB}$ is within +/-12.5% of $V_{REF}$ .
5	6	FB	Output feedback pin. FB senses the output voltage and is regulated by the control loop to 0.6V. Connect a resistive divider at FB.

**BLOCK DIAGRAM**

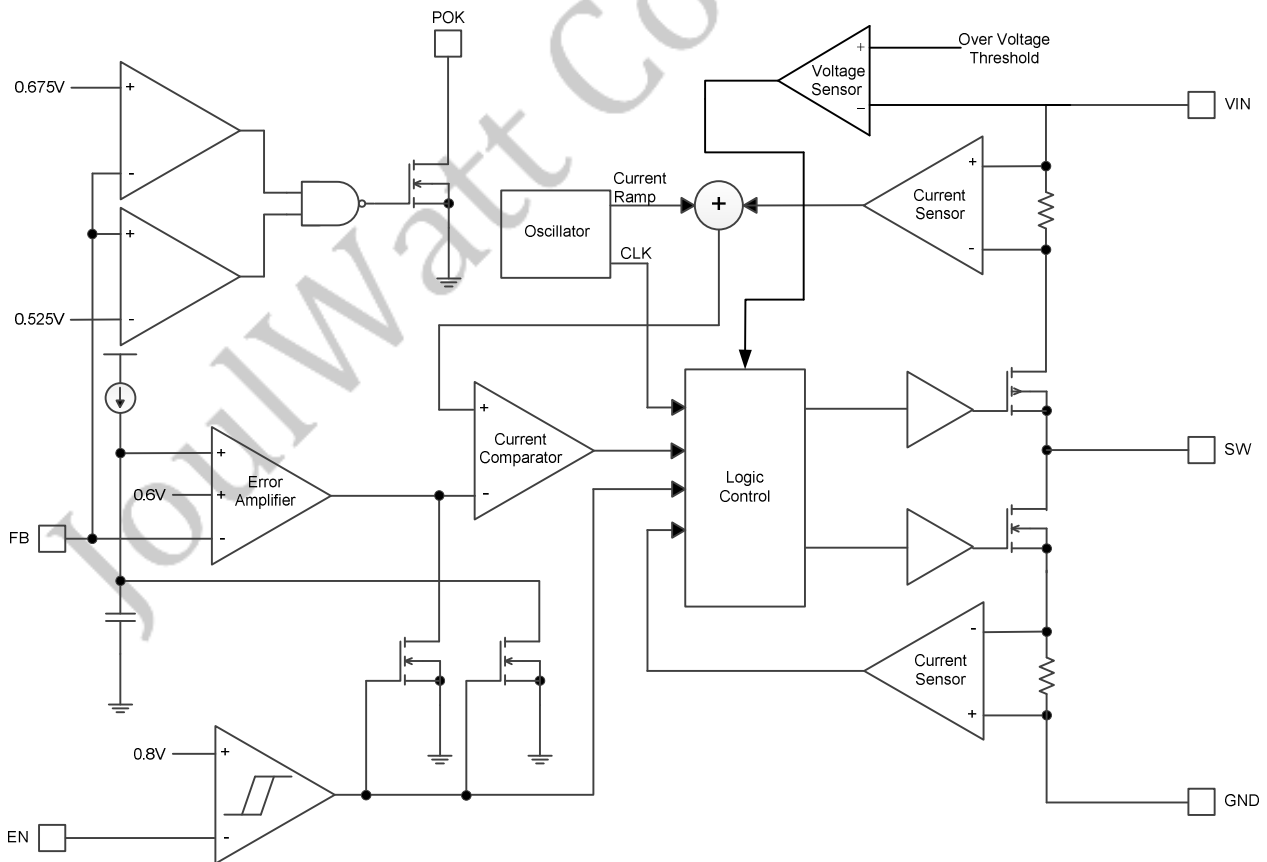

# TYPICAL PERFORMANCE CHARACTERISTICS

Vin = 5V, Vout = 1.8V, L = 1.5μH, Cout = 22μF, TA = +25°C, unless otherwise noted

### Steady State Test

VIN=5V, Vout=1.8V  
Iout=1.2A

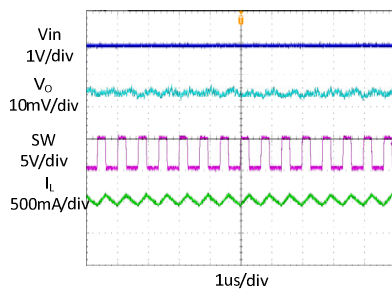

### Startup through Enable

VIN=5V, Vout=1.8V  
Iout=1.2A(Resistive load)

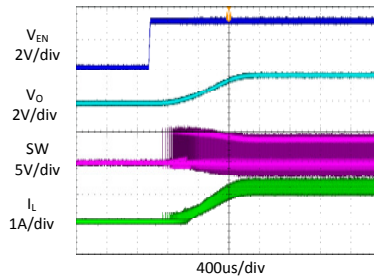

### Shutdown through Enable

VIN=5V, Vout=1.8V  
Iout=1.2A(Resistive load)

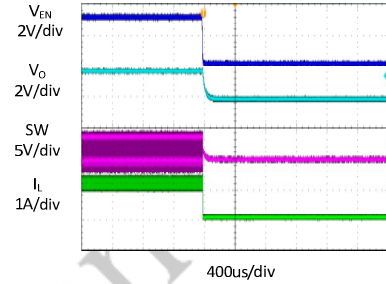

### Heavy Load Operation

1.2A LOAD

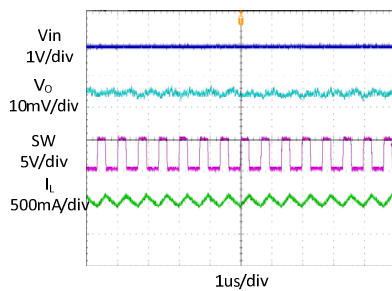

### Medium Load Operation

0.6A LOAD

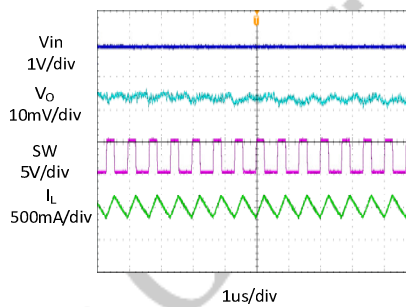

### Light Load Operation

0 A LOAD

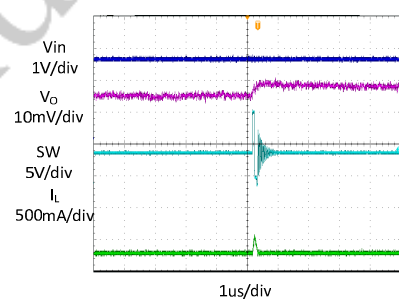

### Short Circuit Protection

VIN=5V, Vout=1.8V  
Iout=1.2A- Short

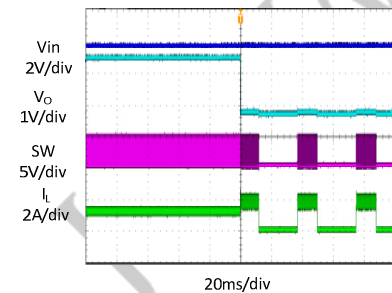

### Short Circuit Protection

VIN=5V, Vout=1.8V  
Iout= Short-1.2A

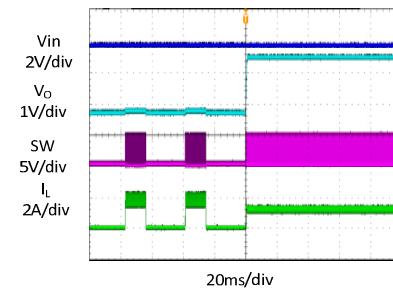

### Load Transient

0.6A LOAD → 1.2A LOAD → 0.6A LOAD

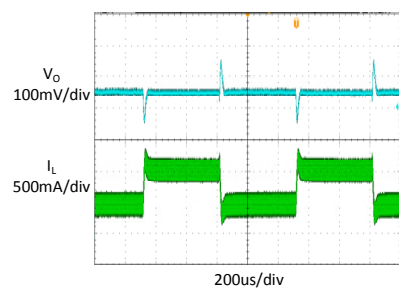

**TYPICAL PERFORMANCE CHARACTERISTICS (continued)**

Vin = 5V, Vout = 1.8V, L = 2.2μH, Cout = 22μF, TA = +25°C, unless otherwise noted

**Quiescent Current Vs. Input Voltage**

VIN=2.5V ~ 6.5V, VEN=2.5V, VFB=0.8V

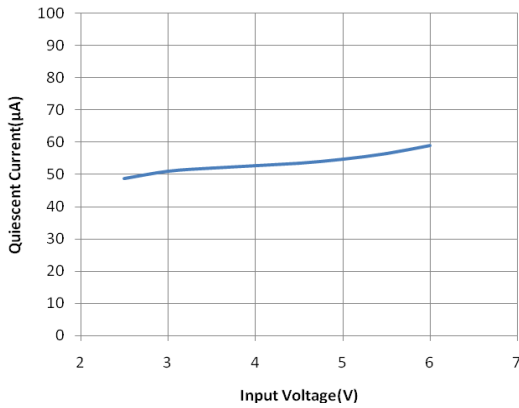

**Shutdown Current Vs. Input Voltage**

VIN=2.5V ~ 6.5V, VEN=0V, VFB=0.5V

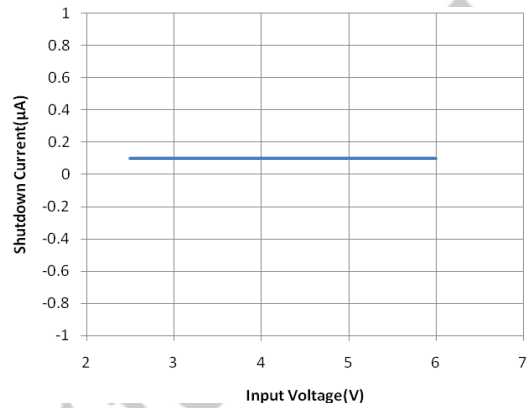

**Efficiency @ Vout=3.3V**

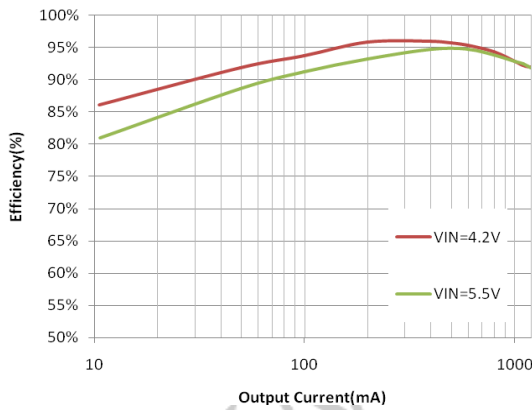

**Efficiency @ Vout=2.5V**

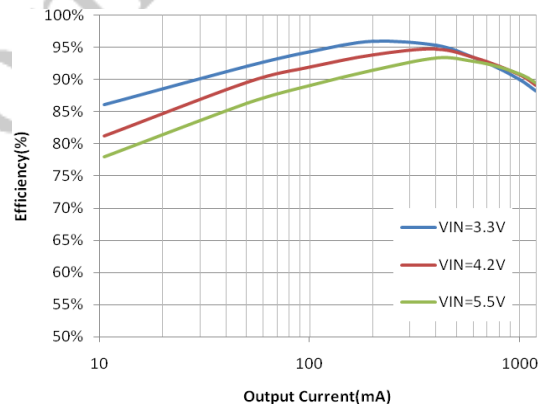

**Efficiency @ Vout=1.8V**

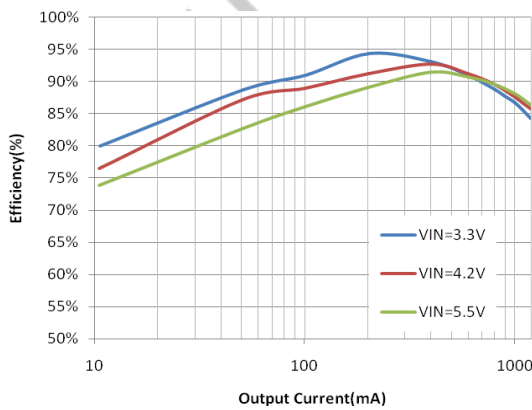

**Load regulation @ Vout=1.8V**

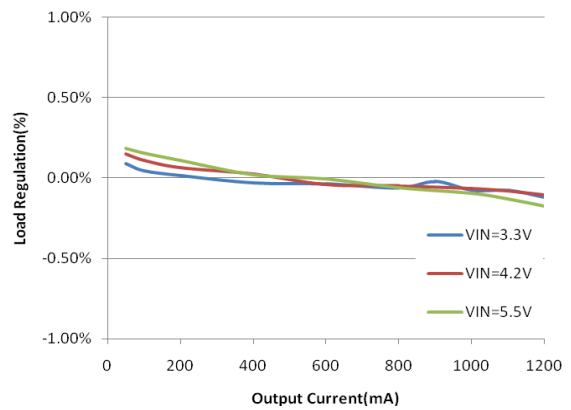

Reference Voltage Vs. Temperature

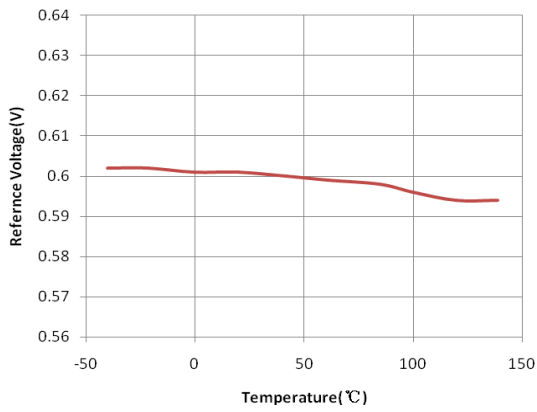

Frequency Vs. Temperature

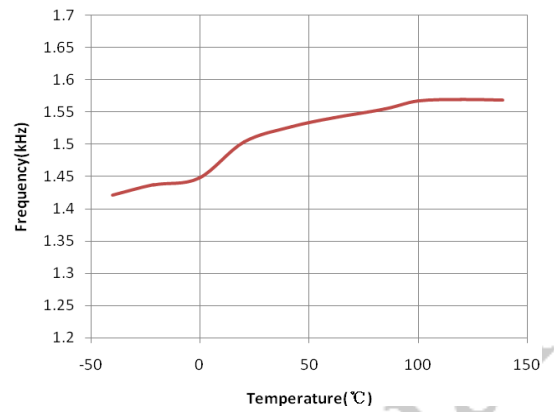

CurrentLimit Vs. Temperature

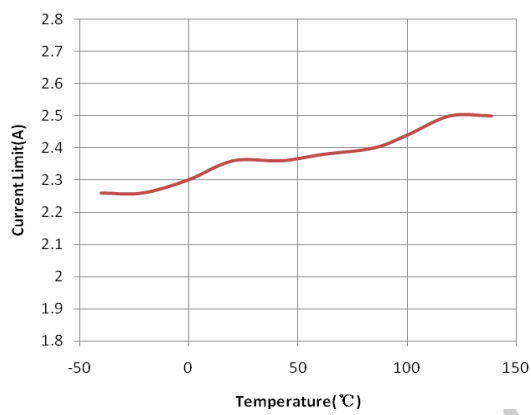

JoulWatt Confidential



## FUNCTIONAL DESCRIPTION

The JW5211 is a synchronous, current-mode, step-down regulator. It regulates input voltages from 2.5V~6V down to an output voltage as low as 0.6V, and is capable of supplying up to 1.2A of load current.

### Current-Mode Control

The JW5211 utilizes current-mode control to regulate the output voltage. The output voltage is measured at the FB pin through a resistive voltage divider and the error is amplified by the internal transconductance error amplifier.

Output of the internal error amplifier is compared with the switch current measured internally to control the output current limit.

### PFM Mode

The JW5211 operates in PFM mode at light load. In PFM mode, switch frequency is continuously controlled in proportion to the load current, i.e. switch frequency decreases when load current drops to boost power efficiency at light load by reducing switch-loss, while switch frequency increases when load current rises, minimizing output voltage ripples.

### Shut-Down Mode

The JW5211 operates in shut-down mode when voltage at EN pin is driven below 0.4V. In shut-down mode, the entire regulator is off and the supply current consumed by the JW5211 drops below 1 $\mu$ A.

### Power Switches

P-channel and N-channel MOSFET switches are integrated on the JW5211 to down convert the input voltage to the regulated output voltage.

### Hot-Plug In Protection

If the Vin voltage exceeds 6.85V, IC can turn off power switch, entering over-voltage protection.

It can remain in this state until Vin voltage is less than 6.5V.

### Output Current Run-Away Protection

At start-up, due to the high voltage at input and low voltage at output, current inertia of the output inductance can be easily built up, resulting in a large start-up output current. A valley current limit is designed in the JW5211 so that only when output current drops below the valley current limit can the bottom power switch be turned off. By such control mechanism, the output current at start-up is well controlled.

### Short Circuit Protection

When output is shorted to ground, the switching frequency is reduced to prevent the inductor current from increasing beyond PFET current limit. If short circuit condition holds for more than 1024 cycles, both PFET and NFET are forced off and can be enabled again after 8ms. This procedure is repeated as long as short circuit condition is not removed.

### FB Short Circuit Protection

When FB is shorted to ground and holds for more than 16 cycles, NFET could be turned off after inductor current drops to zero, and then both PFET and NFET are latched off. Only toggling EN or VIN UVLO/OVP can PFET and NFET be enabled again.

### Thermal Protection

When the temperature of the JW5211 rises above 150°C, it is forced into thermal shut-down.

Only when core temperature drops below 135°C can the regulator becomes active again.

## APPLICATION INFORMATION

### Output Voltage Set

The output voltage is determined by the resistor divider connected at the FB pin, and the voltage ratio is:

$$V_{FB} = V_{OUT} \cdot \frac{R_3}{R_2 + R_3}$$

where  $V_{FB}$  is the feedback voltage and  $V_{OUT}$  is the output voltage.

Choose  $R_3$  around 10K $\Omega$ , and then  $R_2$  can be calculated by:

$$R_2 = R_3 \cdot \left( \frac{V_{OUT}}{0.6V} - 1 \right)$$

The following table lists the recommended values.

V <sub>OUT</sub> (V)	R <sub>2</sub> (K $\Omega$ )	R <sub>3</sub> (K $\Omega$ )
1.2	10	10
1.5	15	10
1.8	20	10
3.3	49.9	11

### Input Capacitor

The input capacitor is used to supply the AC input current to the step-down converter and maintaining the DC input voltage. The ripple current through the input capacitor can be calculated by:

$$I_{C1} = I_{LOAD} \cdot \sqrt{\frac{V_{OUT}}{V_{IN}} \cdot \left( 1 - \frac{V_{OUT}}{V_{IN}} \right)}$$

where  $I_{LOAD}$  is the load current,  $V_{OUT}$  is the output voltage,  $V_{IN}$  is the input voltage.

Thus the input capacitor can be calculated by the following equation when the input ripple voltage is determined.

$$C_1 = \frac{I_{LOAD}}{f_s \cdot \Delta V_{IN}} \cdot \frac{V_{OUT}}{V_{IN}} \cdot \left( 1 - \frac{V_{OUT}}{V_{IN}} \right)$$

where  $C_1$  is the input capacitance value,  $f_s$  is the switching frequency,  $\Delta V_{IN}$  is the input ripple current.

The input capacitor can be electrolytic, tantalum or ceramic. To minimizing the potential noise, a small X5R or X7R ceramic capacitor, i.e. 0.1 $\mu$ F, should be placed as close to the IC as possible when using electrolytic capacitors.

A 2 $\mu$ F ceramic capacitor is recommended in typical application.

### Output Capacitor

The output capacitor is required to maintain the DC output voltage, and the capacitance value determines the output ripple voltage. The output voltage ripple can be calculated by:

$$\Delta V_{OUT} = \frac{V_{OUT}}{f_s \cdot L} \cdot \left( 1 - \frac{V_{OUT}}{V_{IN}} \right) \cdot \left( R_{ESR} + \frac{1}{8 \cdot f_s \cdot C_2} \right)$$

where  $C_2$  is the output capacitance value and  $R_{ESR}$  is the equivalent series resistance value of the output capacitor.

The output capacitor can be low ESR electrolytic, tantalum or ceramic, which lower ESR capacitors get lower output ripple voltage.

The output capacitors also affect the system stability and transient response, and a 22 $\mu$ F ceramic capacitor is recommended in typical application.

### Inductor

The inductor is used to supply constant current to the output load, and the value determines the ripple current which affect the efficiency and the output voltage ripple. The ripple current is typically allowed to be 30% of the maximum

switch current limit, thus the inductance value can be calculated by:

$$L = \frac{V_{OUT}}{f_s \cdot \Delta I_L} \cdot \left(1 - \frac{V_{OUT}}{V_{IN}}\right)$$

where  $V_{IN}$  is the input voltage,  $V_{OUT}$  is the output voltage,  $f_s$  is the switching frequency, and  $\Delta I_L$  is the peak-to-peak inductor ripple current.

**PCB Layout Note**

For minimum noise problem and best operating performance, the PCB is preferred to following the guidelines as reference.

1. Place the input decoupling capacitor as close to JW5211 (VIN pin and PGND) as possible to eliminate noise at the input pin. The loop area formed by input capacitor and GND must be minimized.
2. Put the feedback trace as far away from the inductor and noisy power traces as possible.

3. The ground plane on the PCB should be as large as possible for better heat dissipation.

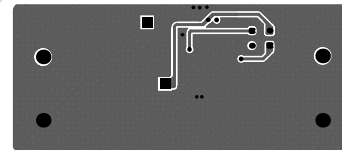
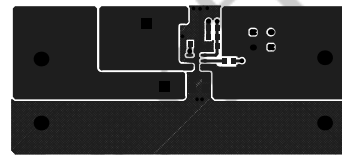
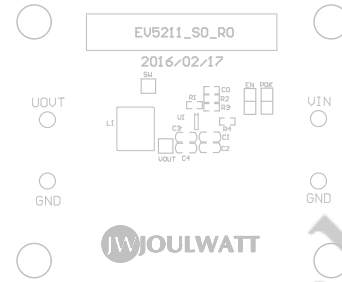

REFERENCE DESIGN

Reference 1:

$V_{IN}$ : 2.5V ~ 6V

$V_{OUT}$ : 1.8V

$I_{OUT}$ : 0~1.2A

Package: SOT23-6

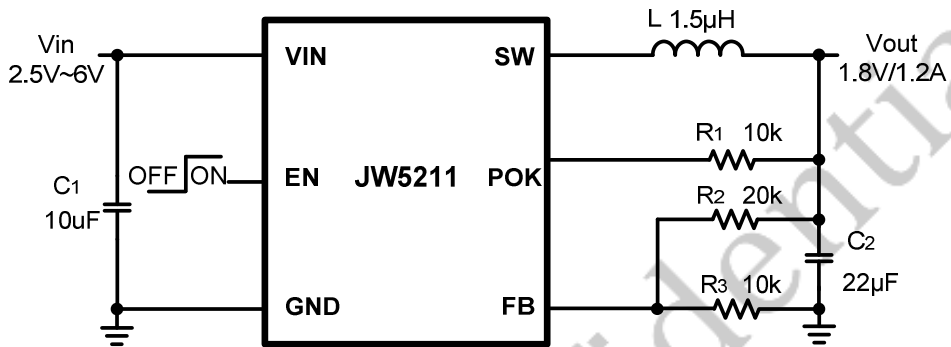

Package: SOT23-5/TSOT23-5

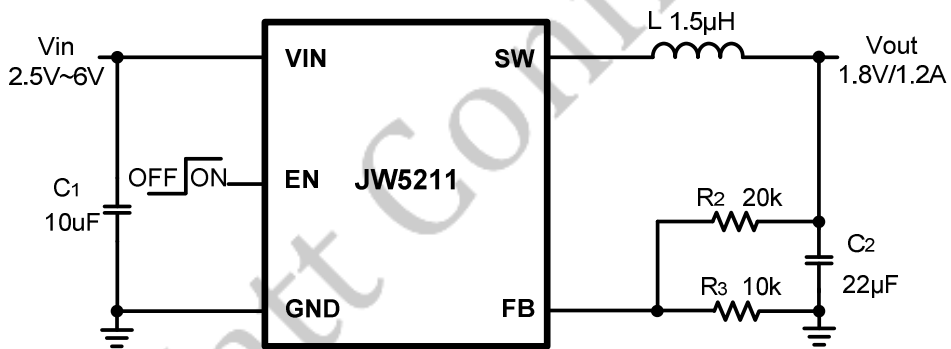

Reference 2:

$V_{IN}$ : 3.7V ~ 6V

$V_{OUT}$ : 3.3V

$I_{OUT}$ : 0~1.2A

Package: SOT23-6

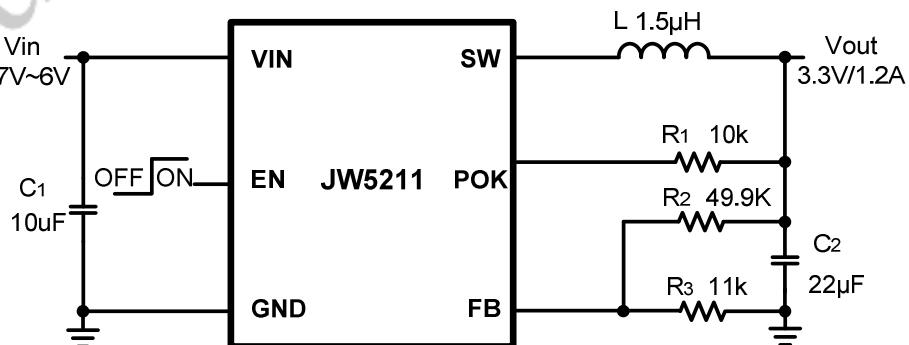

Package: SOT23-5/TSOT23-5

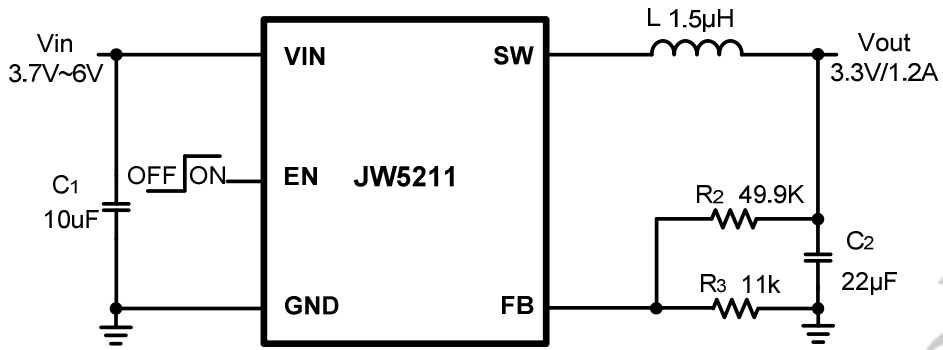

JoulWatt Confidential

PACKAGE OUTLINE

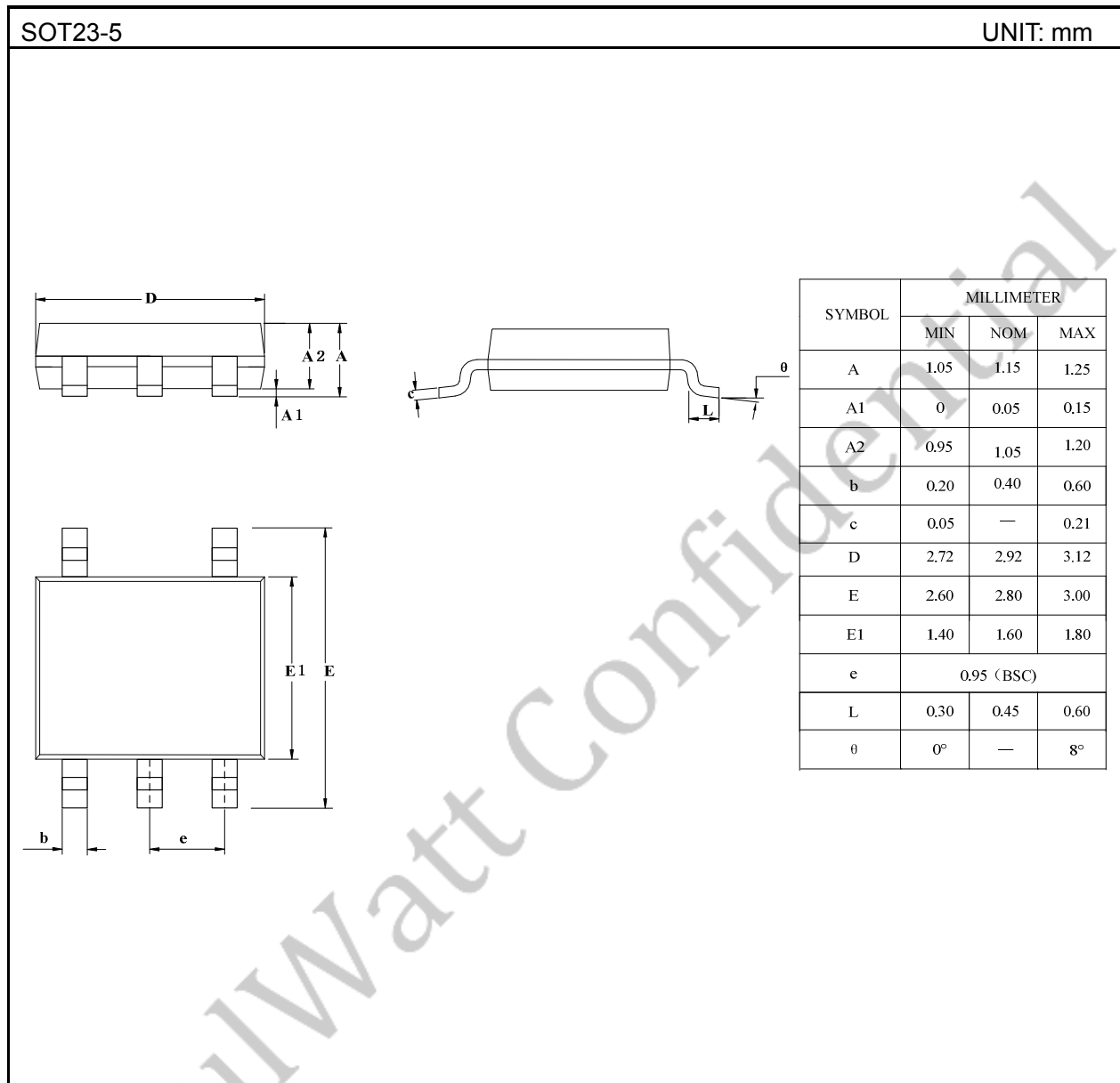

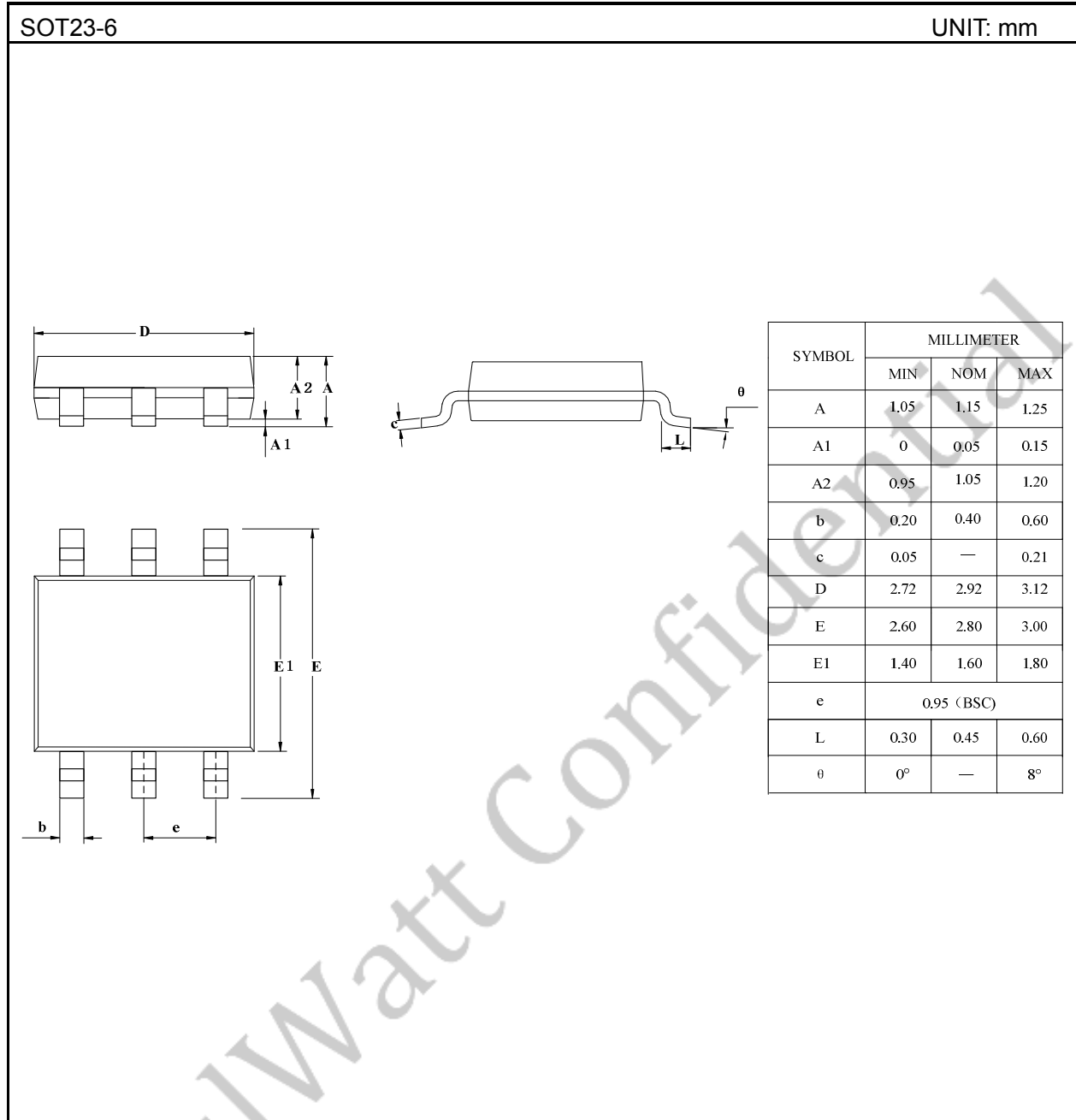

TSOT23-5

UNIT: mm

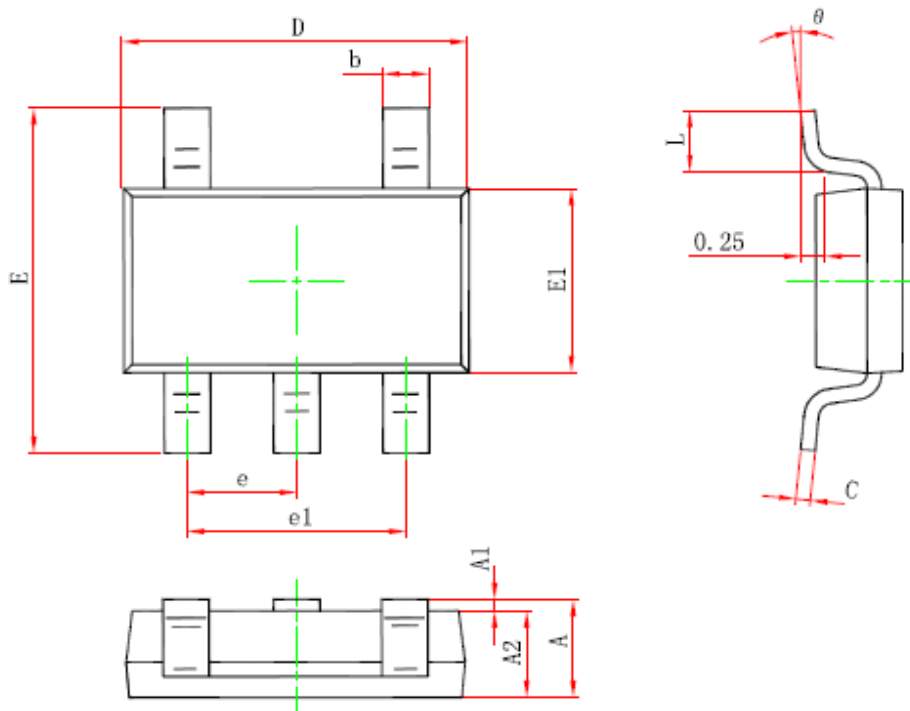

NOTES:

ALL DIMENSIONS MEET JEDEC STANDARD MO-193 AB  
DO NOT INCLUDE MOLD FLASH OR PROTRUSIONS.

Symbol	Dimensions In Millimeters		Dimensions In Inches	
	Min	Max	Min	Max
A	---	0.900	---	0.035
A1	0.020	0.090	0.001	0.004
A2	0.700	0.800	0.028	0.031
b	0.350	0.500	0.014	0.020
c	0.080	0.200	0.003	0.008
D	2.820	3.020	0.111	0.119
E1	1.600	1.700	0.063	0.067
E	2.650	2.950	0.104	0.116
e	0.95 (BSC)		0.037(BSC)	
e1	1.90 (BSC)		0.075(BSC)	
L	0.300	0.600	0.012	0.024
$\theta$	0°	8°	0°	8°



**IMPORTANT NOTICE**

- Joulwatt Technology Inc. reserves the right to make modifications, enhancements, improvements, corrections or other changes without further notice to this document and any product described herein.
- Any unauthorized redistribution or copy of this document for any purpose is strictly forbidden.
- Joulwatt Technology Inc. does not warrant or accept any liability whatsoever in respect of any products purchased through unauthorized sales channel.

JoulWatt Confidential

*Copyright © 2017 JW5211 Incorporated.*

*All rights are reserved by Joulwatt Technology Inc.*