

ML-414

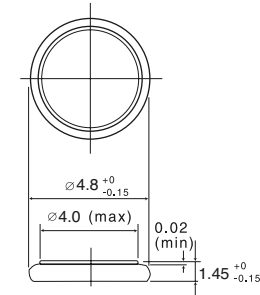

SPECIFICATIONS	
Name	ML-414
Nominal voltage (V)	3
Nominal capacity (mAh)	1.2
Continuous drain (mA)	0.005
Operating temperature (°C)	-20 to +60
Weight (g)	0.09

DISCHARGE CHARACTERISTICS

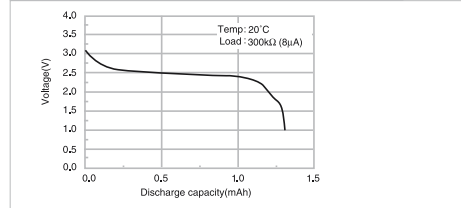

CHARGE VOLTAGE VS. DISCHARGE CAPACITY

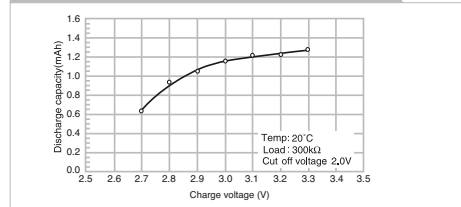

ML-421

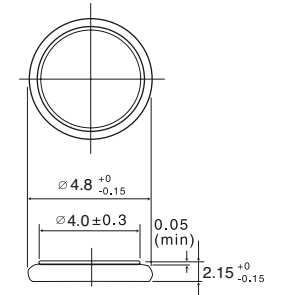

SPECIFICATIONS	
Name	ML-421
Nominal voltage (V)	3
Nominal capacity (mAh)	2.3
Continuous drain (mA)	0.005
Operating temperature (°C)	-20 to +60
Weight (g)	0.11

DISCHARGE CHARACTERISTICS

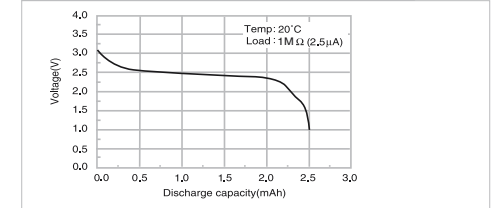

CHARGE VOLTAGE VS. DISCHARGE CAPACITY

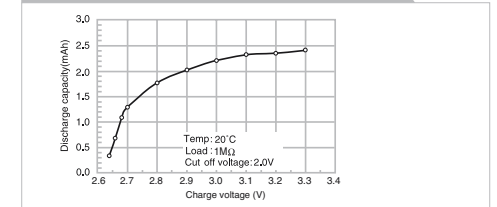

ML-614

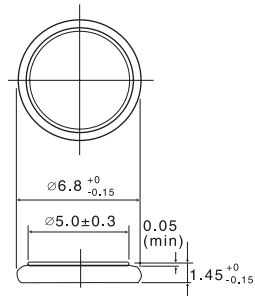

SPECIFICATIONS

Name	ML-614
Nominal voltage (V)	3
Nominal capacity (mAh)	3.4
Continuous drain (mA)	0.01
Operating temperature (°C)	-20 to +60
Weight (g)	0.16

DISCHARGE CHARACTERISTICS

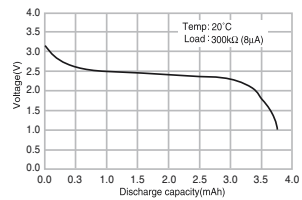

CONSUMPTION CURRENT VS. DURATION TIME

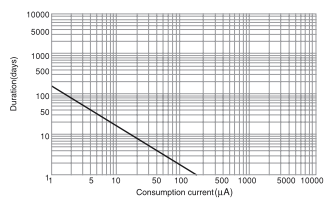

ML-621

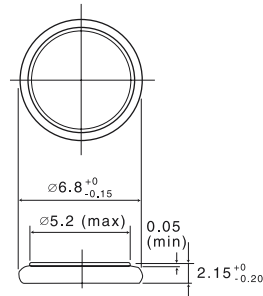

SPECIFICATIONS

Name	ML-621
Nominal voltage (V)	3
Nominal capacity (mAh)	5.0
Continuous drain (mA)	0.01
Operating temperature (°C)	-20 to +60
Weight (g)	0.23

DISCHARGE CHARACTERISTICS

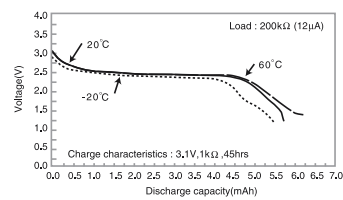

CHARGE CHARACTERISTICS

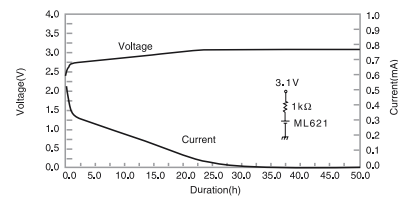

CONSUMPTION CURRENT VS. DURATION TIME

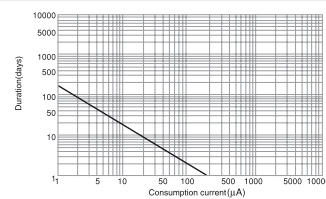

ML-920

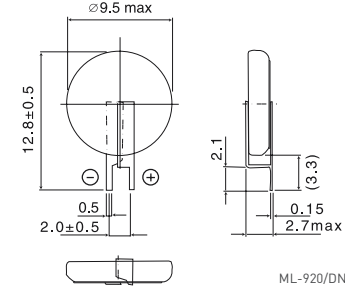

SPECIFICATIONS

Name	ML-920
Nominal voltage (V)	3
Nominal capacity (mAh)	11.0
Continuous drain (mA)	0.03
Operating temperature (°C)	-20 to +60
Weight (g)	0.4

DISCHARGE CHARACTERISTICS

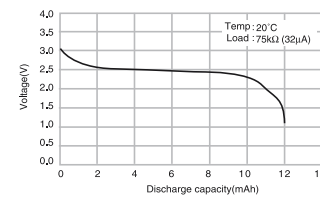

CONSUMPTION CURRENT VS. DURATION TIME

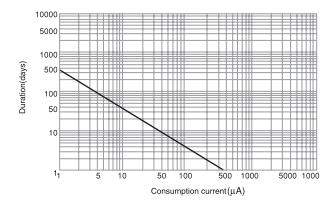

ML-1220

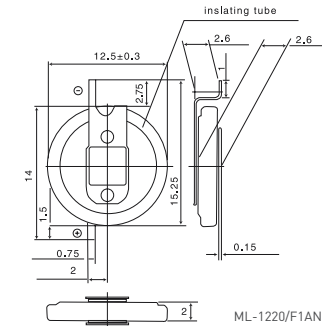

SPECIFICATIONS

Name	ML-1220
Nominal voltage (V)	3
Nominal capacity (mAh)	17.0
Continuous drain (mA)	0.03
Operating temperature (°C)	-20 to +60
Weight (g)	0.8

DISCHARGE CHARACTERISTICS

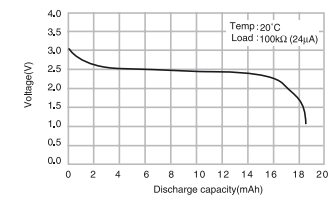

CONSUMPTION CURRENT VS. DURATION TIME

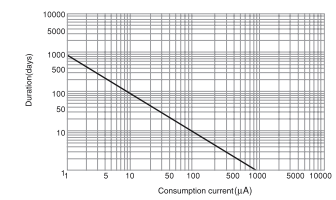

3 MANGANESE RECHARGEABLE LITHIUM BATTERIES (ML SERIES)

ML-2020

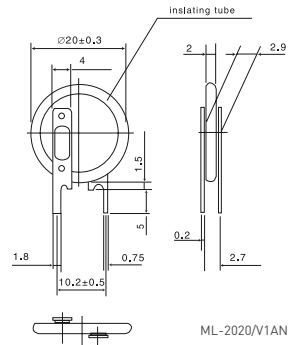

SPECIFICATIONS

Name	ML-2020
Nominal voltage [V]	3
Nominal capacity [mAh]	45
Continuous drain [mA]	0.12
Operating temperature [°C]	-20 to +60
Weight [g]	2.2

DISCHARGE CHARACTERISTICS

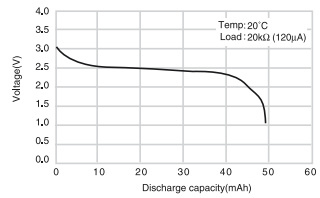

CONSUMPTION CURRENT VS. DURATION TIME

