



Program information

Author : Katona Sándor

Project name : Fűtésvezérlés

Version : 1.0

Module : SR2B121FU

Cycle time in the module : 5 x 2 ms

WATCHDOG action : Inactive

Type of Hardware Input Filtering : Slow (3ms)

Locking of module front panel

Date format : yyyy/mm/dd

Daylight Saving Time change activated

Zone : Europe

Change to Daylight Saving Time : March, Last Sunday

Return to winter time : October, Last Sunday

Comments

Fűtőegységek időben eltolt kapcsolása. Időállítás az előlapi gombokkal.

Minimális idő:

bekapcsolva 10s

kikapcsolva 2s

History

Date	Author	Version	Comment
2022.04.16.	Katona Sándor	1.0	Fűtésvezérlés alaprogram, hővédelemmel és feszültség ellenőrzéssel





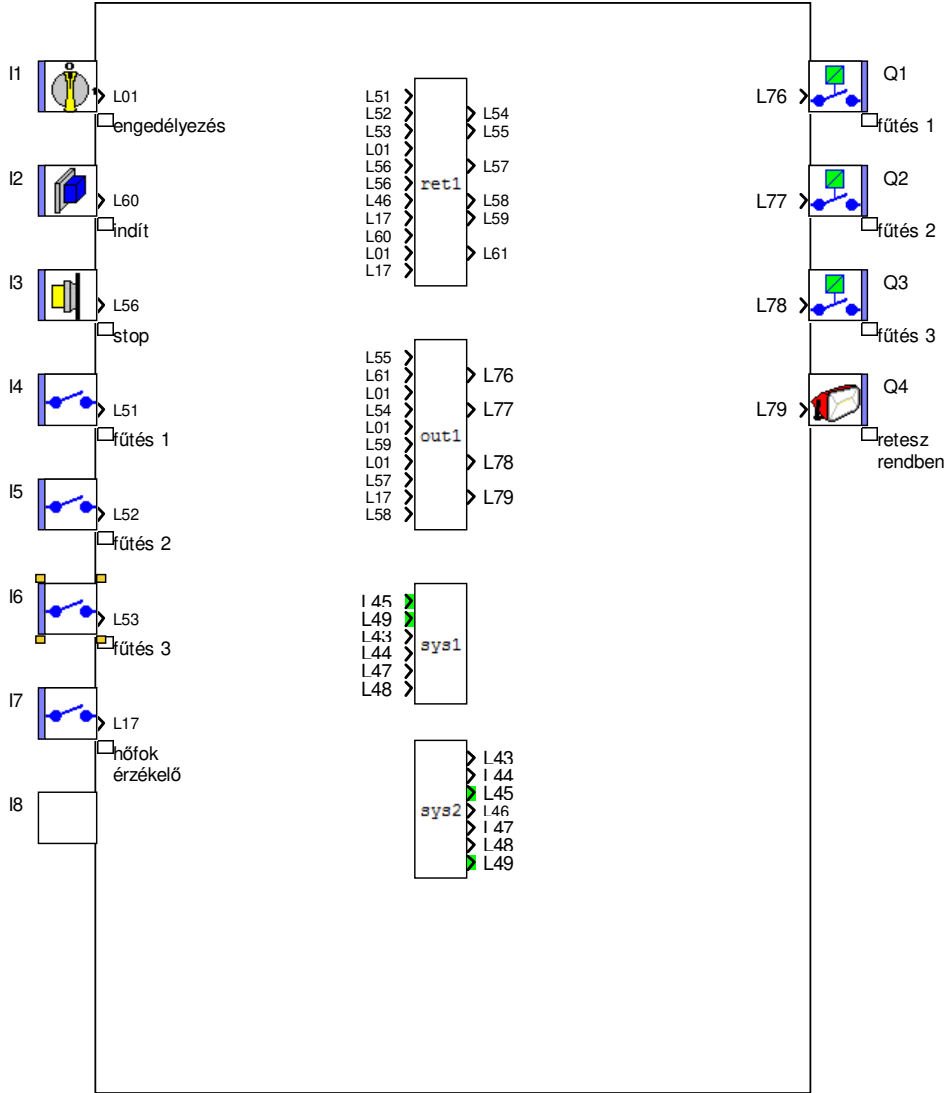



Program diagram













Physical inputs

Input	No	Symbol	Function	Lock	Parameters	Comment
I1	B004		Selector switch	---	No parameters	engedélyezés
I2	B008		Illuminated pushbutton	---	No parameters	indít
I3	B047		Pushbutton	---	No parameters	stop
I4	B005		Contact	---	No parameters	fűtés 1
I5	B006		Contact	---	No parameters	fűtés 2
I6	B007		Contact	---	No parameters	fűtés 3
I7	B054		Contact	---	No parameters	hőfok érzékelő

Module keys

No	Symbol	Function	Comment
02B05		Z1 button	
02B05		Z2 button	
02B05		Z3 button	
02B06		Z4 button	

Physical outputs

Output	No	Symbol	Function	Comment
Q1	B001		Normally open contact	fűtés 1
Q2	B002		Normally open contact	fűtés 2
Q3	B000		Normally open contact	fűtés 3
Q4	B003		Lamp	retesz rendben

Configurable functions

No	Symbol	Function	Lock	Latching	Parameters	Comment
01B00	 TEXT	Text	---	---	See details below	
01B06	 TEXT	Text	---	---	See details below	



No	Symbol	Function	Lock	Latching	Parameters	Comment
01B06		Timer B/H	No	No	On time : 0H 0M 10S Function B	
M01	sys1	time állítás	---	---	See blocks M01BXX	
02B05		Up/down counter	---	No	No parameters	
02B05		Cyclic timing ext setpoint	---	No	Unit : x 1 s Continuous flashing Function Li	
02B06		Up/down counter	---	No	No parameters	
02B06	NUM	Numerical constant	No	---	Value of the constant : 8	8
02B06	NUM	Numerical constant	No	---	Value of the constant : 2	2
02B06		Comparison of 2 values	---	---	VALEUR 1 < VALEUR 2	
02B06		Comparison of 2 values	---	---	VALEUR 1 < VALEUR 2	
M02	sys2	időzítő bállítások	---	---	See blocks M02BXX	
03B04		RS switching	---	---	Priority : RESET has priority	
M03	ret1	reteszelés, ütemadás	---	---	See blocks M03BXX	
04B04		CAM BLOCK	No	No	See details below	
M04	out1	kimenet meghajtás	---	---	See blocks M04BXX	

CAM BLOCK

M04B043		CAM BLOCK						
Position	S1	S2	S3	S4	S5	S6	S7	S8
1	1	0	0	0	0	0	0	0
2	0	1	0	0	0	0	0	0
3	0	0	1	0	0	0	0	0

FBD TEXT (Text)

M01B000		Text													
F	ű	t	A	s	i	d	ő	b	e	á	l	l	é	t	.
Y	Y	Y	Y	.	M	M	.	D	D	/	H	H	:	M	M
Modification authorized for YYYY.MM.DD Date															
Modification authorized for HH:MM Hour															



M01B065										TEXT	Text									
				B	e	á	l	l	z	t	á	s								
F	ü	t	A	s				s	z	ü	n	e	t							
+	i	d	ö	-					+	i	d	ö	-							
*	*	#	4	*	*		*	*	#	5	*	*	-							
Modification authorized for #4 M02 Current value																				
Modification authorized for #5																				