

3·1/2 DIGIT SINGLE CHIP DIGITAL MULTIMETER LSI

■ GENERAL DESCRIPTION

The NJU9207/9208 are 3·1/2 digit single chip digital multimeter LSIs with auto-ranging function containing 3·1/2 digit dual-slope A/D converter, voltage reference, controller, oscillator, battery-life detector and LCD driver.

The NJU9207/9208 are most suitable for the pocket type digital multimeter because of low operating voltage(3V) and functions of auto-ranging, display hold, LCD display, piezo buzzer direct driving and battery life indicator.

The NJU9208 rotates the pad location 90 deg. against the NJU9207.

■ PACKAGE OUTLINE

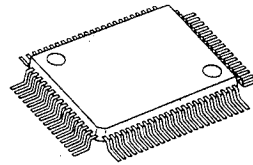

NJU9207/08F

5

■ FEATURES

- Low Operating Current
- Low Operating Voltage (3V)
- Dual-slope A/D Converter
- Auto-ranging
- Holding Function (Data, Range)
- LCD Display Direct Driving
- Voltage Doubler for LCD Driver On-chip
- Voltage Regulator for LCD Driving
- Piezo Buzzer Direct Driving
- Power-on Initialize
- Battery-life Detector
- Package Outline -- QFP 80
- C-MOS Technology

■ PIN CONFIGURATION

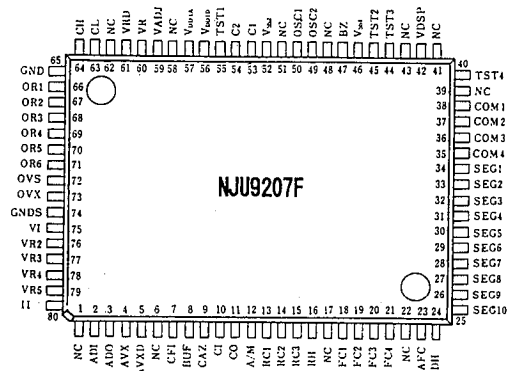

■ BLOCK DIAGRAM

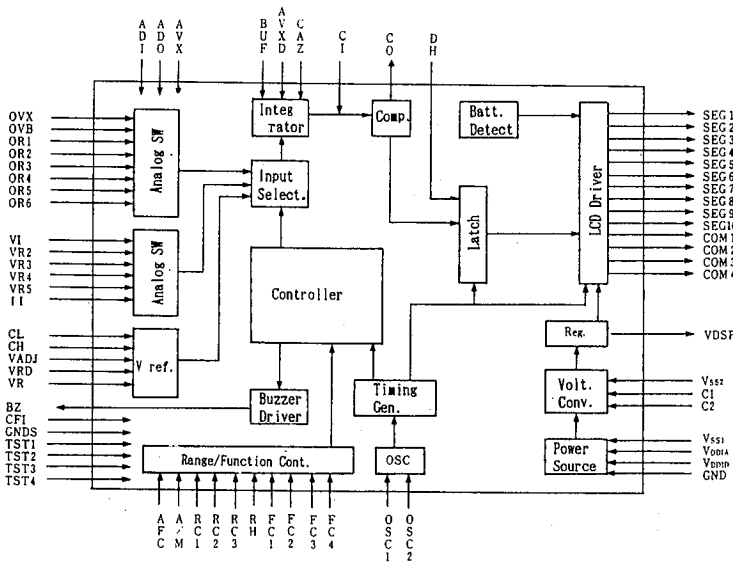

■ TERMINAL DESCRIPTION

NJU9207	NJU9208	SYMBOL	F U N C T I O N
2	62	AD1	AC → DC Conversion Input Terminal
3	63	ADD	AC → DC Conversion Output Terminal
4	64	AVX	ADC "+" Input Terminal in AC Voltage Input
5	65	AVXD	ADC "-" Input Terminal in AC Voltage Input
7	67	CF1	Noise Filter Capacitor Connecting Terminal
8	68	BUF	Buffer Amplifier Output
9	69	CAZ	Auto-Zero Capacitor Connecting Terminal
10	70	CI	Integral Capacitor Connecting Terminal
11	71	CO	Comparator Output Terminal
12	72	A/M	Auto/Manual Selecting Input Terminal H Level: Auto L Level: Manual
13-15	73-75	RC1-RC3	Range Selecting Terminals (Note 1)
16	76	RH	Range Hold Terminal L Level: Range Hold (Note 1)
24	4	DH	Display Data Hold Mode Selecting Terminal : Toggle Mode
18-21	78-80,1	FC1-FC4	Function Selecting Terminals (Note 1)
23	3	AFC	Range Limit Mode Selecting Terminal H Level: Range Limit Mode (Note 1) L Level: Full Range Mode
34-25	14-5	SEG1-10	LCD Segment Driver Output Terminals
38-35	18-15	COM1-4	LCD Common Driver Output Terminals
42	22	VDSP	LCD Driving Voltage Monitor Terminal
47	27	BZ	Piezo Buzzer Driving Output Terminals
49,50	29,30	OSC2, OSC1	Quartz Crystal Connecting Terminals
53,54	33,34	C1,C2	Voltage Doubler Capacitor Connecting Terminals
59	39	VADJ	Reference Voltage Adjustment Terminal
60	40	VR	Reference Voltage Output Terminal
61	41	VRD	Reference Voltage Monitor Terminal
63,64	43,44	CL,CH	Reference Capacitor Connecting Terminals
66-71	46-51	OR1-6	Reference Resistance Connecting Terminals for Resistance Measurement
72	52	OVS	Reference Voltage Input Terminal for Resistance Measurement
73	53	OVX	Measuring Voltage Input Terminal for Resistance Measurement
75	55	VI	Voltage Measurement Input Terminal
76-79	56-59	VR2-VR5	Bleeder Resistance Connecting Terminals
80	60	II	Current Measurement Input Terminal
55,45	35,25	TST1,2	Test Terminals 1, 2
44,40	24,20	TST3,4	Test Terminals 3, 4
46	26	V _{SS1}	Analog, Digital GND Terminal 0V
52	32	V _{SS2}	LCD Driving Voltage Supply Terminal -3V
56	36	V _{DD1D}	Digital Block Voltage Supply Terminal +3V
57	37	V _{DD1A}	Analog Block Voltage Supply Terminal +3V
65	45	GND	Analog Block Center point Voltage Supply Terminal +1.5V
74	54	GNDS	GND Sensing Terminal in Integral Operation

(Note 1) With Pull-Up resistance except the A/M terminal.

FUNCTIONAL DESCRIPTION

(1) MEASUREMENT FUNCTION

Measurement Function	Range	Auto or Manual
DC Voltage	200mV~2000V 5-Range	Auto Range
AC Voltage	2V ~ 2000V 4-Range	Auto Range
Resistance	100Ω~20MΩ 6-Range	Auto Range
DC Current	2mA ~ 20A 5-Range	Manual Range
AC Current	2mA ~ 20A 5-Range	Manual Range
Diode Check		
Continuity Check		

5

(2) MEASUREMENT FUNCTION SELECTION (By the FC1 ~ FC4 terminals input)

FUNCTION	FC1	FC2	FC3	FC4
DCV	H	H	H	H
ACV	L	H	H	H
DCI	H	L	H	H
ACI	L	L	H	H
Ω	H	H	L	H
▶	H	L	L	H
CONTI	H	H	H	L

(3) MEASUREMENT FUNCTION SELECTION SWITCH

The mechanical lock type or rotary type switch are required.

(4) THE KEY INPUT CONFIRMATION SOUND OF SWITCH OPERATION / SYSTEM RESET

Piezo buzzer driving signal for the key input confirmation sound and system reset signal are output, when the switch is operated.

a) THE KEY INPUT CONFIRMATION SOUND SIGNAL(2kHz)

2kHz clock is output from BZ terminal about 31.25ms period at the rising or falling edge of input signals to the FC1 ~ FC4 terminals. This signal can drive a Piezo Buzzer directly.

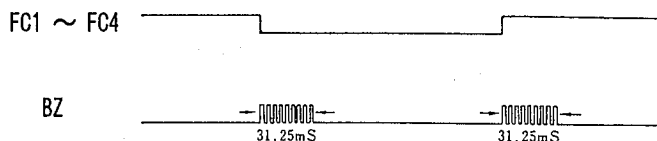

b) SYSTEM RESET SIGNAL

The range-set, counter-reset, data-hold-release and auto-reset are performed synchronizing the rising or falling edge of input signals to the FC1 ~ FC4 terminals.

[Range-Set]

When the function was changed in the auto-range mode, the range is set depending on the [AFC] terminal level as follows:

FUNCTION	[AFC]:[L]		[AFC]:[H]	
	RANGE	POINT	RANGE	POINT
DCV	200mV	P1	2 V	P3
ACV	2 V	P3	2 V	P3
DCI	200mA	P1	200mA	P1
ACI	200mA	P1	200mA	P1
Ω	200 Ω	P1	2k Ω	P3
\rightarrow	2 V	P3	2 V	P3
CONT I	2k Ω	P3	2k Ω	P3

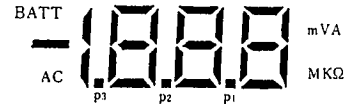
[COUNTER RESET]

When the function is changed even if the A/D conversion period, the counter reset signal is output internally and the LSI is initialized. Afterward, the A/D conversion is start from auto-zero cycle.

FC1 ~ FC4

Integration Output

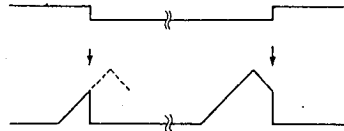
(5) CONTINUITY CHECK FUNCTION

When select continuity check function, 2k Ω range of k Ω function is set automatically. If the measured value is under 300 Ω , the buzzer sound is output continuously and the measured resistor value is displayed.

(6) DIODE CHECK FUNCTION

When select diode check function, 2k Ω range of k Ω function is set automatically and measured a diode forward voltage by supplied 1.5V. If the input terminals are open, the voltage corresponding to the battery voltage is displayed.

(7) FULL AUTO-RANGE FUNCTION (A/M=H Level)

① The following flow is performed by range control terminal (RC1):

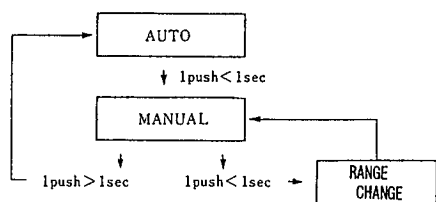

Apply the Momentary switch for the range control.

Full Range Mode (AFC=L Level)

FUNCTION	A U T O		M A N U A L		RANGE CONTROL
		1 PUSH	1 PUSH (<1sec.)		
D C V	RNG1 ~ RNG5	→ HOLD	RNGi → RNGi+1 (RNG5 → RNG1)		200mV ~ 2000V
A C V	RNG1 ~ RNG4	→ HOLD	RNGi → RNGi+1 (RNG4 → RNG1)		2V ~ 2000V
D C I	Fix to RNG1	RNG1	RNG1		200mA
A C I	Fix to RNG1	RNG1	RNG1		200mA
Ω	RNG1 ~ RNG6	→ HOLD	RNGi → RNGi+1 (RNG6 → RNG1)		200Ω ~ 20MΩ

Range Control Mode (AFC=H Level)

FUNCTION	A U T O		M A N U A L		RANGE CONTROL
		1 PUSH	1 PUSH (<1sec.)		
D C V	RNG1 ~ RNG4	→ HOLD	RNGi → RNGi+1 (RNG4 → RNG1)		2V ~ 2000V
A C V	RNG1 ~ RNG4	→ HOLD	RNGi → RNGi+1 (RNG4 → RNG1)		2V ~ 2000V
D C I	Fix to RNG1	RNG1	RNG1		200mA
A C I	Fix to RNG1	RNG1	RNG1		200mA
Ω	RNG1 ~ RNG4	→ HOLD	RNGi → RNGi+1 (RNG4 → RNG1)		2kΩ ~ 2000kΩ

② AUTO-RETURN FUNCTION

When the range selecting terminal is kept L level over than 1 sec or a function is changed by FC1~FC4 terminals, the range can be changed a function to auto range from any fixed range.

③ RANGE HOLD FUNCTION

When the range hold terminal is L level, the range is fixed to the operated range. And the input signal to the range selecting terminal (RC1) is disregarded.

④ THE RANGE CONTROL CONFIRMATION SIGNAL

2kHz clock is output on BZ terminal about 31.25ms period at the falling edge of the RC1 terminal input. This signal can drive a Piezo Buzzer directly.

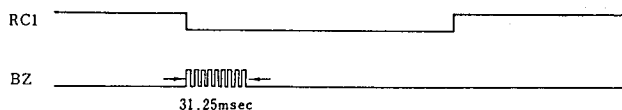

(8) MANUAL RANGE FUNCTION (A/M=L Level)

① Manual range is selected by RC1~RC3 as follows:

RC1	RC2	RC3	DCV	ACV	DCI, ACI	Ω
H	H	H	RNG2, 2V	RNG1, 2V	RNG1, 2mA	RNG2, 2K Ω
L	H	H	RNG3, 20V	RNG2, 20V	RNG2, 20mA	RNG3, 20K Ω
H	L	H	RNG4, 200V	RNG3, 200V	RNG3, 200mA	RNG4, 200K Ω
L	L	H	RNG5, 2000V	RNG4, 2000V	RNG4, 2000mA	RNG5, 2000K Ω
H	H	L	RNG5, 2000V	RNG4, 2000V	RNG5, 20A	RNG6, 20M Ω
L	H	L	RNG1, 200mV	RNG1, 2V	RNG1, 2mA	RNG1, 200 Ω

② MODE CHANGE OPERATION CONFIRMATION SOUND SIGNAL (2kHz)

2kHz clock is output on BZ terminal about 31.25ms period at the rising or falling edge of RC1 ~ RC3 terminals input. This signal can drive a Piezo Buzzer directly.

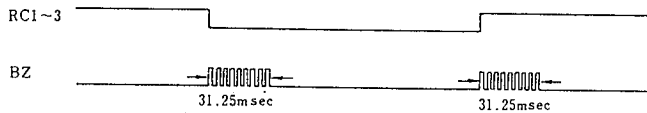

(9) CHATTER-FREE FUNCTION

All input terminals for control are build with the chatter-free circuits which eliminate chattering input less than 62.5ms.

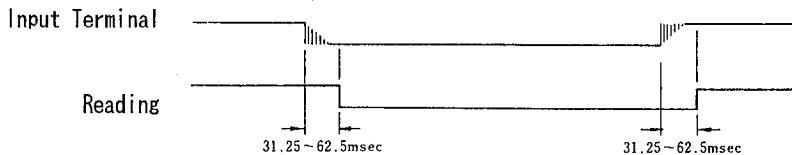

(10) BUZZER DRIVING SIGNAL

Adding to the switch operation confirmation signal output by FC1 ~ FC4 and RC1 ~ RC3, the buzzer driving signals is also output at the following conditions.

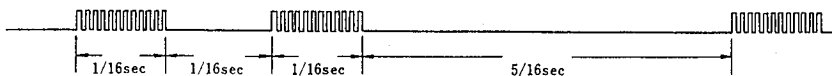
 ① Alarm sound for over range (except Ω)

② Confirmation for continuity



(11) LCD DISPLAY FUNCTION



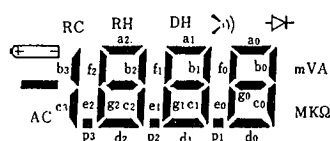
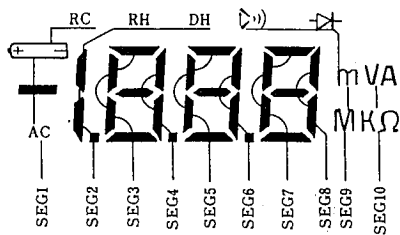
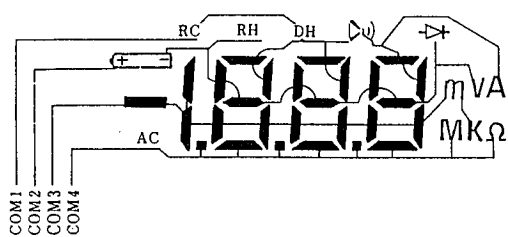







- LCD Display pattern



- Segment Assignment

	SEG1	SEG2	SEG3	SEG4	SEG5	SEG6	SEG7	SEG8	SEG9	SEG10
COM 1	RC	DH	a2	b2	a1	b1	a0	b0		A
COM 2	BATT	RH	f2	g2	f1	g1	f0	g0		V
COM 3	-	b3/c3	e2	c2	e1	c1	e0	c0	m	K
COM 4	AC	p3	d2	p2	d1	p1	d0		M	Ω

• Display Mark Explanation

- ① [BATT MARK] ()
 [] is displayed when either the V_{DD} or V_{SS} becomes lower than 1.1V~1.3V.
- ② [-]
 [-] is displayed when the DCV or DCI input is "-".
- ③ [AC]
 [AC] is displayed when the ACV or ACI mode is selected.
- ④ [RH]
 [RH] is displayed when the RH terminal is input L level in the AUTO range(A/M=H) mode.
- ⑤ [RC]
 [RC] is displayed when the range is controlled by RC1 terminal in the AUTO range(A/M=H) mode.
- ⑥  
  is displayed when the continuity check function is selected.
- ⑦  
  is displayed when the diode check function is selected.
- ⑧ [DH]
 [DH] is displayed and the data is held when the DH switch is pushed a time. When DH switch is pushed once again, [DH] is disappeared and the data holding is released.
- ⑨ [mV]
 [mV] is displayed when 200mV range of DCV is selected.
- ⑩ [V]
 [V] is displayed when 2V, 20V, 200V and 2000V range of DCV and ACV is selected.
- ⑪ [Ω]
 [Ω] is displayed when the 200 Ω range is selected.
- ⑫ [k Ω]
 [k Ω] is displayed when 2k Ω , 20k Ω , 200k Ω and 2000k Ω range and the continuity check function is selected.
- ⑬ [M Ω]
 [M Ω] is displayed when the 20M Ω range is selected.
- ⑭ [mA]
 [mA] is displayed when mA range of DC and AC is selected.
- ⑮ [A]
 [A] is displayed when 20A range of DC and AC is selected.
- ⑯ Over flow display
 When an input signal is over flow, the display indicates [1000] with blinking most significant digit, though the internal counter counts up to [2000]. And if the input value becomes over than [2000] count, the lower 3 digit always displays [000] .
- ⑰ The Polarity [-] display
 [-] is not displayed when the ACV, ACI, Ω and CONT1 mode is selected and display value is [000] .
- ⑱ Data hold
 When the DH terminal is L level, the data is held and [DH] is displayed. And when the terminal is L level again, the data hold mode is released and [DH] is disappeared. And also, the data hold is released by function and range operation.

(12) Power-On Initialization

When turn on the power, the power-on-initialization circuits performs

- All LCD Display ON
- Piezo buzzer driving signal output (about 62.5ms)
- Initialize the internal circuits.

■ ABSOLUTE MAXIMUM RATINGS

(Ta=25°C)

PARAMETER		SYMBOL	RATINGS	UNIT
Supply Voltage		$V_{DD1}-V_{SS1}$	4.0	V
		$GND-V_{SS1}$	2.0	
Control Terminal Input Voltage		V_{ID}	$V_{DD1} \sim V_{SS1}$	V
Analog Terminal Input Voltage		V_{IA}	$V_{DD1} \sim V_{SS1}$	V
Soldering Temperature		T_{SOL}	260	°C
Soldering Time		t_{SOL}	10	sec
Operating Temperature Range		T_{opr}	0 ~ + 50	°C
Storage Temperature Range		T_{stg}	- 40 ~ +125	°C
Input Current	Power Supply Term.	I_{DD}, I_{GND}, I_{SS}	± 50	mA
	ORI Terminal	I_{ORI}	± 50	
	Oth. Terminals	I_L, I_O	± 10	

5
■ ELECTRICAL CHARACTERISTICS

 (Ta=25°C, $V_{DD1}=3.0V$, $GND=1.5V$, DC 200mV Range)

PARAMETER	SYMBOL	CONDITIONS	MIN	TYP	MAX	UNIT	
Operating Voltage	V_{DD1}	*1	1.8	3.0	3.6	V	
	GND		0.9	1.5	1.8		
Operating Current	I_{DD}				1.0	mA	
Sampling Time	T_S			100		ms	
Sampling Rate	N_r			2		Times/ sec	
Linearity	L_{in}	R1=10MΩ R1=series input resistor			±0.2	%F.S	
Rollover Error	E_P				±0.1		
Zero Input Reading	Zero		0	0	0		V
Step Up Voltage	V_{SS2}	V_{SS2} Terminal		- 2.8		V	
Input Voltage	V_{IH}	FC1~FC4, RC1~RC4, RH, AFC, DH, A/M Terminals	2.45			V	
	V_{IL}				0.55		
Input Pull-up Resistance	R_i	FC1~FC4, RC1~RC4, RH, AFC, DH Terminals	100	300	500	kΩ	
Buzzer Driving Current	I_{OH}	BZ Terminal	$V_{OH}=2.7V$	0.25	0.75	mA	
	I_{OL}		$V_{OL}=0.3V$	0.25	0.75		
Open-circuit Voltage for OHM Measurements	V_{Ω}	200Ω~20MΩ		0.43		V	
Output Voltage	V_H	COM1~COM4		-1.03		V	
	V_L	SEG1~SEG4		-2.07			
	V_{DSP}	(LCD driving waveform)		-3.10			
Input Leakage Current	I_{IL}	V_i Terminal	$V_{in}=0mV$		1	± 10	pA
			$V_{in}=\pm 200mV$			±100	

 * 1) V_{DD1A} and V_{DD1D} are same voltage. V_{DD1} is a generic term.

■ LCD Driving Waveform
(1/4duty, DC200mV Range, Vin=0mV)

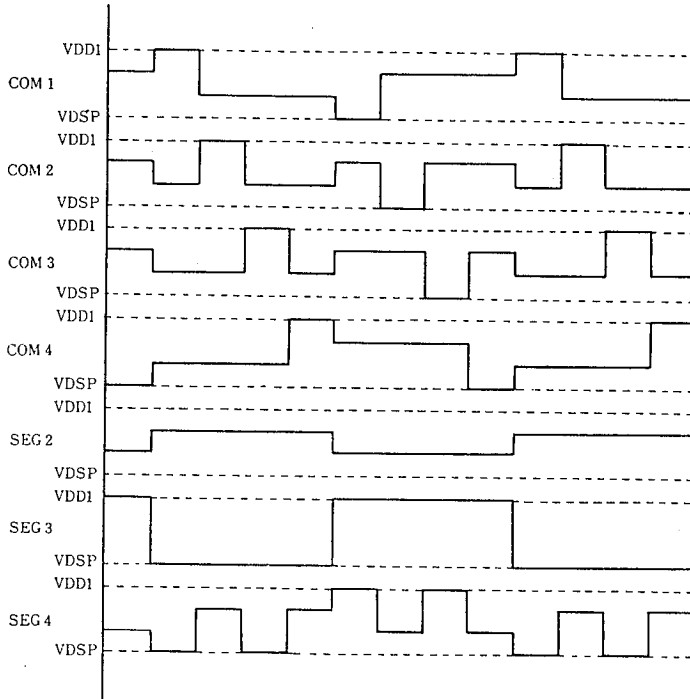

5

■ APPLICATION CIRCUIT (Auto-Range DMM)

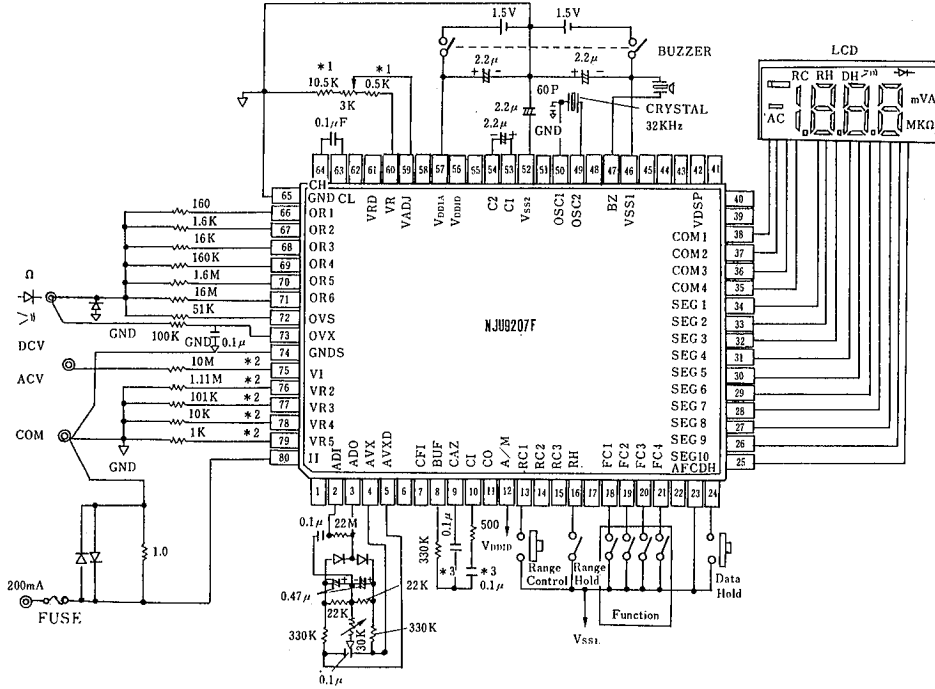

5

- *1 : Accuracy : less than $\pm 0.2\%$
The relative error of temperature characteristics : less than $\pm 50\text{ppm}$.
- *2 : Accuracy : less than $\pm 0.5\%$
No mentioned resistor : less than $\pm 1.0\%$
- *3 : Polypropylene film capacitor
Quartz Crystal : 32.768kHz, C1=less than 30k Ω

MEMO

[CAUTION]

The specifications on this databook are only given for information, without any guarantee as regards either mistakes or omissions. The application circuits in this databook are described only to show representative usages of the product and not intended for the guarantee or permission of any right including the industrial rights.

This datasheet has been downloaded from:

www.DatasheetCatalog.com

Datasheets for electronic components.