



1MHz, 45µA, CMOS, Rail-to-Rail OPERATIONAL AMPLIFIERS

FEATURES

- **LOW I_Q: 45µA typical**
- **LOW COST**
- **RAIL-TO-RAIL INPUT AND OUTPUT**
- **SINGLE SUPPLY: +2.1V to +5.5V**
- **INPUT BIAS CURRENT: 0.5pA**
- **MicroSIZE PACKAGES: SC70-5, SOT23-8 and TSSOP-14**
- **HIGH SPEED: POWER WITH BANDWIDTH: 1MHz**

APPLICATIONS

- **PORTABLE EQUIPMENT**
- **BATTERY-POWERED EQUIPMENT**
- **SMOKE ALARMS**
- **CO DETECTORS**
- **MEDICAL INSTRUMENTATION**

DESCRIPTION

The OPA348 series amplifiers are single supply, low-power, CMOS op amps in micro packaging. Featuring an extended bandwidth of 1MHz, and a supply current of 45µA, the OPA348 series is useful for low-power applications on single supplies of 2.1V to 5.5V.

Low supply current of 45µA, and an input bias current of 0.5pA, make the OPA348 series an optimal candidate for low-power, high-impedance applications such as smoke detectors and other sensors.

The OPA348 is available in the miniature SC70-5, SOT23-5 and SO-8 packages. The OPA2348 is available in SOT23-8 and SO-8 packages, and the OPA4348 is offered in space-saving TSSOP-14 and SO-14 packages. The extended temperature range of -40°C to +125°C over all supply voltages offers additional design flexibility.

PACKAGES	OPA348	OPA2348	OPA4348
SOT23-5	X		
SOT23-8		X	
SO-8	X	X	
TSSOP-14			X
SO-14			X
SC70-5	X		

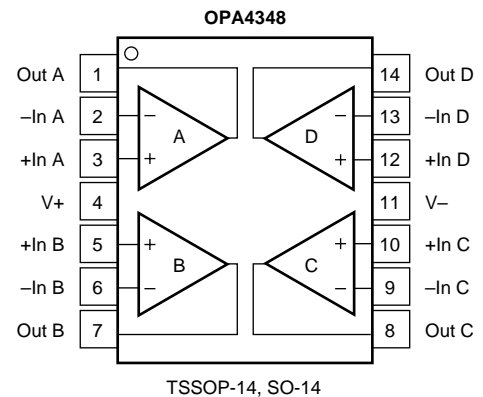
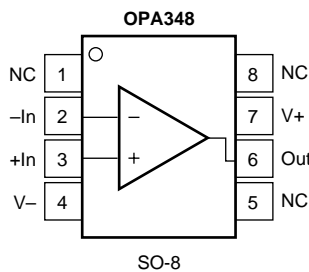
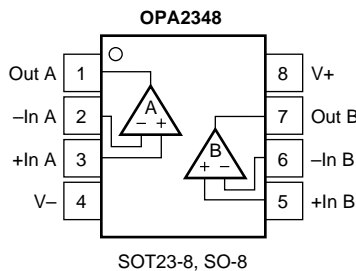
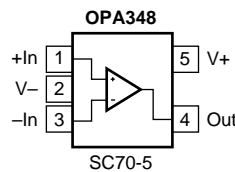
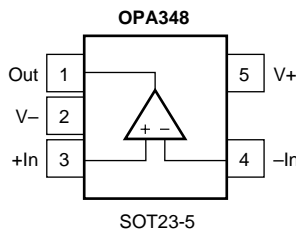

Please be aware that an important notice concerning availability, standard warranty, and use in critical applications of Texas Instruments semiconductor products and disclaimers thereto appears at the end of this data sheet.

ABSOLUTE MAXIMUM RATINGS⁽¹⁾

Supply Voltage, V ₋ to V ₊	7.5V
Signal Input Terminals, Voltage ⁽²⁾	(V ₋) - 0.5V to (V ₊) + 0.5V
Current ⁽²⁾	10mA
Output Short-Circuit ⁽³⁾	Continuous
Operating Temperature	-65°C to +150°C
Storage Temperature	-65°C to +150°C
Junction Temperature	150°C
Lead Temperature (soldering, 10s)	300°C

NOTES: (1) Stresses above these ratings may cause permanent damage. Exposure to absolute maximum conditions for extended periods may degrade device reliability. These are stress ratings only. Functional operation of the device at these conditions, or beyond the specified operating conditions, is not implied. (2) Input terminals are diode-clamped to the power-supply rails. Input signals that can swing more than 0.5V beyond the supply rails should be current-limited to 10mA or less. (3) Short-circuit to ground, one amplifier per package.



ELECTROSTATIC DISCHARGE SENSITIVITY

This integrated circuit can be damaged by ESD. Texas Instruments recommends that all integrated circuits be handled with appropriate precautions. Failure to observe proper handling and installation procedures can cause damage.

ESD damage can range from subtle performance degradation to complete device failure. Precision integrated circuits may be more susceptible to damage because very small parametric changes could cause the device not to meet its published specifications.

PACKAGE/ORDERING INFORMATION

PRODUCT	PACKAGE-LEAD	PACKAGE DESIGNATOR ⁽¹⁾	SPECIFIED TEMPERATURE RANGE	PACKAGE MARKING	ORDERING NUMBER ⁽²⁾	TRANSPORT MEDIA, QUANTITY
Single						
OPA348AI	SOT23-5	DBV	-40°C to +125°C	A48	OPA348AIDBVT	Tape and Reel, 250
"	"	"	"	"	OPA348AIDBVR	Tape and Reel, 3000
OPA348AI	SO-8	D	-40°C to +125°C	348A	OPA348AID	Tubes, 100
"	"	"	"	"	OPA348AIDR	Tape and Reel, 2500
OPA348AI	SC70-5	DCK	-40°C to 125°C	S48	OPA348AIDCKT	Tape and Reel, 250
"	"	"	"	"	OPA348AIDCKR	Tape and Reel, 3000
Dual						
OPA2348AI	SOT23-8	DCN	-40°C to +125°C	B48	OPA2348AIDCNT	Tape and Reel, 250
"	"	"	"	"	OPA2348AIDCNR	Tape and Reel, 3000
OPA2348AI	SO-8	D	-40°C to +125°C	2348A	OPA2348AID	Tubes, 100
"	"	"	"	"	OPA2348AIDR	Tape and Reel, 2500
Quad						
OPA4348AI	SO-14	D	-40°C to +125°C	OPA4348	OPA4348AID	Tubes, 58
"	"	"	"	"	OPA4348AIDR	Tape and Reel, 2500
OPA4348AI	TSSOP-14	PW	-40°C to +125°C	4348A	OPA4348AIPWT	Tubes, 250
"	"	"	"	"	OPA4348AIPWR	Tape and Reel, 2500

NOTES: (1) For the most current specifications and package information, refer to our web site at www.ti.com. (2) Models labeled with "T" indicate smaller quantity tape and reel, "R" indicates large quantity tape and reel and "D" indicates tubes of specified quantity.

ELECTRICAL CHARACTERISTICS: $V_S = 2.5V$ to $5.5V$

Boldface limits apply over the specified temperature range, $T_A = -40^{\circ}C$ to $+125^{\circ}C$

At $T_A = +25^{\circ}C$, $R_L = 100k\Omega$ connected to $V_S/2$ and $V_{OUT} = V_S/2$, unless otherwise noted.

PARAMETER	CONDITION	OPA348 OPA2348 OPA4348			UNITS
		MIN	TYP	MAX	
OFFSET VOLTAGE Input Offset Voltage V_{OS} Over Temperature Drift dV_{OS}/dT vs Power Supply PSRR Over Temperature Channel Separation, dc $f = 1kHz$	$V_S = 5V, V_{CM} = (V-) + 0.8V$		1	5	mV
	$V_S = 2.5V$ to $5.5V, V_{CM} < (V+) - 1.7V$		4	6	mV
	$V_S = 2.5V$ to $5.5V, V_{CM} < (V+) - 1.7V$		60	175	$\mu V/V$
			0.2	300	$\mu V/V$
			134		dB
INPUT VOLTAGE RANGE Common-Mode Voltage Range V_{CM} Common-Mode Rejection Ratio over Temperature over Temperature	$(V-) - 0.2V < V_{CM} < (V+) - 1.7V$	$(V-) - 0.2$	70	$(V+) + 0.2$	V
	$(V-) < V_{CM} < (V+) - 1.7V$		66		dB
	$V_S = 5.5V, (V-) - 0.2V < V_{CM} < (V+) + 0.2V$		60	71	dB
	$V_S = 5.5V, (V-) < V_{CM} < (V+)$		56		dB
INPUT BIAS CURRENT Input Bias Current I_B Input Offset Current I_{OS}			± 0.5	± 10	pA
			± 0.5	± 10	pA
INPUT IMPEDANCE Differential Common-Mode			$10^{13} \parallel 3$		$\Omega \parallel pF$
			$10^{13} \parallel 6$		$\Omega \parallel pF$
NOISE Input Voltage Noise, $f = 0.1Hz$ to $10Hz$ Input Voltage Noise Density, $f = 1kHz$ e_n Input Current Noise Density, $f = 1kHz$ i_n	$V_{CM} < (V+) - 1.7V$		10		$\mu Vp-p$
			35		nV/\sqrt{Hz}
			4		fA/\sqrt{Hz}
OPEN-LOOP GAIN Open-Loop Voltage Gain A_{OL} over Temperature over Temperature	$V_S = 5V, R_L = 100k\Omega, 0.025V < V_O < 4.975V$	94	108		dB
	$V_S = 5V, R_L = 100k\Omega, 0.025V < V_O < 4.975V$	90			dB
	$V_S = 5V, R_L = 5k\Omega, 0.125V < V_O < 4.875V$	90	98		dB
	$V_S = 5V, R_L = 5k\Omega, 0.125V < V_O < 4.875V$	88			dB
OUTPUT Voltage Output Swing from Rail over Temperature over Temperature Short-Circuit Current I_{SC} Capacitive Load Drive C_{LOAD}	$R_L = 100k\Omega, A_{OL} > 94dB$		18	25	mV
	$R_L = 100k\Omega, A_{OL} > 90dB$			25	mV
	$R_L = 5k\Omega, A_{OL} > 90dB$		100	125	mV
	$R_L = 5k\Omega, A_{OL} > 88dB$			125	mV
			± 10		mA
			See Typical Characteristics		
FREQUENCY RESPONSE Gain-Bandwidth Product GBW Slew Rate SR Settling Time, 0.1% t_s 0.01% Overload Recovery Time Total Harmonic Distortion + Noise THD+N	$C_L = 100pF$				MHz
	$G = +1$		1		
	$V_S = 5.5V, 2V$ Step, $G = +1$		0.5		$V/\mu s$
	$V_S = 5.5V, 2V$ Step, $G = +1$		5		μs
	$V_{IN} \cdot \text{Gain} > V_S$		7		μs
	$V_S = 5.5V, V_O = 3Vp-p, G = +1, f = 1kHz$		1.6		μs
			0.0023		%
POWER SUPPLY Specified Voltage Range V_S Minimum Operating Voltage Quiescent Current (per amplifier) I_Q over Temperature		2.5		5.5	V
			2.1 to 5.5		V
			45	65	μA
	$I_O = 0$			75	μA
TEMPERATURE RANGE Specified Range Operating Range Storage Range Thermal Resistance θ_{JA} SOT23-5 Surface-Mount SOT23-8 Surface-Mount MSOP-8 Surface-Mount SO-8 Surface-Mount SO-14 Surface-Mount TSSOP-14 Surface-Mount SC70-5 Surface-Mount		-40		125	$^{\circ}C$
		-65		150	$^{\circ}C$
		-65		150	$^{\circ}C$
			200		$^{\circ}C/W$
			150		$^{\circ}C/W$
			150		$^{\circ}C/W$
			150		$^{\circ}C/W$
			100		$^{\circ}C/W$
			100		$^{\circ}C/W$
			250		$^{\circ}C/W$

TYPICAL CHARACTERISTICS

At $T_A = +25^\circ\text{C}$, $R_L = 100\text{k}\Omega$ connected to $V_S/2$ and $V_{OUT} = V_S/2$, unless otherwise noted.

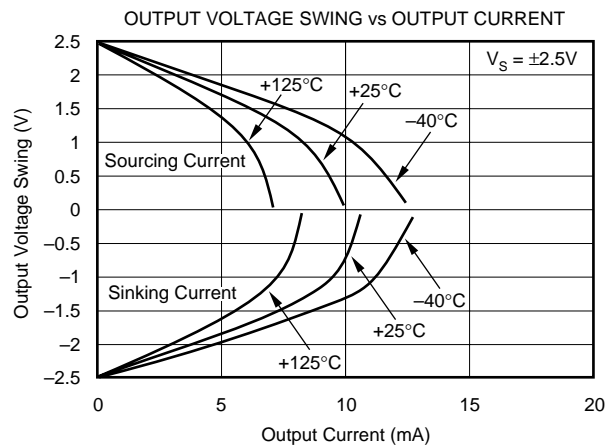
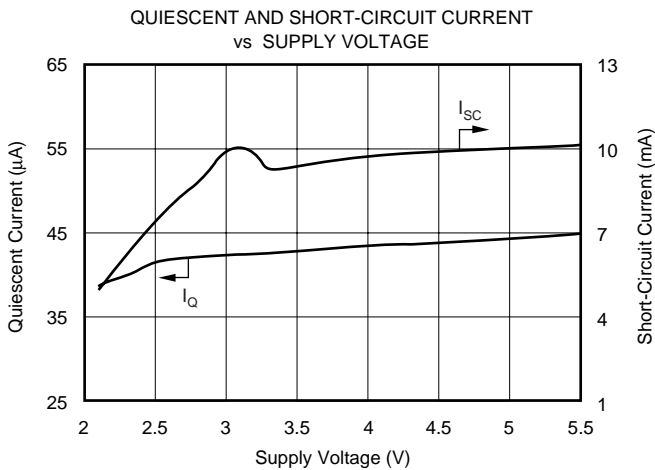
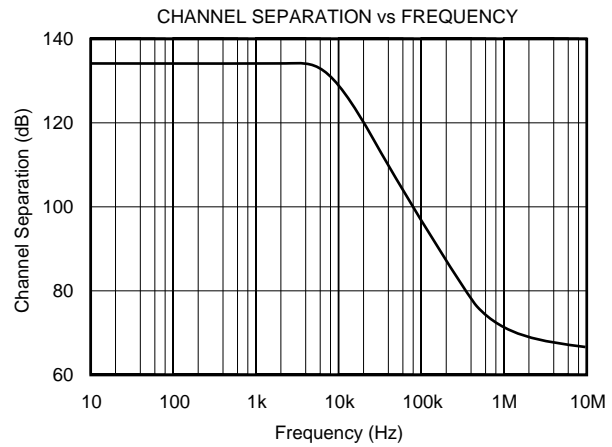
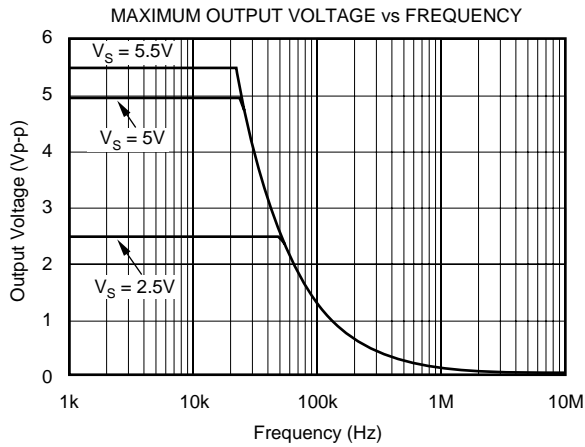
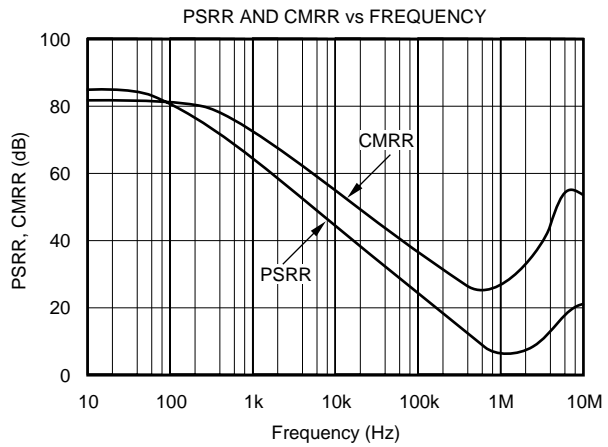
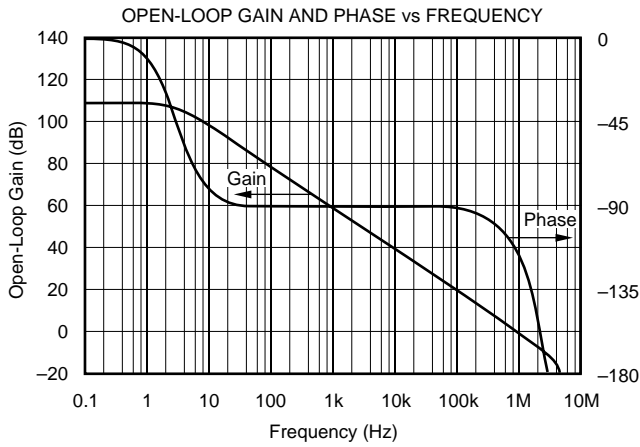

TYPICAL CHARACTERISTICS (Cont.)

At $T_A = +25^\circ\text{C}$, $R_L = 100\text{k}\Omega$ connected to $V_S/2$ and $V_{OUT} = V_S/2$, unless otherwise noted.

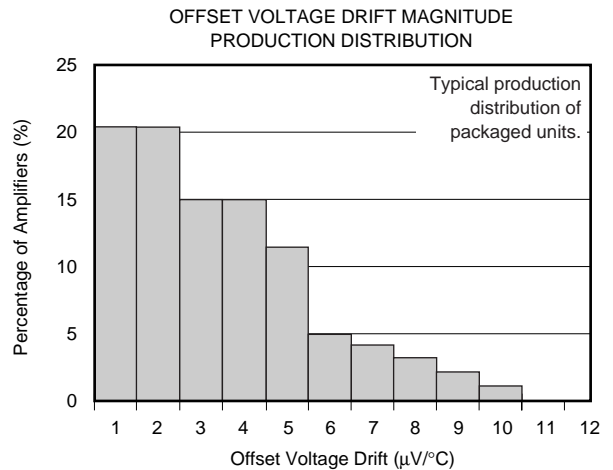
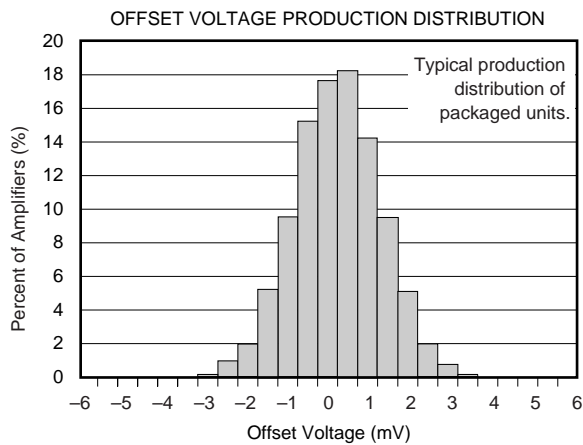
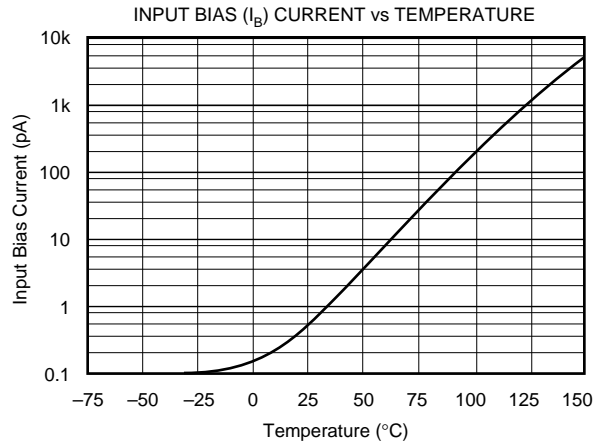
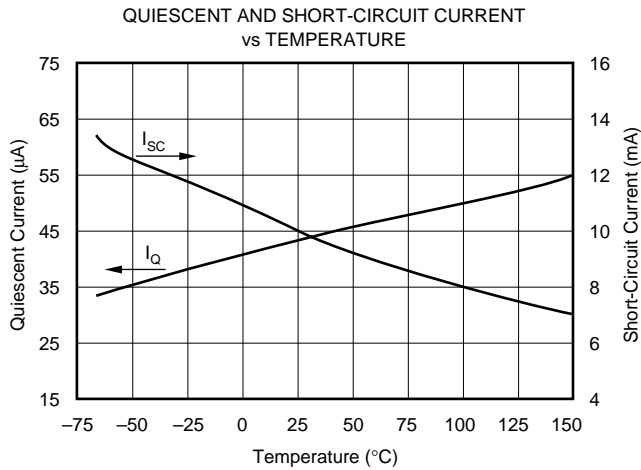
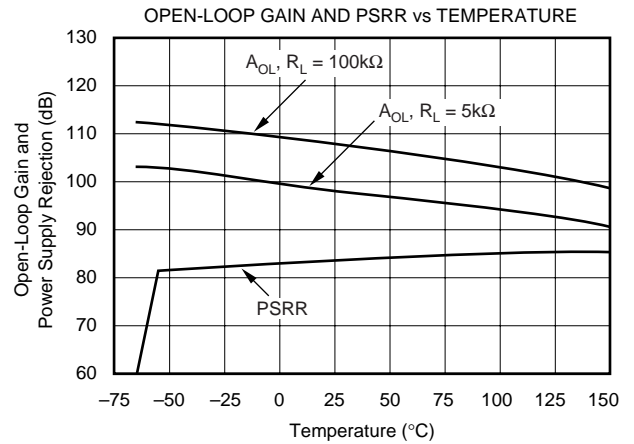
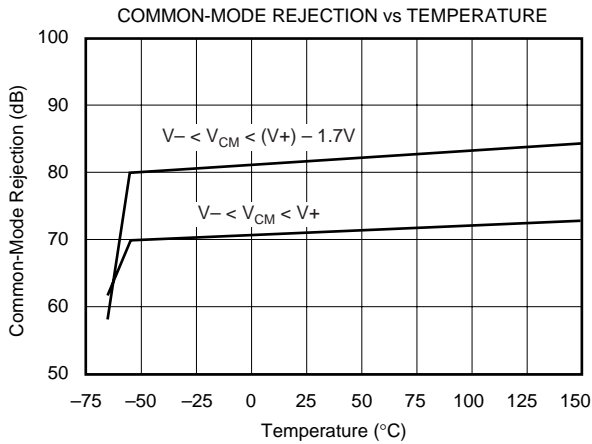

TYPICAL CHARACTERISTICS (Cont.)

At $T_A = +25^\circ\text{C}$, $R_L = 100\text{k}\Omega$ connected to $V_S/2$ and $V_{OUT} = V_S/2$, unless otherwise noted.

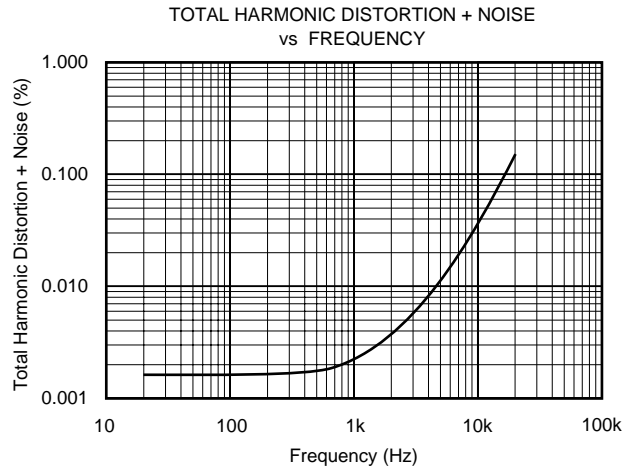
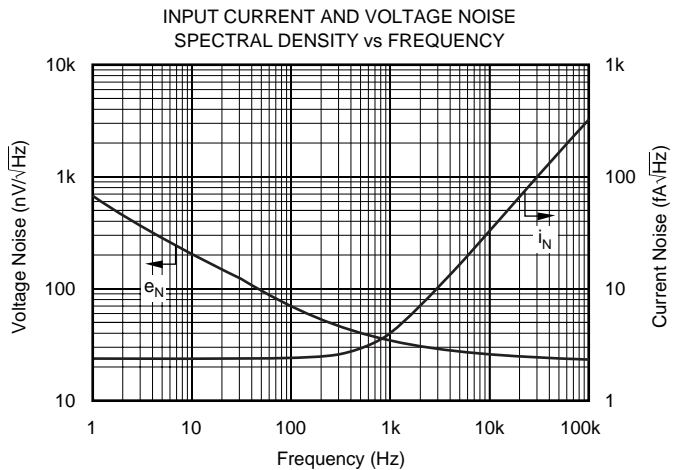
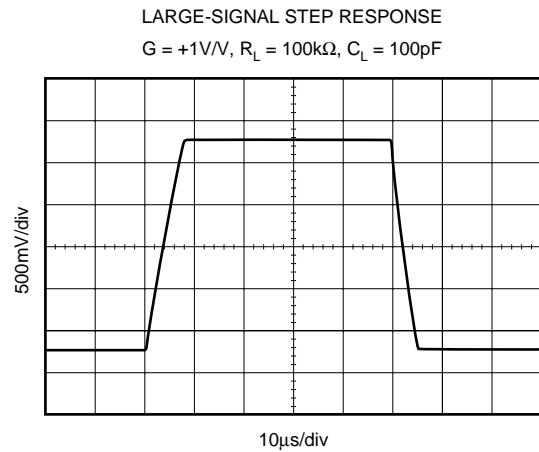
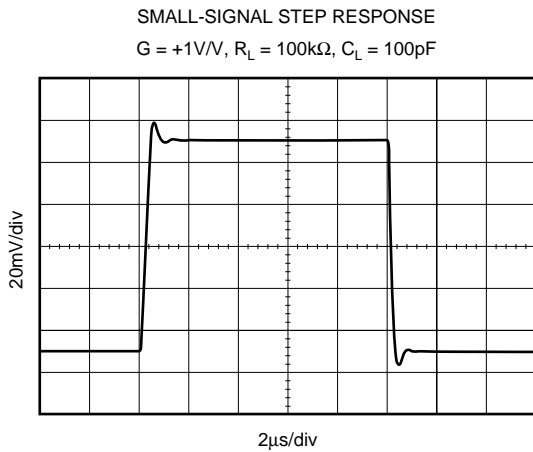
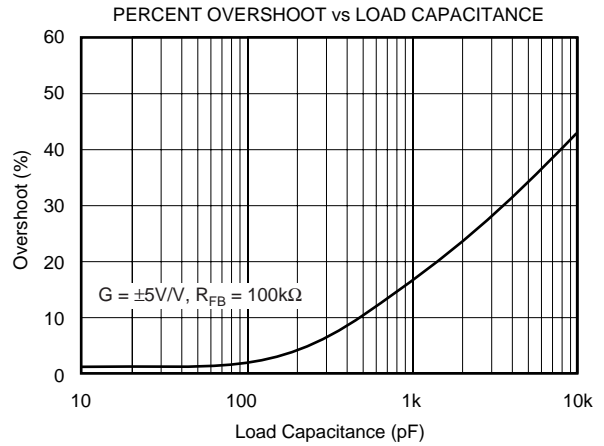
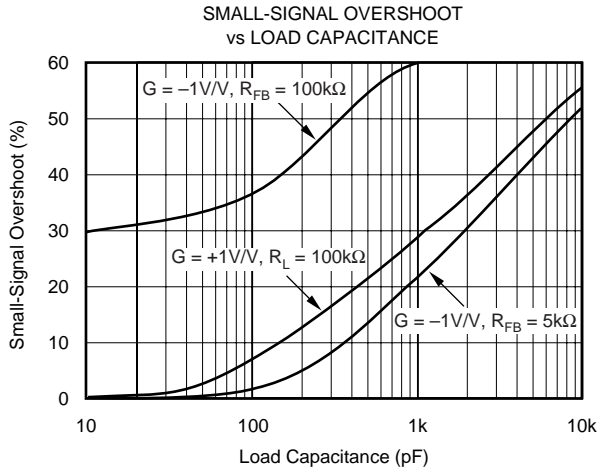

APPLICATIONS INFORMATION

OPA348 series op amps are unity-gain stable and suitable for a wide range of general-purpose applications.

The OPA348 series features wide bandwidth and unity-gain stability with rail-to-rail input and output for increased dynamic range. Figure 1 shows the input and output waveforms for the OPA348 in unity-gain configuration. Operation is from a single +5V supply with a 100kΩ load connected to $V_S/2$. The input is a 5Vp-p sinusoid. Output voltage is approximately 4.98Vp-p.

Power-supply pins should be bypassed with 0.01μF ceramic capacitors.

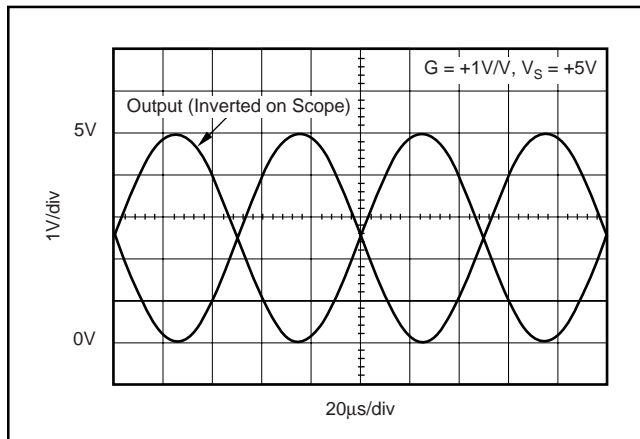

FIGURE 1. The OPA348 Features Rail-to-Rail Input/Output.

OPERATING VOLTAGE

OPA348 series op amps are fully specified and tested from +2.5V to +5.5V. However, supply voltage may range from +2.1V to +5.5V. Parameters are tested over the specified supply range—a unique feature of the OPA348 series. In addition, all temperature specifications apply from -40°C to $+125^{\circ}\text{C}$. Most behavior remains virtually unchanged throughout the full operating voltage range. Parameters that vary significantly with operating voltages or temperature are shown in the Typical Characteristics.

COMMON-MODE VOLTAGE RANGE

The input common-mode voltage range of the OPA348 series extends 200mV beyond the supply rails. This is achieved with a complementary input stage—an N-channel input differential pair in parallel with a P-channel differential pair. The N-channel pair is active for input voltages close to the positive rail, typically $(V+) - 1.2\text{V}$ to 300mV above the positive supply, while the P-channel pair is on for inputs from 300mV below the negative supply to approximately $(V+) - 1.4\text{V}$. There is a small transition region, typically $(V+) - 1.4\text{V}$ to $(V+) - 1.2\text{V}$, in which both pairs are on. This 200mV transition region, shown in Figure 2, can vary $\pm 300\text{mV}$ with process variation. Thus, the transition region (both stages on) can range from $(V+) - 1.7\text{V}$ to $(V+) - 1.5\text{V}$ on the low end, up to $(V+) - 1.1\text{V}$ to $(V+) - 0.9\text{V}$

on the high end. Within the 200mV transition region PSRR, CMRR, offset voltage, offset drift, and THD may be degraded compared to operation outside this region.

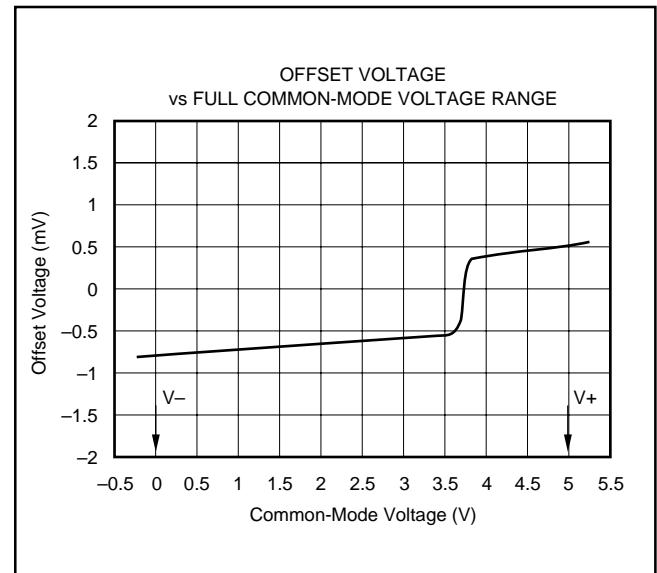

FIGURE 2. Behavior of Typical Transition Region at Room Temperature.

RAIL-TO-RAIL INPUT

The input common-mode range extends from $(V-) - 0.2\text{V}$ to $(V+) + 0.2\text{V}$. For normal operation, inputs should be limited to this range. The absolute maximum input voltage is 500mV beyond the supplies. Inputs greater than the input common-mode range but less than the maximum input voltage, while not valid, will not cause any damage to the op amp. Unlike some other op amps, if input current is limited the inputs may go beyond the power supplies without phase inversion, as shown in Figure 3.

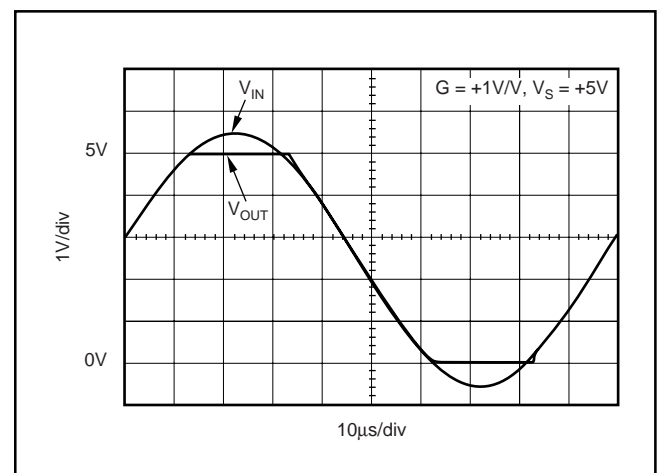

FIGURE 3. OPA348—No Phase Inversion with Inputs Greater than the Power-Supply Voltage.

Normally, input currents are 0.5pA. However, large inputs (greater than 500mV beyond the supply rails) can cause excessive current to flow in or out of the input pins. Therefore, as well as keeping the input voltage below the maximum rating, it is also important to limit the input current to less than 10mA. This is easily accomplished with an input voltage resistor, as shown in Figure 4.

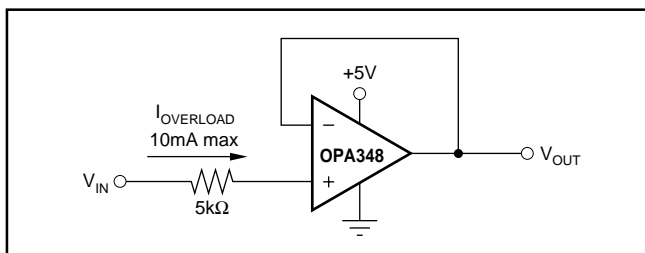

FIGURE 4. Input Current Protection for Voltages Exceeding the Supply Voltage.

RAIL-TO-RAIL OUTPUT

A class AB output stage with common-source transistors is used to achieve rail-to-rail output. This output stage is capable of driving 5kΩ loads connected to any potential between V+ and ground. For light resistive loads (> 100kΩ), the output voltage can typically swing to within 18mV from supply rail. With moderate resistive loads (10kΩ to 50kΩ), the output voltage can typically swing to within 100mV of the supply rails while maintaining high open-loop gain (see the typical characteristic “Output Voltage Swing vs Output Current”).

CAPACITIVE LOAD AND STABILITY

The OPA348 in a unity-gain configuration can directly drive up to 250pF pure capacitive load. Increasing the gain enhances the amplifier’s ability to drive greater capacitive loads (see the typical characteristic “Small-Signal Overshoot vs Capacitive Load”). In unity-gain configurations, capacitive load drive can be improved by inserting a small (10Ω to 20Ω) resistor, R_S , in series with the output, as shown in Figure 5. This significantly reduces ringing while maintaining DC performance for purely capacitive loads. However, if there is a resistive load in parallel with the capacitive load, a voltage divider is created, introducing a Direct Current (DC) error at the output and slightly reducing the output swing. The error introduced is proportional to the ratio R_S/R_L , and is generally negligible.

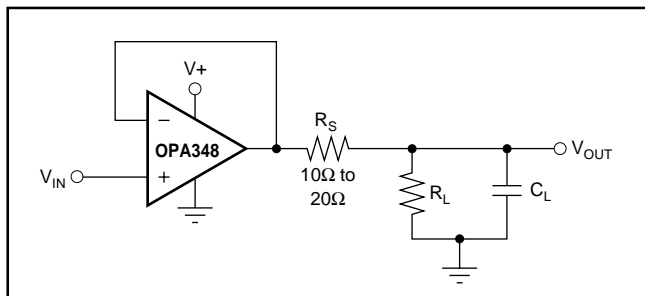

FIGURE 5. Series Resistor in Unity-Gain Buffer Configuration Improves Capacitive Load Drive.

In unity-gain inverter configuration, phase margin can be reduced by the reaction between the capacitance at the op amp input, and the gain setting resistors, thus degrading capacitive load drive. Best performance is achieved by using small valued resistors. For example, when driving a 500pF load, reducing the resistor values from 100kΩ to 5kΩ decreases overshoot from 55% to 13% (see the typical characteristic “Small-Signal Overshoot vs. Load Capacitance”). However, when large valued resistors cannot be avoided, a small (4pF to 6pF) capacitor, C_{FB} , can be inserted in the feedback, as shown in Figure 6. This significantly reduces overshoot by compensating the effect of capacitance, C_{IN} , which includes the amplifier’s input capacitance and PC board parasitic capacitance.

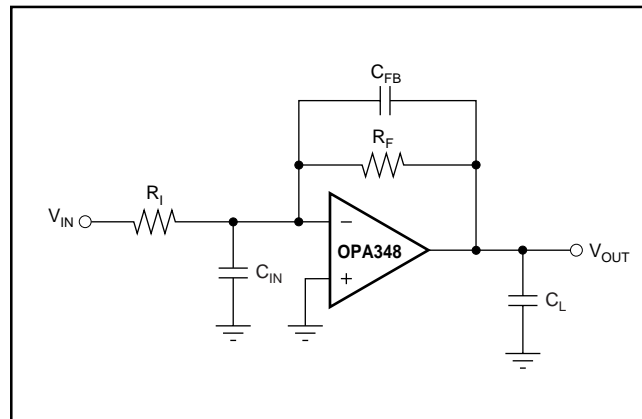

FIGURE 6. Improving Capacitive Load Drive.

DRIVING A/D CONVERTERS

The OPA348 series op amps are optimized for driving medium-speed sampling Analog-to-Digital Converters (ADCs). The OPA348 op amps buffer the ADCs input capacitance and resulting charge injection while providing signal gain.

The OPA348 in a basic noninverting configuration driving the ADS7822, see Figure 7. The ADS7822 is a 12-bit, *microPOWER* sampling converter in the MSOP-8 package. When used with the low-power, miniature packages of the OPA348, the combination is ideal for space-limited, low-power applications. In this configuration, an RC network at the ADC’s input can be used to provide for anti-aliasing filter and charge injection current.

The OPA348 in noninverting configuration driving ADS7822 limited, low-power applications. In this configuration, an RC network at the ADC’s input can be used to provide for anti-aliasing filter and charge injection current. See Figure 8 for the OPA2348 driving an ADS7822 in a speech bandpass filtered data acquisition system. This small, low-cost solution provides the necessary amplification and signal conditioning to interface directly with an electret microphone. This circuit will operate with $V_S = 2.7V$ to 5V with less than 250μA typical quiescent current.

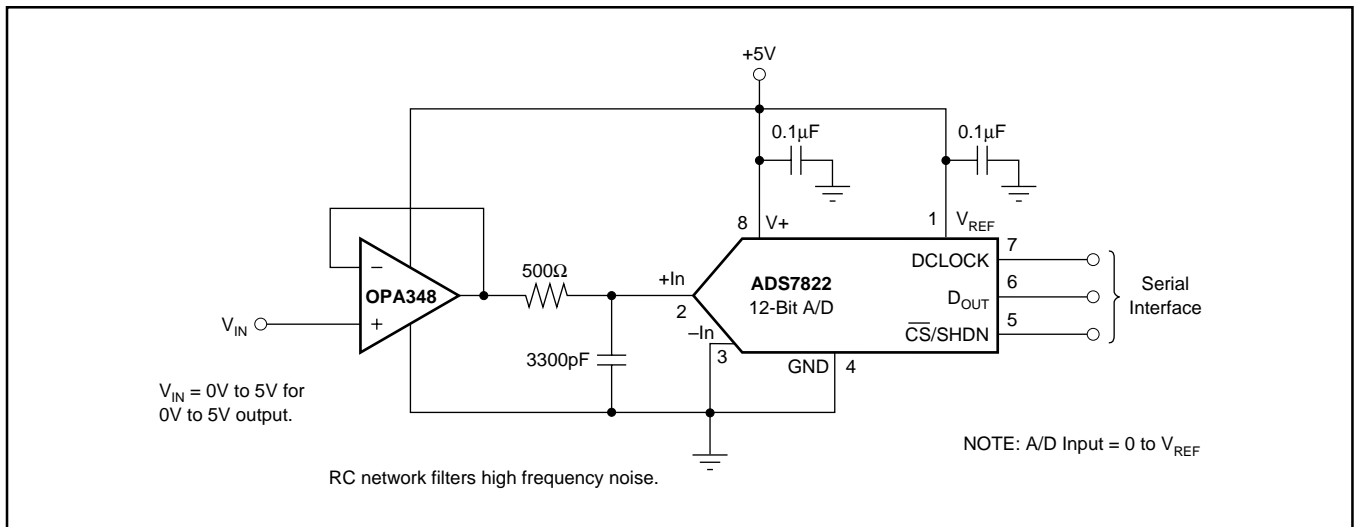

FIGURE 7. OPA348 in Noninverting Configuration Driving ADS7822.

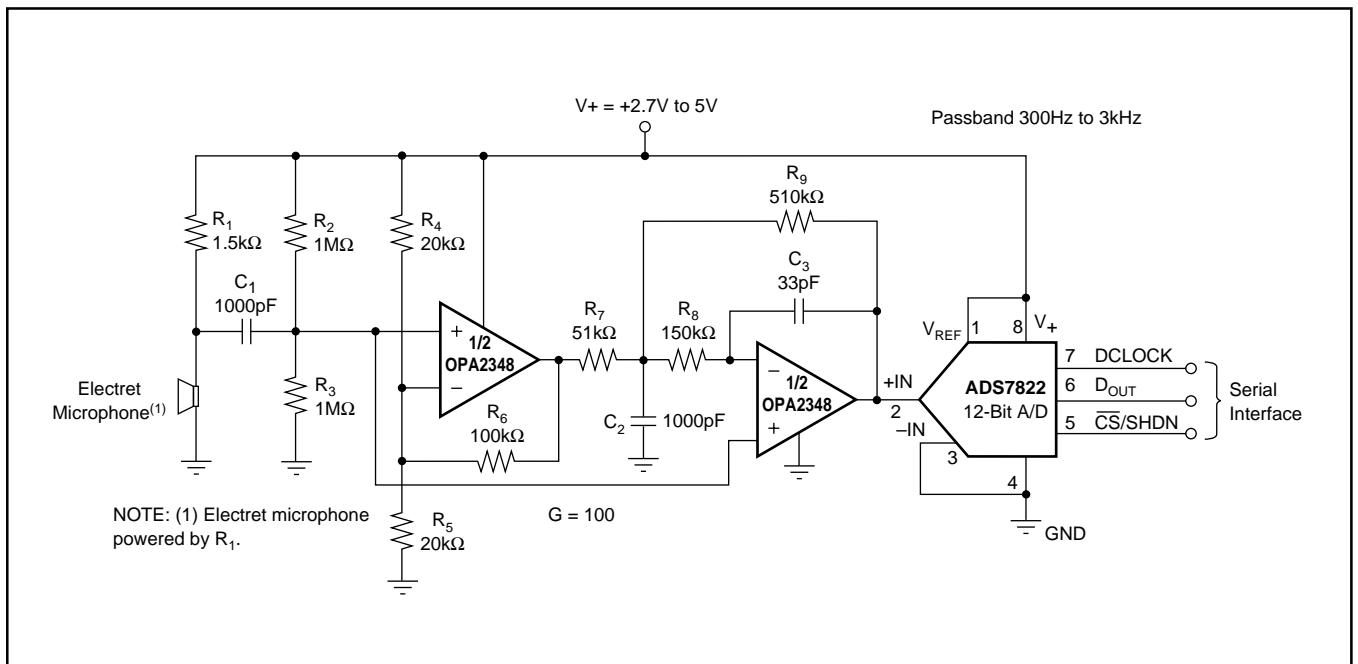
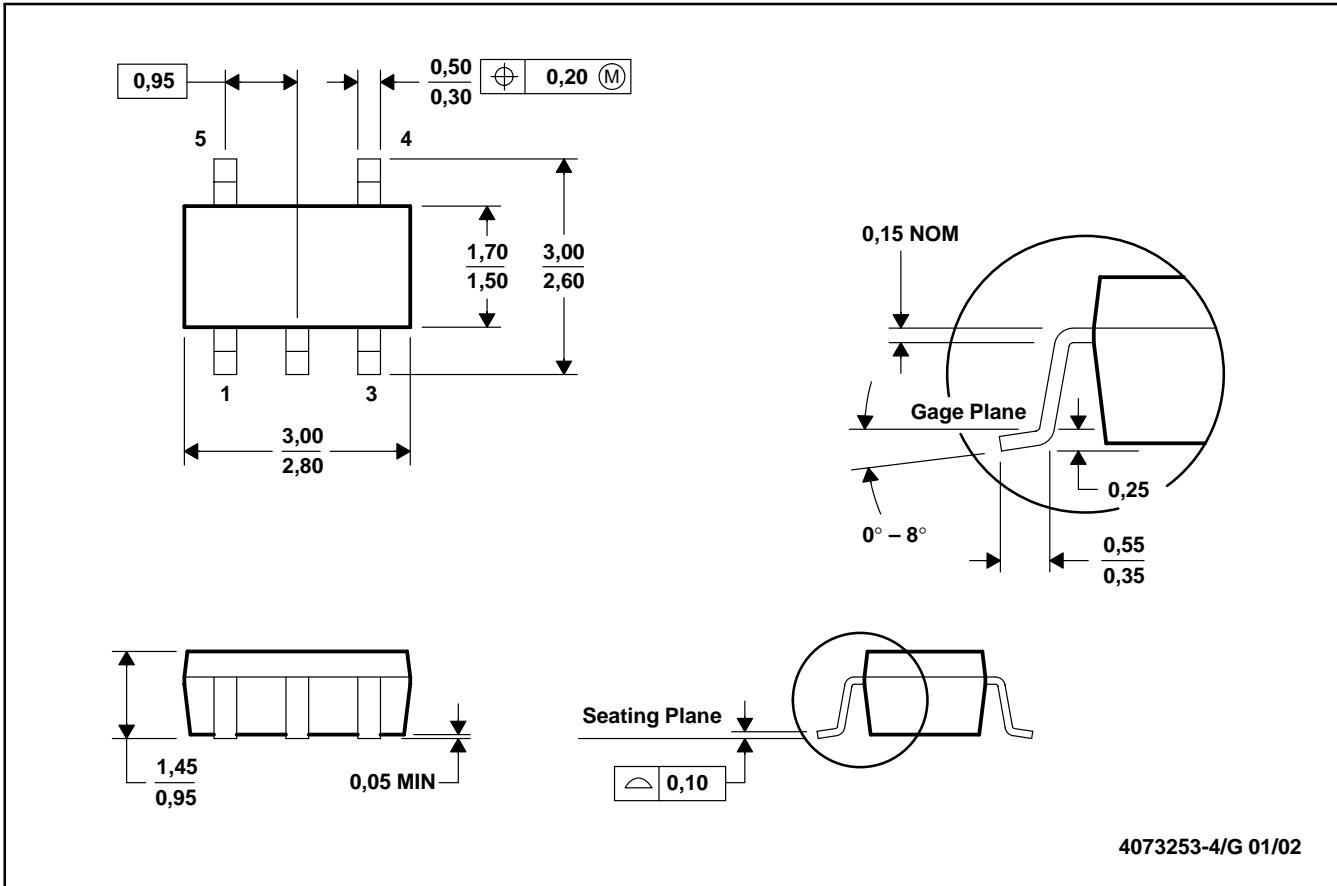

FIGURE 8. OPA2348 as a Speech Bandpass Filtered Data Acquisition System.

DBV (R-PDSO-G5)

PLASTIC SMALL-OUTLINE



- NOTES:
- A. All linear dimensions are in millimeters.
 - B. This drawing is subject to change without notice.
 - C. Body dimensions do not include mold flash or protrusion.
 - D. Falls within JEDEC MO-178

D (R-PDSO-G**)

PLASTIC SMALL-OUTLINE PACKAGE

8 PINS SHOWN

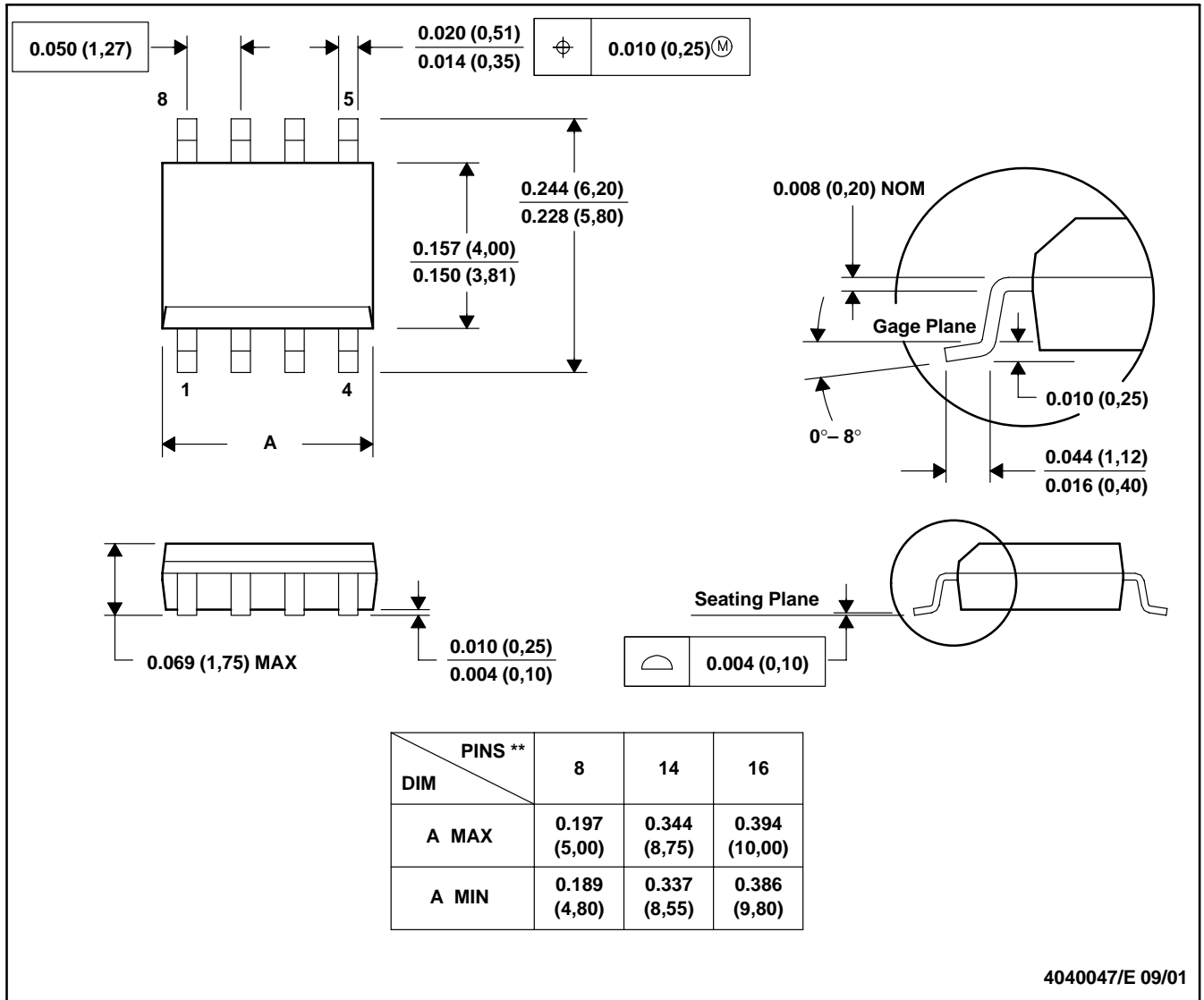

- NOTES: A. All linear dimensions are in inches (millimeters).
 B. This drawing is subject to change without notice.
 C. Body dimensions do not include mold flash or protrusion, not to exceed 0.006 (0,15).
 D. Falls within JEDEC MS-012

DCK (R-PDSO-G5)

PLASTIC SMALL-OUTLINE

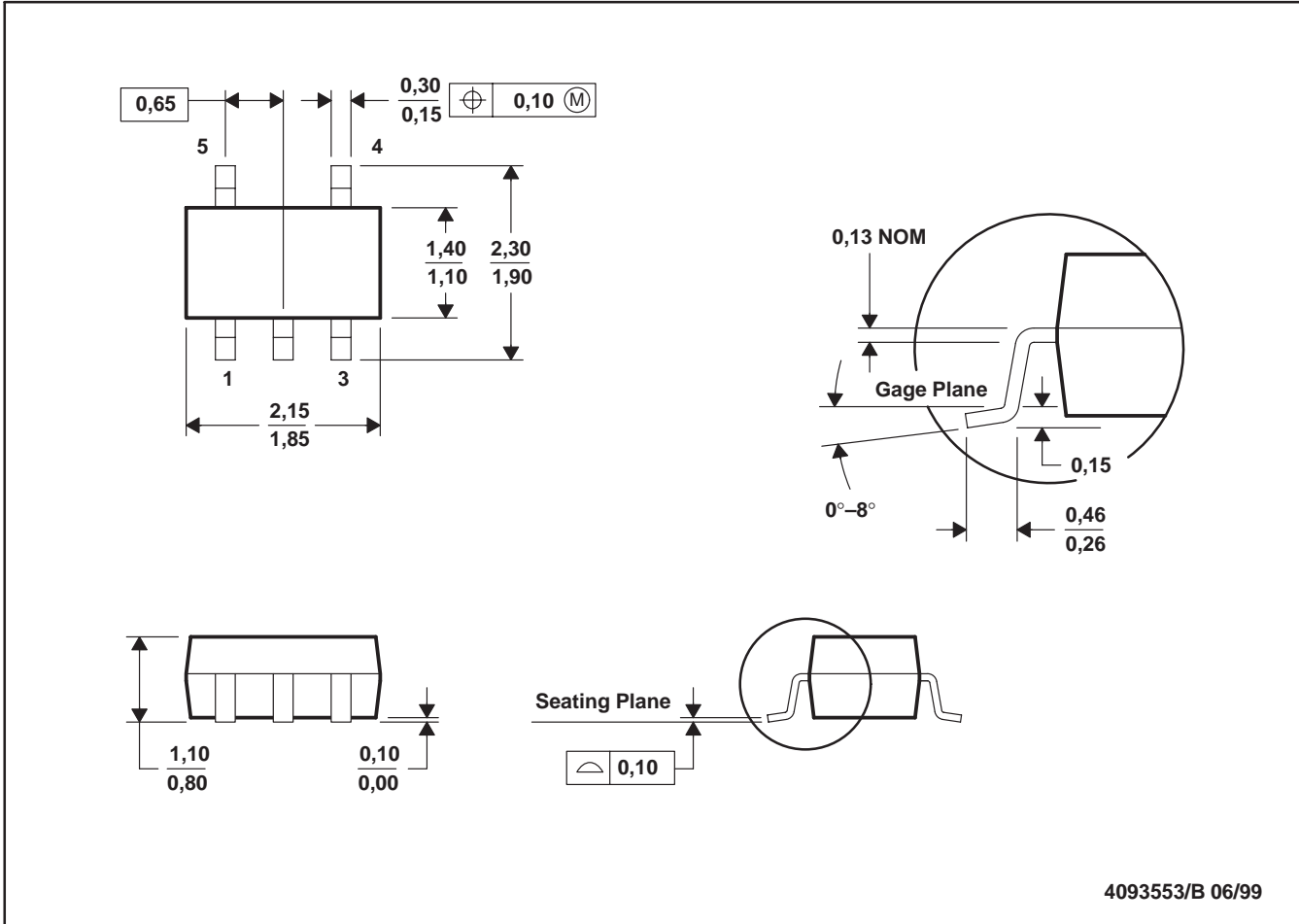

- NOTES: A. All linear dimensions are in millimeters.
 B. This drawing is subject to change without notice.
 C. Body dimensions do not include mold flash or protrusion.
 D. Falls within JEDEC MO-203

DCN (R-PDSO-G8)

PLASTIC SMALL-OUTLINE

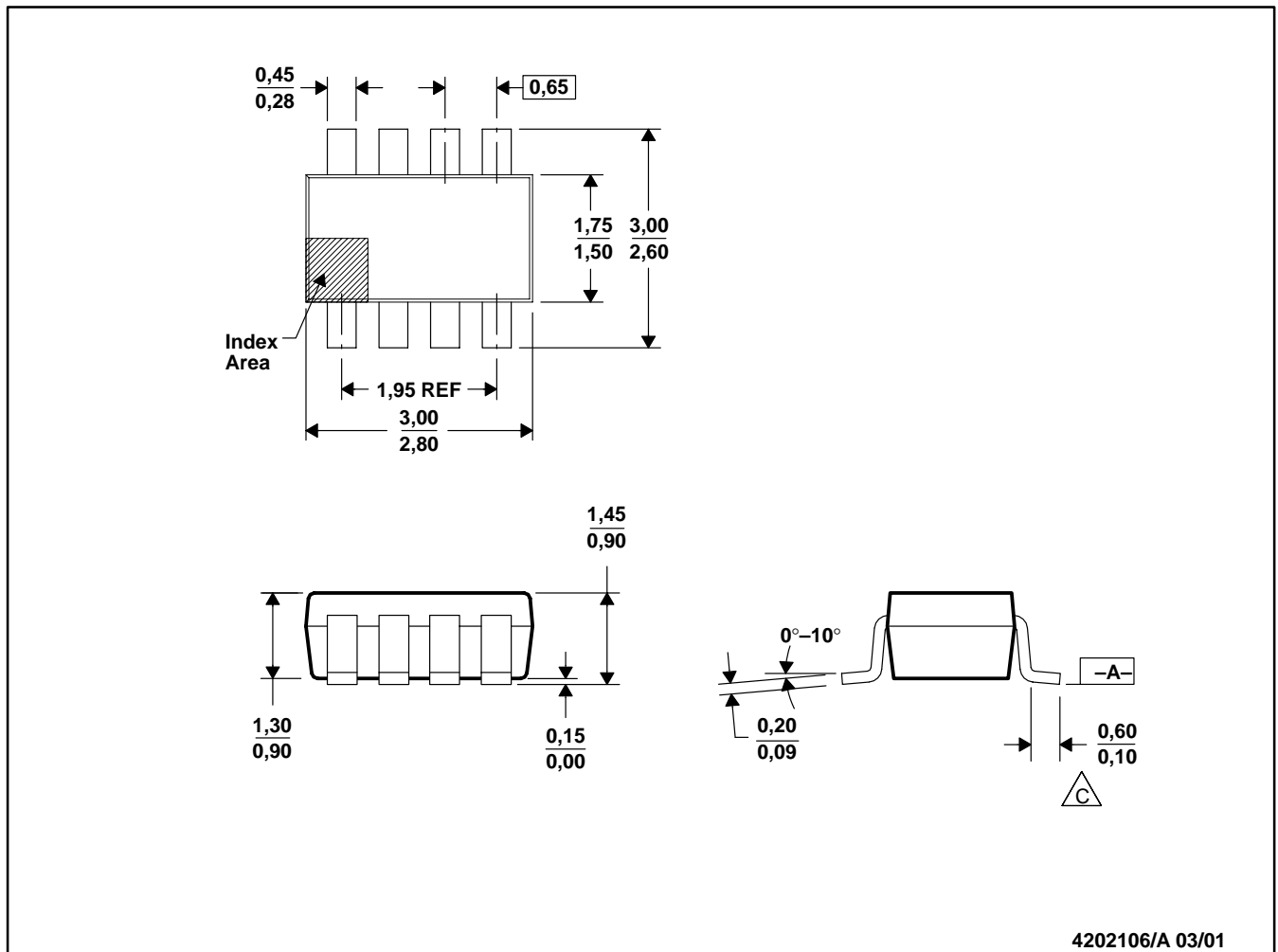

- NOTES: A. All linear dimensions are in millimeters.
 B. This drawing is subject to change without notice.
 C. Foot length measured reference to flat foot surface parallel to Datum A.
 D. Package outline exclusive of mold flash, metal burr and dambar protrusion/intrusion.
 E. Package outline inclusive of solder plating.
 F. A visual index feature must be located within the cross-hatched area.

PW (R-PDSO-G**)

PLASTIC SMALL-OUTLINE PACKAGE

14 PINS SHOWN

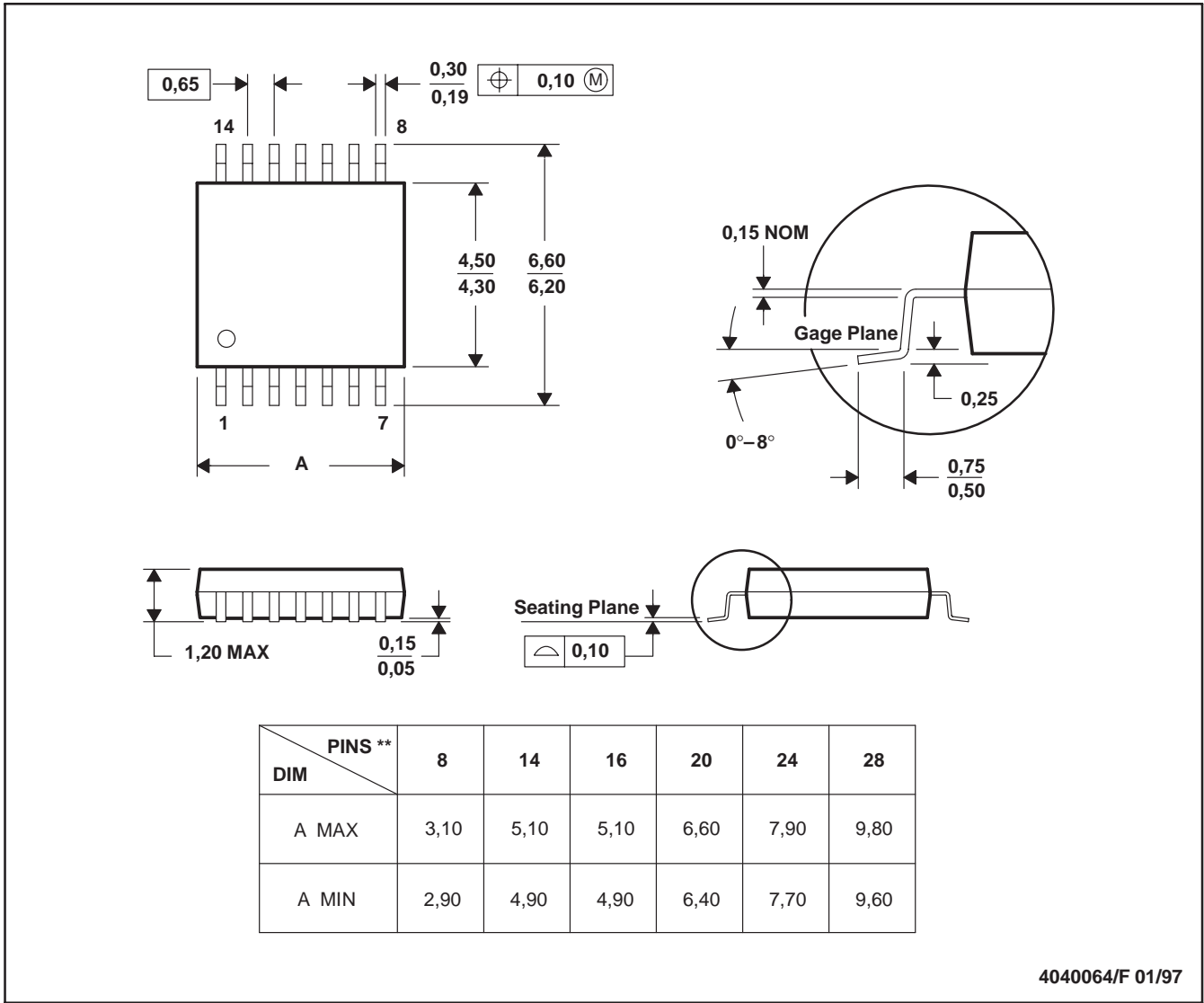

4040064/F 01/97

- NOTES: A. All linear dimensions are in millimeters.
 B. This drawing is subject to change without notice.
 C. Body dimensions do not include mold flash or protrusion not to exceed 0,15.
 D. Falls within JEDEC MO-153

PACKAGING INFORMATION

ORDERABLE DEVICE	STATUS(1)	PACKAGE TYPE	PACKAGE DRAWING	PINS	PACKAGE QTY
OPA2348AID	ACTIVE	SOIC	D	8	100
OPA2348AIDCNR	ACTIVE	SSOP	DCN	8	3000
OPA2348AIDCNT	ACTIVE	SSOP	DCN	8	250
OPA2348AIDR	ACTIVE	SOIC	D	8	2500
OPA348AID	ACTIVE	SOIC	D	8	100
OPA348AIDBVR	ACTIVE	SOP	DBV	5	3000
OPA348AIDBVT	ACTIVE	SOP	DBV	5	250
OPA348AIDCKR	ACTIVE	SOP	DCK	5	3000
OPA348AIDCKT	ACTIVE	SOP	DCK	5	250
OPA348AIDR	ACTIVE	SOIC	D	8	2500
OPA4348AID	ACTIVE	SOIC	D	14	58
OPA4348AIDR	ACTIVE	SOIC	D	14	2500
OPA4348AIPWR	ACTIVE	TSSOP	PW	14	2500
OPA4348AIPWT	ACTIVE	TSSOP	PW	14	250

(1) The marketing status values are defined as follows:

ACTIVE: Product device recommended for new designs.

LIFEBUY: TI has announced that the device will be discontinued, and a lifetime-buy period is in effect.

NRND: Not recommended for new designs. Device is in production to support existing customers, but TI does not recommend using this part in a new design.

PREVIEW: Device has been announced but is not in production. Samples may or may not be available.

OBSOLETE: TI has discontinued the production of the device.

IMPORTANT NOTICE

Texas Instruments Incorporated and its subsidiaries (TI) reserve the right to make corrections, modifications, enhancements, improvements, and other changes to its products and services at any time and to discontinue any product or service without notice. Customers should obtain the latest relevant information before placing orders and should verify that such information is current and complete. All products are sold subject to TI's terms and conditions of sale supplied at the time of order acknowledgment.

TI warrants performance of its hardware products to the specifications applicable at the time of sale in accordance with TI's standard warranty. Testing and other quality control techniques are used to the extent TI deems necessary to support this warranty. Except where mandated by government requirements, testing of all parameters of each product is not necessarily performed.

TI assumes no liability for applications assistance or customer product design. Customers are responsible for their products and applications using TI components. To minimize the risks associated with customer products and applications, customers should provide adequate design and operating safeguards.

TI does not warrant or represent that any license, either express or implied, is granted under any TI patent right, copyright, mask work right, or other TI intellectual property right relating to any combination, machine, or process in which TI products or services are used. Information published by TI regarding third-party products or services does not constitute a license from TI to use such products or services or a warranty or endorsement thereof. Use of such information may require a license from a third party under the patents or other intellectual property of the third party, or a license from TI under the patents or other intellectual property of TI.

Reproduction of information in TI data books or data sheets is permissible only if reproduction is without alteration and is accompanied by all associated warranties, conditions, limitations, and notices. Reproduction of this information with alteration is an unfair and deceptive business practice. TI is not responsible or liable for such altered documentation.

Resale of TI products or services with statements different from or beyond the parameters stated by TI for that product or service voids all express and any implied warranties for the associated TI product or service and is an unfair and deceptive business practice. TI is not responsible or liable for any such statements.

Following are URLs where you can obtain information on other Texas Instruments products and application solutions:

Products		Applications	
Amplifiers	amplifier.ti.com	Audio	www.ti.com/audio
Data Converters	dataconverter.ti.com	Automotive	www.ti.com/automotive
DSP	dsp.ti.com	Broadband	www.ti.com/broadband
Interface	interface.ti.com	Digital Control	www.ti.com/digitalcontrol
Logic	logic.ti.com	Military	www.ti.com/military
Power Mgmt	power.ti.com	Optical Networking	www.ti.com/opticalnetwork
Microcontrollers	microcontroller.ti.com	Security	www.ti.com/security
		Telephony	www.ti.com/telephony
		Video & Imaging	www.ti.com/video
		Wireless	www.ti.com/wireless

Mailing Address: Texas Instruments
Post Office Box 655303 Dallas, Texas 75265

Copyright © 2003, Texas Instruments Incorporated