

DATA SHEET

For a complete data sheet, please also download:

- The IC06 74HC/HCT/HCU/HCMOS Logic Family Specifications
- The IC06 74HC/HCT/HCU/HCMOS Logic Package Information
- The IC06 74HC/HCT/HCU/HCMOS Logic Package Outlines

74HC/HCT14 Hex inverting Schmitt trigger

Product specification
File under Integrated Circuits, IC06

September 1993

Hex inverting Schmitt trigger

74HC/HCT14

FEATURES

- Output capability: standard
- I_{CC} category: SSI

GENERAL DESCRIPTION

The 74HC/HCT14 are high-speed Si-gate CMOS devices and are pin compatible with low power Schottky TTL (LSTTL). They are specified in compliance with JEDEC standard no. 7A.

The 74HC/HCT14 provide six inverting buffers with Schmitt-trigger action. They are capable of transforming slowly changing input signals into sharply defined, jitter-free output signals.

QUICK REFERENCE DATA

GND = 0 V; $T_{amb} = 25\text{ }^{\circ}\text{C}$; $t_r = t_f = 6\text{ ns}$

SYMBOL	PARAMETER	CONDITIONS	TYPICAL		UNIT
			HC	HCT	
t_{PHL}/t_{PLH}	propagation delay nA to nY	$C_L = 15\text{ pF}$; $V_{CC} = 5\text{ V}$	12	17	ns
C_I	input capacitance		3.5	3.5	pF
C_{PD}	power dissipation capacitance per gate	notes 1 and 2	7	8	pF

Notes

1. C_{PD} is used to determine the dynamic power dissipation (P_D in μW):

$$P_D = C_{PD} \times V_{CC}^2 \times f_i + \sum (C_L \times V_{CC}^2 \times f_o) \text{ where:}$$

f_i = input frequency in MHz

f_o = output frequency in MHz

C_L = output load capacitance in pF

V_{CC} = supply voltage in V

$\sum (C_L \times V_{CC}^2 \times f_o)$ = sum of outputs

2. For HC the condition is $V_I = \text{GND to } V_{CC}$
For HCT the condition is $V_I = \text{GND to } V_{CC} - 1.5\text{ V}$

ORDERING INFORMATION

See "74HC/HCT/HCU/HCMOS Logic Package Information".

Hex inverting Schmitt trigger

74HC/HCT14

PIN DESCRIPTION

PIN NO.	SYMBOL	NAME AND FUNCTION
1, 3, 5, 9, 11, 13	1A to 6A	data inputs
2, 4, 6, 8, 10, 12	1Y to 6Y	data outputs
7	GND	ground (0 V)
14	V _{CC}	positive supply voltage

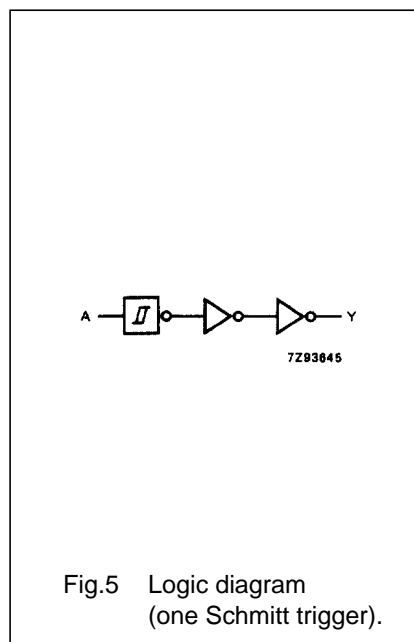
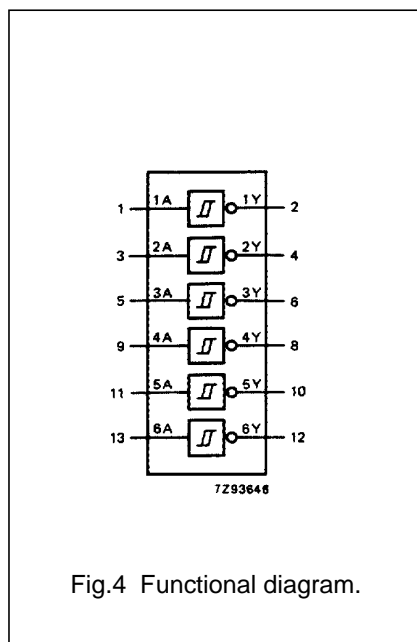
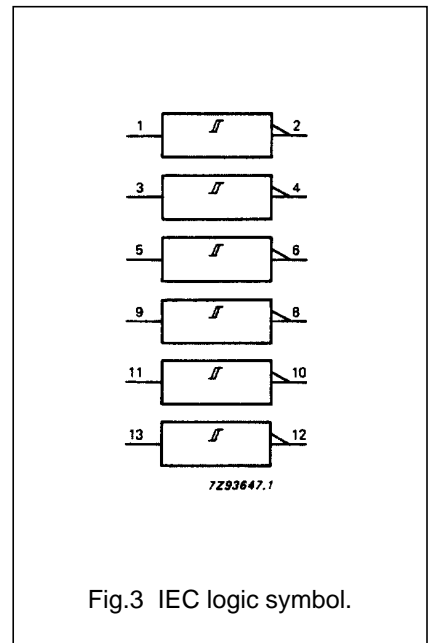
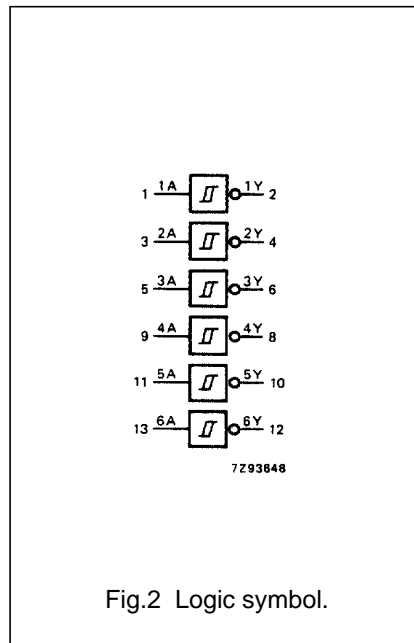
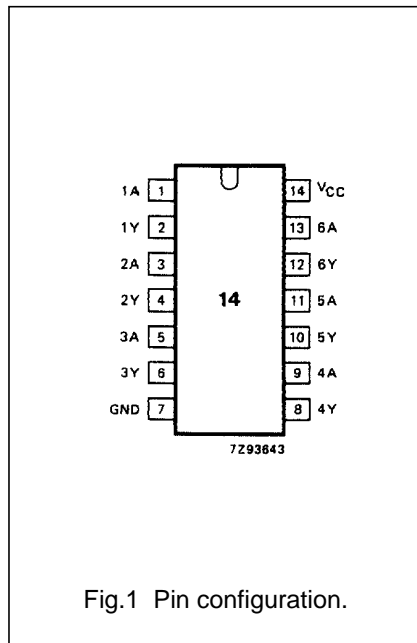

FUNCTION TABLE

INPUT	OUTPUT
nA	nY
L	H
H	L

Notes

1. H = HIGH voltage level
L = LOW voltage level

APPLICATIONS

- Wave and pulse shapers
- Astable multivibrators
- Monostable multivibrators

Hex inverting Schmitt trigger

74HC/HCT14

DC CHARACTERISTICS FOR 74HC

For the DC characteristics see *"74HC/HCT/HCU/HCMOS Logic Family Specifications"*. Transfer characteristics are given below.

Output capability: standard

I_{CC} category: SSI

Transfer characteristics for 74HC

Voltages are referenced to GND (ground = 0 V)

SYMBOL	PARAMETER	T _{amb} (°C)								UNIT	TEST CONDITIONS	
		74HC									V _{CC} (V)	WAVEFORMS
		+25			-40 to +85		-40 to +125					
		min.	typ.	max.	min.	max.	min.	max.				
V _{T+}	positive-going threshold	0.7 1.7 2.1	1.18 2.38 3.14	1.5 3.15 4.2	0.7 1.7 2.1	1.5 3.15 4.2	0.7 1.7 2.1	1.5 3.15 4.2	V	2.0 4.5 6.0	Figs 6 and 7	
V _{T-}	negative-going threshold	0.3 0.9 1.2	0.52 1.40 1.89	0.90 2.00 2.60	0.3 0.90 1.20	0.90 2.00 2.60	0.30 0.90 1.2	0.90 2.00 2.60	V	2.0 4.5 6.0	Figs 6 and 7	
V _H	hysteresis (V _{T+} - V _{T-})	0.2 0.4 0.6	0.66 0.98 1.25	1.0 1.4 1.6	0.2 0.4 0.6	1.0 1.4 1.6	0.2 0.4 0.6	1.0 1.4 1.6	V	2.0 4.5 6.0	Figs 6 and 7	

AC CHARACTERISTICS FOR 74HC

GND = 0 V; t_f = t_r = 6 ns; C_L = 50 pF

SYMBOL	PARAMETER	T _{amb} (°C)								UNIT	TEST CONDITIONS	
		74HC									V _{CC} (V)	WAVEFORMS
		+25			-40 to +85		-40 to +125					
		min.	typ.	max.	min.	max.	min.	max.				
t _{PHL} / t _{PLH}	propagation delay nA to nY		41 15 12	125 25 21		155 31 26		190 38 32	ns	2.0 4.5 6.0	Fig.8	
t _{THL} / t _{TLH}	output transition time		19 7 6	75 15 13		95 19 15		110 22 19	ns	2.0 4.5 6.0	Fig.8	

Hex inverting Schmitt trigger

74HC/HCT14

DC CHARACTERISTICS FOR 74HCT

For the DC characteristics see *"74HC/HCT/HCU/HCMOS Logic Family Specifications"*. Transfer characteristics are given below.

Output capability: standard

I_{CC} category: SSI

Note to HCT types

The value of additional quiescent supply current (ΔI_{CC}) for a unit load of 1 is given in the family specifications.

To determine ΔI_{CC} per input, multiply this value by the unit load coefficient shown in the table below.

INPUT	UNIT LOAD COEFFICIENT
nA	0.3

Transfer characteristics for 74HCT

Voltages are referenced to GND (ground = 0 V)

SYMBOL	PARAMETER	T_{amb} (°C)								UNIT	TEST CONDITIONS	
		74HCT									V_{CC} (V)	WAVEFORMS
		+25			-40 to +85		-40 to +125					
		min.	typ.	max.	min.	max.	min.	max.				
V_{T+}	positive-going threshold	1.2 1.4	1.41 1.59	1.9 2.1	1.2 1.4	1.9 2.1	1.2 1.4	1.9 2.1	V	4.5 5.5	Figs 6 and 7	
V_{T-}	negative-going threshold	0.5 0.6	0.85 0.99	1.2 1.4	0.5 0.6	1.2 1.4	0.5 0.6	1.2 1.4	V	4.5 5.5	Figs 6 and 7	
V_H	hysteresis ($V_{T+} - V_{T-}$)	0.4 0.4	0.56 0.60	– –	0.4 0.4	– –	0.4 0.4	– –	V	4.5 5.5	Figs 6 and 7	

AC CHARACTERISTICS FOR 74HCT

GND = 0 V; $t_r = t_f = 6$ ns; $C_L = 50$ pF

SYMBOL	PARAMETER	T_{amb} (°C)								UNIT	TEST CONDITIONS	
		74HCT									V_{CC} (V)	WAVEFORMS
		+25			-40 to +85		-40 to +125					
		min.	typ.	max.	min.	max.	min.	max.				
t_{PHL} / t_{PLH}	propagation delay nA, to nY		20	34		43		51	ns	4.5	Fig.8	
t_{THL} / t_{TLH}	output transition time		7	15		19		22	ns	4.5	Fig.8	

Hex inverting Schmitt trigger

74HC/HCT14

TRANSFER CHARACTERISTIC WAVEFORMS

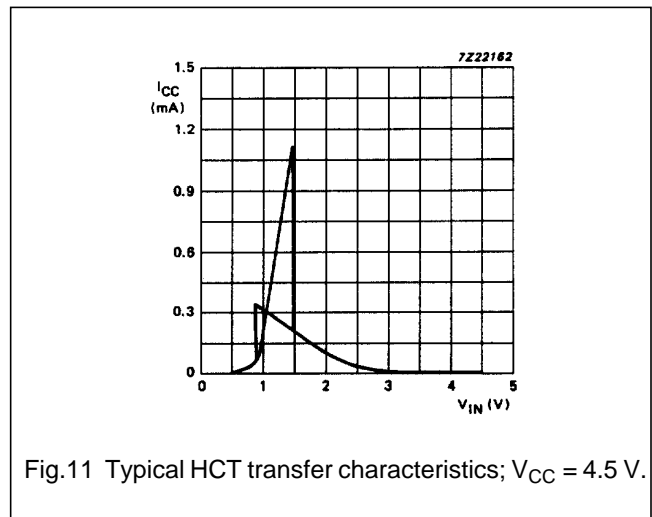
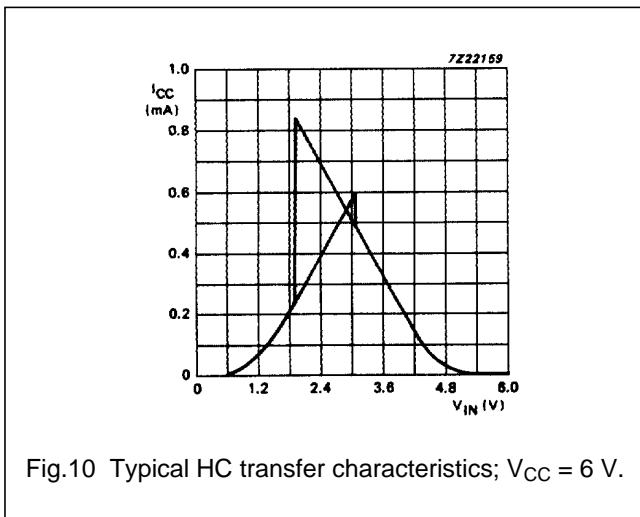
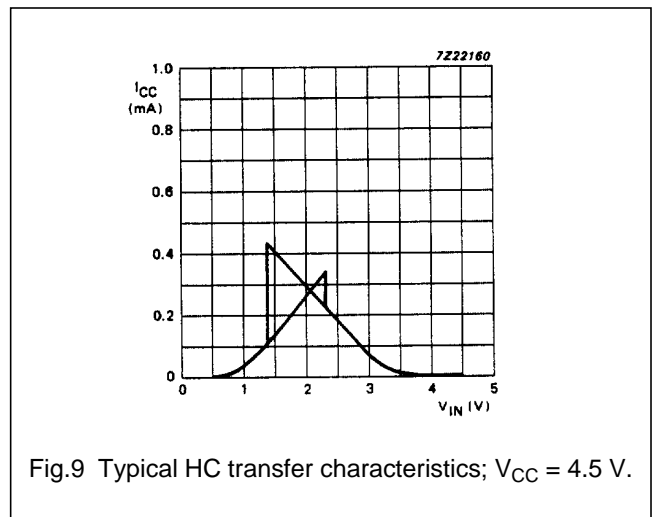
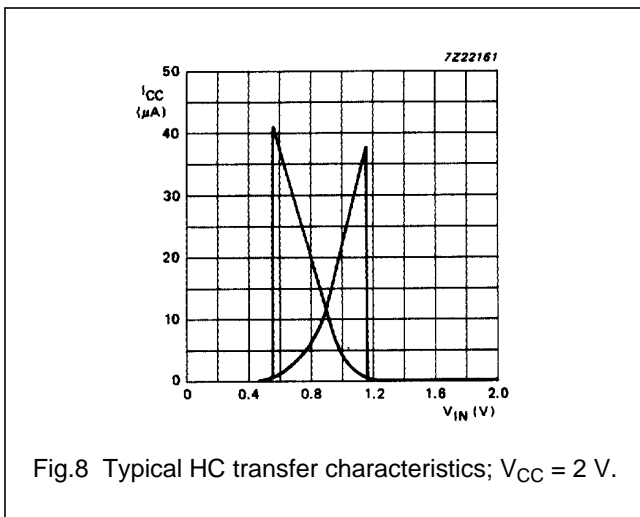
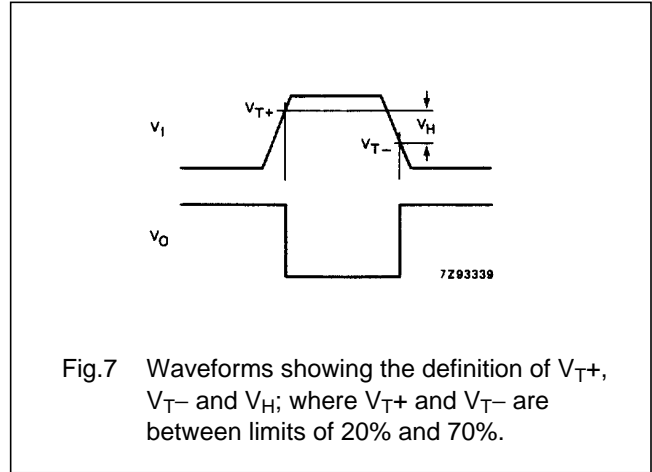
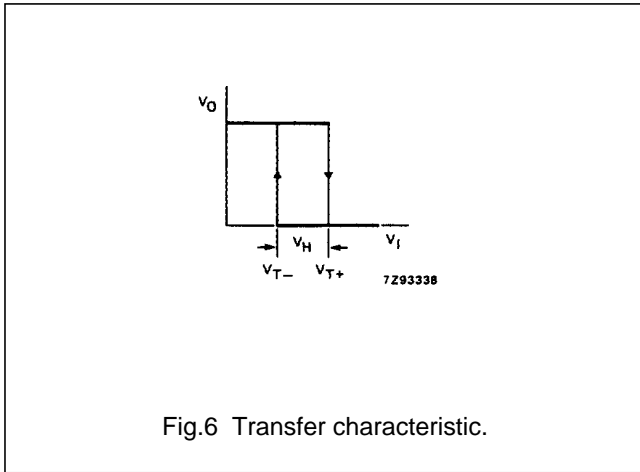

Hex inverting Schmitt trigger

74HC/HCT14

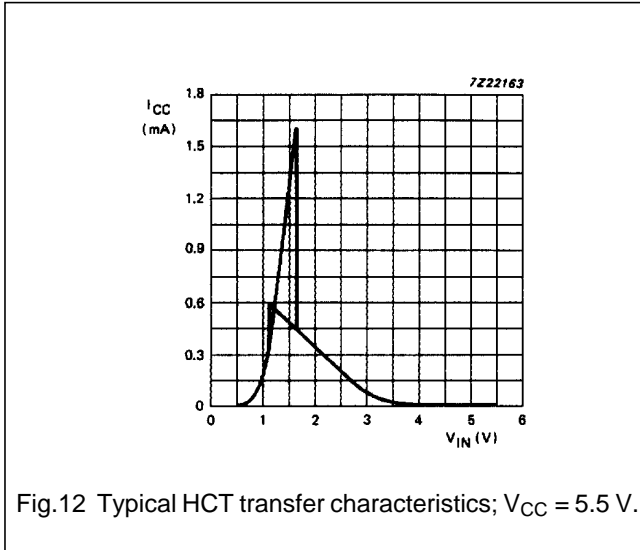
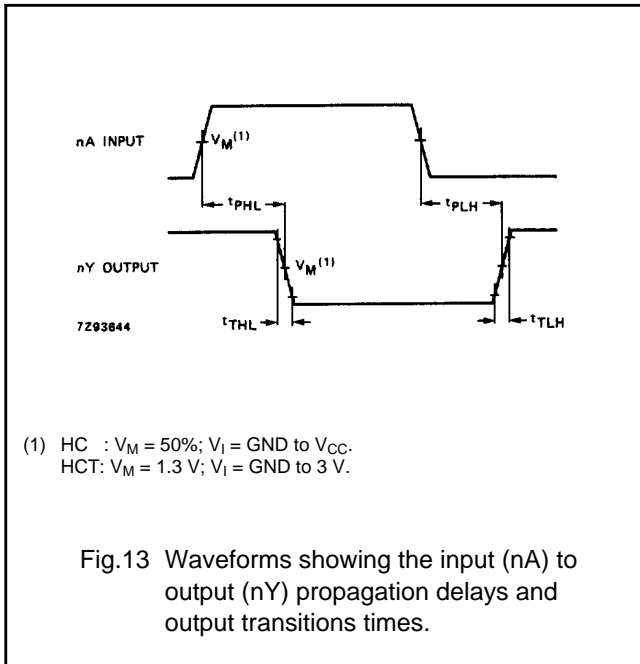

Fig.12 Typical HCT transfer characteristics; $V_{CC} = 5.5 \text{ V}$.

AC WAVEFORMS



Hex inverting Schmitt trigger

74HC/HCT14

APPLICATION INFORMATION

The slow input rise and fall times cause additional power dissipation, this can be calculated using the following formula:

$$P_{ad} = f_i \times (t_r \times I_{CCa} + t_f \times I_{CCa}) \times V_{CC}$$

Where:

- P_{ad} = additional power dissipation (μW)
- f_i = input frequency (MHz)
- t_r = input rise time (μs); 10% – 90%
- t_f = input fall time (μs); 10% – 90%
- I_{CCa} = average additional supply current (μA)

Average I_{CCa} differs with positive or negative input transitions, as shown in Figs 14 and 15.

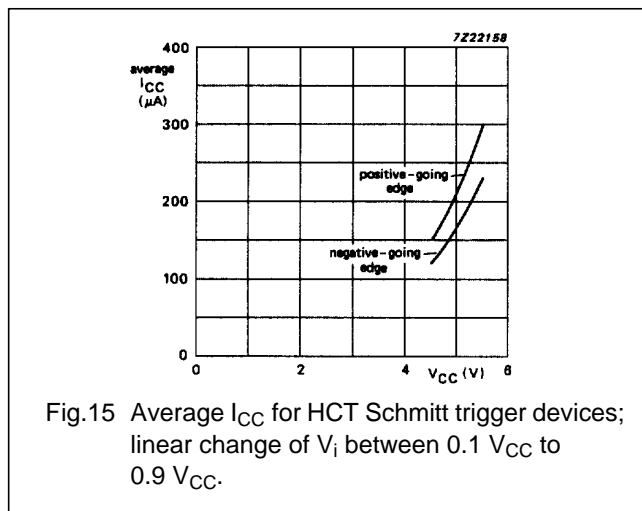
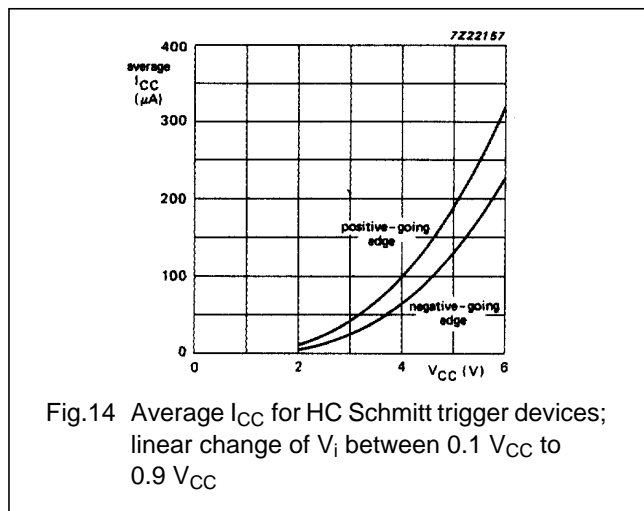

HC/HCT14 used in a relaxation oscillator circuit, see Fig.16.

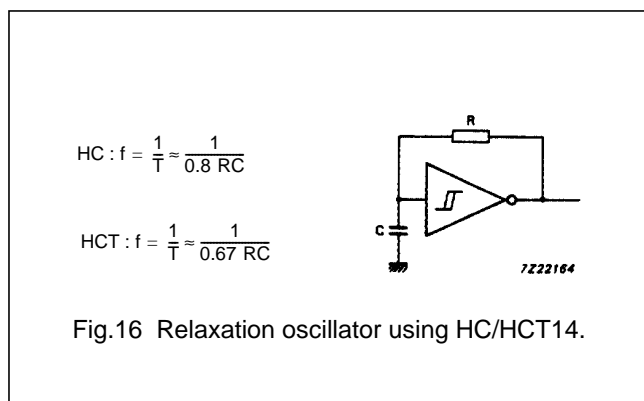

Note to Application information

All values given are typical unless otherwise specified.

PACKAGE OUTLINES

See *"74HC/HCT/HCU/HCMOS Logic Package Outlines"*.