

LOCATION OF CONTROLS - EMPLACEMENT DES REGLAGES - LAGEPLAN
EINSTELLER - POSIZIONE REGOLATORI DI SERVIZIO - SITUACIÓN DE LOS AJUSTES

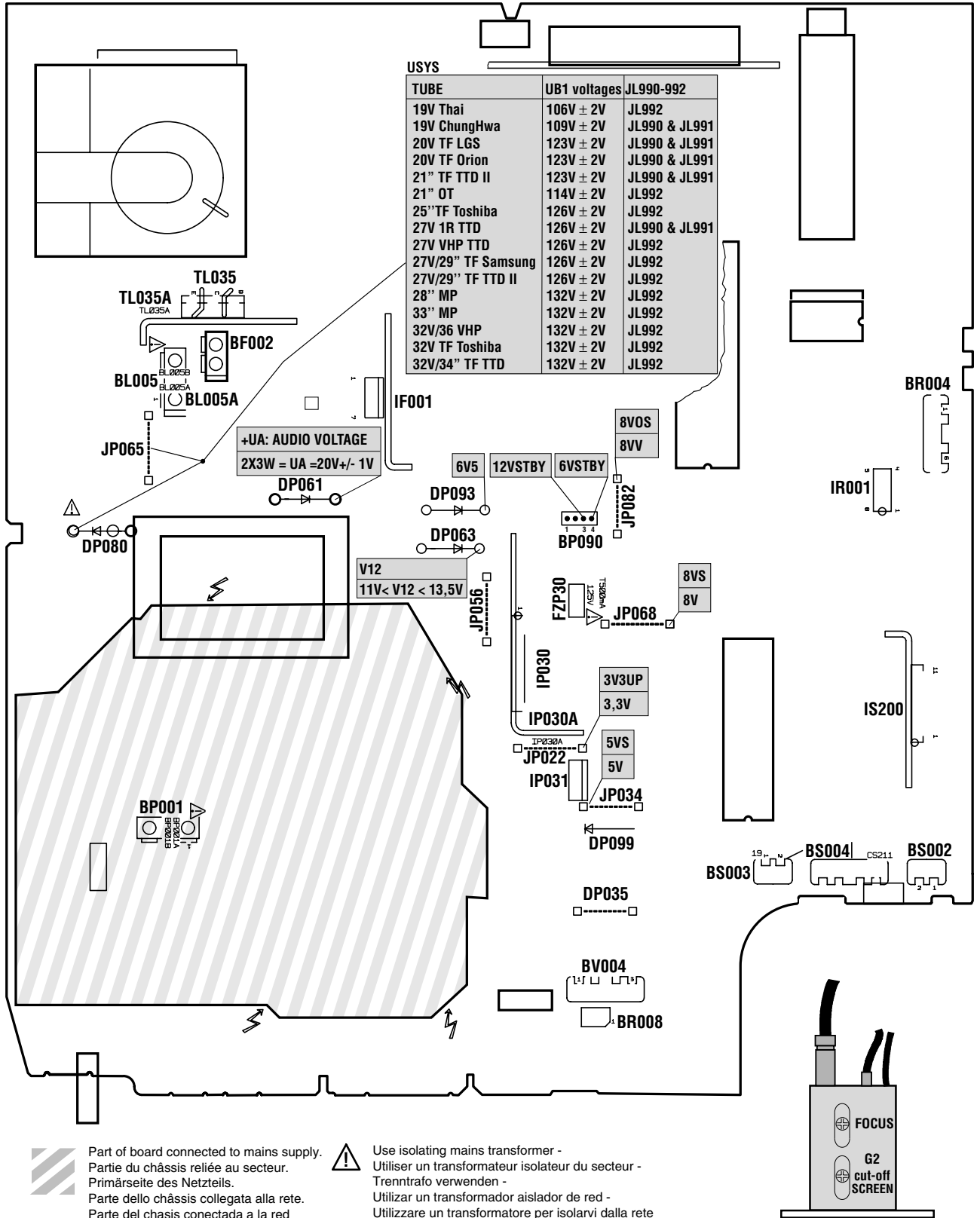

ADJUSTMENTS - REGLAGES - EINSTELLUNGEN - REGOLAZIONE - AJUSTES

<p>MAIN</p> <p>SYSTEM VOLTAGE</p> <p>+UB1</p>	-	<p> + + = 50%</p> <p>TV to AV : Black test pattern</p> <p>AV </p>		<table border="1"> <thead> <tr> <th>TUBE</th> <th>UB1 voltages</th> <th>JL990-992</th> </tr> </thead> <tbody> <tr><td>19V Thai</td><td>106V ± 2V</td><td>JL992</td></tr> <tr><td>19V ChungHwa</td><td>109V ± 2V</td><td>JL990 & JL991</td></tr> <tr><td>20V TF LGS</td><td>123V ± 2V</td><td>JL990 & JL991</td></tr> <tr><td>20V TF Orion</td><td>123V ± 2V</td><td>JL990 & JL991</td></tr> <tr><td>21" TF TTD II</td><td>123V ± 2V</td><td>JL990 & JL991</td></tr> <tr><td>21" OT</td><td>114V ± 2V</td><td>JL992</td></tr> <tr><td>25" TF Toshiba</td><td>126V ± 2V</td><td>JL992</td></tr> <tr><td>27V 1R TTD</td><td>126V ± 2V</td><td>JL990 & JL991</td></tr> <tr><td>27V VHP TTD</td><td>126V ± 2V</td><td>JL992</td></tr> <tr><td>27V/29" TF Samsung</td><td>126V ± 2V</td><td>JL992</td></tr> <tr><td>27V/29" TF TTD II</td><td>126V ± 2V</td><td>JL992</td></tr> <tr><td>28" MP</td><td>132V ± 2V</td><td>JL992</td></tr> <tr><td>33" MP</td><td>132V ± 2V</td><td>JL992</td></tr> <tr><td>32V/36 VHP</td><td>132V ± 2V</td><td>JL992</td></tr> <tr><td>32V TF Toshiba</td><td>132V ± 2V</td><td>JL992</td></tr> <tr><td>32V/34" TF TTD</td><td>132V ± 2V</td><td>JL992</td></tr> </tbody> </table>	TUBE	UB1 voltages	JL990-992	19V Thai	106V ± 2V	JL992	19V ChungHwa	109V ± 2V	JL990 & JL991	20V TF LGS	123V ± 2V	JL990 & JL991	20V TF Orion	123V ± 2V	JL990 & JL991	21" TF TTD II	123V ± 2V	JL990 & JL991	21" OT	114V ± 2V	JL992	25" TF Toshiba	126V ± 2V	JL992	27V 1R TTD	126V ± 2V	JL990 & JL991	27V VHP TTD	126V ± 2V	JL992	27V/29" TF Samsung	126V ± 2V	JL992	27V/29" TF TTD II	126V ± 2V	JL992	28" MP	132V ± 2V	JL992	33" MP	132V ± 2V	JL992	32V/36 VHP	132V ± 2V	JL992	32V TF Toshiba	132V ± 2V	JL992	32V/34" TF TTD	132V ± 2V	JL992
TUBE	UB1 voltages	JL990-992																																																					
19V Thai	106V ± 2V	JL992																																																					
19V ChungHwa	109V ± 2V	JL990 & JL991																																																					
20V TF LGS	123V ± 2V	JL990 & JL991																																																					
20V TF Orion	123V ± 2V	JL990 & JL991																																																					
21" TF TTD II	123V ± 2V	JL990 & JL991																																																					
21" OT	114V ± 2V	JL992																																																					
25" TF Toshiba	126V ± 2V	JL992																																																					
27V 1R TTD	126V ± 2V	JL990 & JL991																																																					
27V VHP TTD	126V ± 2V	JL992																																																					
27V/29" TF Samsung	126V ± 2V	JL992																																																					
27V/29" TF TTD II	126V ± 2V	JL992																																																					
28" MP	132V ± 2V	JL992																																																					
33" MP	132V ± 2V	JL992																																																					
32V/36 VHP	132V ± 2V	JL992																																																					
32V TF Toshiba	132V ± 2V	JL992																																																					
32V/34" TF TTD	132V ± 2V	JL992																																																					
<p>FOCUS</p>	LL05	<p> + + = 50%</p> <p></p> <p>Test pattern (standard values)</p>		Sharp picture																																																			
<p>U G2 / CUTOFF</p> <p>METHOD 1</p> <p>Measurement</p>	<p>LL05</p> <p>SCREEN</p> <p>Focus Block</p>	<p> + + = 50%</p> <p>TV to AV : Black test pattern</p> <p>AV </p>	<p>highest output</p> <p>R, G, B pins</p> <p>CRT socket</p>	<p>100:1 probe 2ms / div Y= 20V/div DC</p> <table border="1"> <thead> <tr> <th>Tube</th> <th>V Cut-off</th> </tr> </thead> <tbody> <tr><td>21" OT 90°</td><td>125V +/- 3V</td></tr> <tr><td>21" XF-TTD</td><td>125V +/- 3V</td></tr> <tr><td>21" XF Toshiba</td><td>125V +/- 3V</td></tr> <tr><td>28" MP</td><td>125V +/- 3V</td></tr> <tr><td>29" TF Samsung</td><td>125V +/- 3V</td></tr> <tr><td>29" XF TTD II</td><td>125V +/- 3V</td></tr> <tr><td>33" MP</td><td>125V +/- 3V</td></tr> <tr><td>34" XF TTD</td><td>125V +/- 3V</td></tr> </tbody> </table>	Tube	V Cut-off	21" OT 90°	125V +/- 3V	21" XF-TTD	125V +/- 3V	21" XF Toshiba	125V +/- 3V	28" MP	125V +/- 3V	29" TF Samsung	125V +/- 3V	29" XF TTD II	125V +/- 3V	33" MP	125V +/- 3V	34" XF TTD	125V +/- 3V																																	
Tube	V Cut-off																																																						
21" OT 90°	125V +/- 3V																																																						
21" XF-TTD	125V +/- 3V																																																						
21" XF Toshiba	125V +/- 3V																																																						
28" MP	125V +/- 3V																																																						
29" TF Samsung	125V +/- 3V																																																						
29" XF TTD II	125V +/- 3V																																																						
33" MP	125V +/- 3V																																																						
34" XF TTD	125V +/- 3V																																																						
<p>U G2 / CUTOFF</p> <p>METHOD 2</p> <p>SERVICE MODE</p> <p>(According to software version).</p>	SERVICE MODE	<p>Alternative method : see Service Mode p. 9 Autre méthode : voir réglage dans le service mode p. 9 Siehe Service Mode S. 9 Metodo alternativo : vedi Service Mode p.9 Método alternativo : ver Modo Servicio pág. 9</p>																																																					

EAST-WEST MODULE - MODULE EST-OUEST - OST-WEST-MODUL - MODULO EST-OVEST - MODULO ESTE-OESTE

<p>GEOMETRY</p>	<p>TV : AV1 Test pattern</p> <p>Standard TV - Settings :</p> <p> + + = 50%</p>		Correct picture	
<p>EWM</p>	<p>PL140</p> <p>PL141</p> <p>PL143</p> <p>SERVICE MODE</p>	<p>(GB) - Please refer to geometry Mode alignment (110° tube) , page 10, to adjust the East West Module (EWM)</p> <p>(F) - Se référer à la méthode d'alignement des géométries (tubes 110°), page 10 pour effectuer les réglages du Module Est-Ouest (EWM).</p> <p>(D) - Abgleich des Ost-West-Modules: Siehe Geometrie-Abgleich (110°), Seite 10.</p> <p>(I) - Per le regolazioni del Modulo Est-Ovest fare riferimento al modo allineamento geometria (tubi 110°), pagina 10.</p> <p>(E) - Para los ajustes del módulo Este-Oeste (EWM) ver la página 10, modo ajuste geometría (tubo 110°)</p> <div style="display: flex; justify-content: space-around; align-items: center;"> <div style="text-align: center;"> <p>PL140</p> </div> <div style="text-align: center;"> <p>PL141</p> </div> <div style="text-align: center;"> <p>PL143</p> </div> </div>		

SERVICE-MODE

It is necessary to enter the Service Mode in order to carry out alignment of the TV set. Most adjustments can be made with the RCU, except the Focus and Screen voltages.



1. Service Mode Access

- 1.1 With the RCU, switch the TV set into the "Standby" mode.
- 1.2 Switch "Off" the TV set by mains supply switch (wait until LED is dark).
- 1.3 Whilst pressing the "Magenta (text)" button on the RCU switch "On" the TV set using the mains switch.
Continue to press the "Magenta (text)" button until the Service-setup Sub-menu appears.

ET1 ID : S2.3	(1)
INIT < / >	(2)

2. Service Menu

2.1 Navigation

- Press the  buttons to select the menu line.
- Press the  buttons to make adjustments or selection of a menu item.

2.2 Service-Menu lines

Set-up lines (INIT,KEY,LOCK,LIMIT) -
Video lines (VG2, AGC, BKS, OS-B, PKWS, WPBS, WPGS, WPRS, BLOGS, BLORS, YD, CL).
Geometry lines (VSH, SC, VA, VS, HSH)
IF/SET-UP lines (OIF,SOC)

2.3 Activation of a line :

The first line (1) is continuously displayed. Sequential selection of the others lines in the Service Menu is possible by pressing the  buttons on the RCU.

3. Alignment and storing new function value

- 3.1 The current value of the selected function is displayed in a hexadecimal form to the right of the function name. This value is adjusted by means of the RCU  buttons.
- 3.2 The values will be stored in the non-volatile memory when leaving the service menu or switching the TV into standby mode.

4. Temporary exit from Service Mode

- 4.1 To temporary leave the Service Mode, press the "Exit" button on the RCU. To access the everyday menus, press the "Menu" button on the RCU.
- 4.2 To return to the Service Menu, press the "Magenta" button on the RCU

5. Leaving the Service Mode

- 5.1 To EXIT the Service Menu either press, the "Standby" button on the RCU or switch "Off" the mains supply to the TV.

MODE SERVICE

Le mode service sert au réglage de l'appareil. Toutes les opérations de réglage s'effectuent à l'aide de la télécommande (sauf les réglages de Focus et de tension de grille-écran).



1. Accès au mode service

- 1.1 Commuter le téléviseur en position de veille avec la télécommande.
- 1.2 Eteindre le téléviseur par l'interrupteur secteur (attendre l'extinction complète du voyant).
- 1.3 Maintenir la touche "Magenta (text)" enfoncée et mettre simultanément le téléviseur en marche avec l'interrupteur secteur.
Ne pas relâcher la touche "Magenta (text)" jusqu'à apparition du menu

ET1 ID : S2.3	(1)
INIT	(2)

2. Menu Service

2.1 Déplacement

- Appuyer sur la touche  pour sélectionner une ligne de menu.
- Appuyer sur la touche  pour un réglage ou une sélection d'une option.

2.2 Lignes de Menus du mode service

Set-up lines (INIT,KEY,LOCK,LIMIT) -
Video lines (VG2, AGC, BKS, OS-B, PKWS, WPBS, WPGS, WPRS, BLOGS, BLORS, YD, CL).
Geometry lines (VSH, SC, VA, VS, HSH)
IF/SET-UP lines (OIF,SOC)

2.3 Sélection d'une ligne:

La première ligne (1) du menu est toujours affichée.
De courtes pressions sur la touche "" sélectionnent séquentiellement la ligne (2).

3. Réglage des fonctions sélectionnées; mémorisation

- 3.1 La valeur momentanée de la fonction sélectionnée est indiquée sous forme hexadécimale à droite, à coté de la position à régler et peut être modifiée avec la télécommande par la touche .
- 3.2 La valeur de réglage est mémorisée dans la mémoire non volatile en sortie de mode service ou en mettant le TV en position de veille.

4. Sortie temporaire du mode service

- 4.1 Utiliser la touche "Exit" de la télécommande.
Le menu utilisateur peut-être accessible via la touche "Menu".
- 4.2 Pour entrer à nouveau dans le Menu Setup utiliser la touche magenta.

5. Sortie du mode service

- 5.1 Pour sortir du mode service, commuter le téléviseur en position de veille ou le mettre hors service par l'interrupteur secteur.

SERVICE-MODE

Der Service-Mode wird für den Geräteabgleich benötigt. Alle Einstellungen erfolgen mit der Fernbedienung (bis auf Fokuseinstellung und Schirmgitterspannung).



1. Service-Mode einschalten

- 1.1 Mit der Fernbedienung das Fernsehgerät in Stand-by schalten.
- 1.2 Das Gerät mit dem Netzschalter ausschalten (warten bis LED dunkel ist)
- 1.3 Während Sie die margentafarbene Taste (**text**) auf der Fernbedienung gedrückt halten, schalten Sie das Gerät mit dem Netzschalter ein. Halten Sie die margentafarbene Taste solange gedrückt bis das Service Setup Sub-Menü erscheint.

ET1 ID : S2.3	(1)
INIT	(2)

2. Service Menü

2.1 Navigation

- Drücken Sie die Tasten  zum Auswählen der Menüzeile.
- Drücken Sie die  -Tasten um eine Menüfunktion anzuwählen oder abzugleichen.

2.2 Service-Menü Zeilen

Set-up lines (INIT,KEY,LOCK,LIMIT) -
Video lines (VG2, AGC, BKS, OS-B, PKWS, WPBS, WPGS, WPRS, BLOGS, BLORS, YD, CL).
Geometry lines (VSH, SC, VA, VS, HSH)
IF/SET-UP lines (OIF,SOC)

2.3 Aktivierung einer Menüzeile:

Die erste Zeile (1) wird ständig angezeigt. Die Anwahl der Zeilen (2) im Service-Menü ist durch Drücken der  -Tasten möglich.

3. Abgleich der gewählten Funktion und Speichern

- 3.1 Der momentane Wert der gewählten Funktion wird hexadezimal rechts neben der abzugleichenden Position angegeben und kann mit der Taste  auf der Fernbedienung verändert werden.
- 3.2 Die Werte werden nach dem Abschalten des Gerätes in Standby oder nach dem Verlassen des Service-Menüs im nichtflüchtigen Speicher (EEPROM) abgelegt.

4. Vorübergehendes verlassen des Service-Mode

- 4.1 Auf der Fernbedienung Exit drücken.
Mit der Tasten Menü gelangen Sie zum Menü-Übersicht.
- 4.2 Durch Drücken der margentafarbenen Taste gelangen Sie in das Service Setup Sub-Menü.

5. Service-Mode verlassen

- 5.1 Zum Verlassen des Service-Mode das Gerät in Stand By schalten oder mit dem Netzschalter ausschalten.

MODO SERVICIO



Se necesita el MODO SERVICIO para ajustar el aparato. Todos los ajustes se hacen con el mando a distancia (a excepción de la tensión del sistema, los ajustes del foco y las tensiones de la rejilla de pantalla).

1. Ajustar el Modo Servicio

- 1.1 Con el mando a distancia conectar a STANDBY el televisor.
- 1.2 Desconectar el aparato con el interruptor de la red (esperar hasta que el LED se apague).
- 1.3 Mientras mantiene pulsado el botón "Magenta (texto)" de la UCR, pulse el interruptor general de red para encender el televisor.
Mantenga pulsado el botón "Magenta (texto)" hasta que aparezca el submenú de la configuración del servicio.

ET1 ID : S2.3	(1)
INIT	(2)

2. Menú Servicio.

- 2.1 Desplazamiento
- Pulse el botón  para seleccionar la línea del menú.
- Pulse el botón  para ajustar o seleccionar una opción del menú.

SERVICE-MODE

Il Service-Mode è necessario per l'allineamento dell'apparecchio. Tutte le regolazioni si effettuano con il telecomando. (tranne le regolazioni del fuoco e le tensioni della griglia schermo).



1. Attivazione del Service-Mode

- 1.1 Commutare il televisore in stand-by con il telecomando.
- 1.2 Spegner l'apparecchio con l'interruttore di rete (attendere finché il LED è spento)
- 1.3 Mentre tenete premuto il pulsante "Magenta (testo)" del RCU, accendete il televisore utilizzando l'interruttore di rete. Continuate a premere il pulsante "Magenta (testo)" del RCU fino all'apparizione del Service Setup Sub Menu

ET1 ID : S2.3	(1)
INIT	(2)

2. Service Menu

2.1 Navigazione

- Premere i tasti  per selezionare la linea del menu
- Premere i tasti  per la regolazione o la selezionz di un elemento del menu

2.2 Linee Service Menu

Set-up lines (INIT,KEY,LOCK,LIMIT) -
Video lines (VG2, AGC, BKS, OS-B, PKWS, WPBS, WPGS, WPRS, BLOGS, BLORS, YD, CL).
Geometry lines (VSH, SC, VA, VS, HSH)
IF/SET-UP lines (OIF,SOC)

2.3 Attivazione di una linea :

La prima linea (1) è continuamente visualizzata. La selezione delle linee successive (2) è possibile in service menu premendo i tasti .

3. Taratura della funzione scelta e memorizzazione

- 3.1 Il valore momentaneo della funzione scelta viene indicato in formato esadecimale a destra, accanto alla posizione da allineare e può essere cambiato con il pulsante  del telecomando.
- 3.2 I valori verranno memorizzati nella memoria num quando verrà lasciato il menù service mode o commutando il TV in modo standby.

4. Uscita temporanea dal Service Mode

- 4.1 Premere Exit sul telecomando.
Al menu di uso quotidiano si accede attraverso il pulsante Menu.
- 4.2 Il Service Setup Sub Menu è accessibile attraverso il tasto "Magenta".

5. Disattivazione del Service-Mode

- 5.1 Per disattivare il Service Mode, commutare l'apparecchio in stand-by o spegnerlo con l'interruttore di rete.

Set-up lines (INIT,KEY,LOCK,LIMIT) -
Video lines (VG2, AGC, BKS, OS-B, PKWS, WPBS, WPGS, WPRS, BLOGS, BLORS, YD, CL).
Geometry lines (VSH, SC, VA, VS, HSH)
IF/SET-UP lines (OIF,SOC)

2.3 Activación de una línea :
La primera línea (1) se muestra siempre en la pantalla. La selección secuencial de las líneas (2), es posible pulsando las teclas .

3. Ajuste de la función elegida y almacenamiento

- 3.1 El valor momentáneo de la función elegida es indicado de modo hexadecimal a la derecha, al lado de la posición a ajustar, y puede cambiarse con la tecla  en el mando a distancia.
- 3.2 Los valores serán memorizados en la EEPROM al salir del menú del Modo Servicio o pasando el TV a modo standby.

4. Salida temporal del Modo Servicio







- 4.1 Pulse Salir en el mando a distancia.
Con el botón Menu puede acceder al menú de uso cotidiano.
- 4.2 Puede acceder al submenú de configuración del servicio mediante el botón "Magenta".

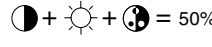

5. Salir del Modo Servicio

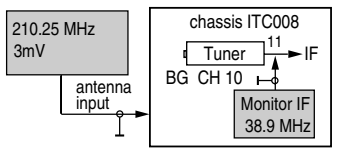
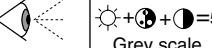
- 5.1 Conmute el aparato a STANDBY a fin de salir del MODO SERVICIO o desconectar con el interruptor de la red.

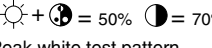
ALIGNMENT PROCEDURE - PROCESSUS DE REGLAGES - ABGLEICH - VISUALIZZAZIONE DEL VALORE DI REGOLAZIONE - PROCEDIMIENTO DE ALINEACION



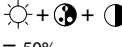
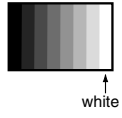
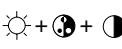
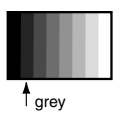





SET-UP LINES	
ET1 ID: S2.3	
INIT	
KEY	Off
LOCK	Off
LIMIT	<0-63> 32
ET1 ID:S2.3	
INIT Initialise TV set. Press "OK" button. Sets all Service Mode functions stored in the EEPROM to their default values. See below the default values table.	
⚠ "INIT" copy all service parameters from the ROM to EEPROM. It will be necessary in this case to readjust most of the service mode functions.	
⚠ "INIT" copie toutes les valeurs par défaut stockées en ROM vers l'EEPROM. Il peut être nécessaire dans ce cas de reprendre la plupart des réglages du mode service.	
⚠ "INIT" kopiert alle Service-Parameter aus dem ROM in das EEPROM. Es ist anschließend notwendig die meisten Service-Funktionen neu abzugleichen	
⚠ "INIT" copia tutti i parametri di servizio dalla ROM alla EEPROM. Sarà necessario in seguito regolare alcune funzioni in Service Mode.	
⚠ "INIT" copia todos los valores por defecto memorizados en la ROM hacia la EEPROM. Puede ser necesario en el caso de tener que reajustar la mayor parte de los ajustes en Modo Servicio	
Key Lock Pr+ Pr- on the front panel	ON : Disable the PR keys. Touches PR du clavier inactives. Disable the PR keys. Disable the PR keys. Disable the PR keys.
Lock for Hotel Mode	Factory Setting
Limit for Volume control	Factory Setting

VIDEO LINES																			
VG2	03																		
AGC	34																		
BKS*	01																		
OS-B	02																		
PKWS*	36 33 33																		
WPBS*	33																		
WPGS*	33																		
WPRS*	36																		
BLOGS*	37																		
BLORS*	32																		
YD	00																		
CL	11																		
VG2 G2 Alignment	 = 50% TV to AV or RF : White box test pattern in center. white = 100% Adjust G2 with the SCREEN potentiometer (LL005) to get 03. Régler G2 avec le potentiomètre SCREEN (LL005) pour obtenir 03 Gleichen Sie G2 mit dem SCREEN-Potentiometer (LL005): VG2=03 Regular il potenziometro G2 SCREEN (LL005) : VG2=03 Ajustar la G2 con el potenciómetro SCREEN (LL005): VG2=03.																		
AGC	 = 50% AGC - Automatic Gain Control alignment - Minimum noise- Minimum de bruit - Minimum Rauschen - Rumore minimo - Minimo ruido 																		
	- Set AGC to 00 - Adjust AGC for maximum gain of IF signal. - Reduce IF level about 8dB. ROM Default Value : AGC : 20																		
BKS Black Stretch	Factory Setting																		
OS_B Sub-Brightness	 = 50% Grey scale test pattern white =100% TV : BG or L 																		
PKWS / PKWP**	 = 50%  = 70% Peak white test pattern. white = 100% colourimeter <table border="1"> <thead> <tr> <th>Sets</th> <th>Nits</th> </tr> </thead> <tbody> <tr> <td>21" OT 90° sets</td> <td>420 +/- 10%</td> </tr> <tr> <td>21" XF-TTD</td> <td>420 +/- 10%</td> </tr> <tr> <td>25" XF Toshiba</td> <td>300 +/- 10%</td> </tr> <tr> <td>28" MP</td> <td>300 +/- 10%</td> </tr> <tr> <td>29" XF-Samsung</td> <td>200 +/- 10%</td> </tr> <tr> <td>29" XF TTD II</td> <td>250 +/- 10%</td> </tr> <tr> <td>33" MP</td> <td>250 +/- 10%</td> </tr> <tr> <td>34" XF TTD</td> <td>200 +/- 10%</td> </tr> </tbody> </table>	Sets	Nits	21" OT 90° sets	420 +/- 10%	21" XF-TTD	420 +/- 10%	25" XF Toshiba	300 +/- 10%	28" MP	300 +/- 10%	29" XF-Samsung	200 +/- 10%	29" XF TTD II	250 +/- 10%	33" MP	250 +/- 10%	34" XF TTD	200 +/- 10%
Sets	Nits																		
21" OT 90° sets	420 +/- 10%																		
21" XF-TTD	420 +/- 10%																		
25" XF Toshiba	300 +/- 10%																		
28" MP	300 +/- 10%																		
29" XF-Samsung	200 +/- 10%																		
29" XF TTD II	250 +/- 10%																		
33" MP	250 +/- 10%																		
34" XF TTD	200 +/- 10%																		

Drive**		 = 50% Grey scale test pattern white =100% 
WPRS / WPRP White Point Red SECAM/PAL		
WPGS / WPGP White Point Green SECAM/PAL		
WPBS / WPBP White Point Blue SECAM/PAL		
Cut-off **		 = 50% Grey scale test pattern white =100% 
BLORS / BLORP Black Level Offset Red SECAM/PAL		
BLOGS / BLOGP Black Level Offset Green SECAM/PAL		
YD Luminance Delay		Use  to adapt the image
CL Cathode Level	Factory setting. Extension of the peak White range. Réglage usine. Extension des valeurs de réglages du Peak White. Fabrik-Einstellung (Umfang des Spitzenweiß Einbereiches) Factory Setting. Extension of the peak White range. Ajuste de fábrica Extensión del margen del Peak White.	

*Perform the G2 and the Focus settings beforehand.
Effectuez au préalable les réglages de G2 et de focus.
Stellen Sie zuvor G2 und "Focus" ein.
Effettuare le regolazioni G2 e del Fuoco innanzitutto.
Efectuar previamente los ajustes de G2 y Foco

** Adjust separate for PAL / SECAM
" S " : Video signal received is SECAM.
" P " : Video signal received is PAL.

GEOMETRY LINES		
VSH	32	
SC	27	
VA	37	
VS	38	
HSH	37	
VSH		
SC S-Correction		
VA		
VS V_Slope	- Apply a test pattern signal to the TV with a single horizontal and vertical line on the screen. - Select the "VS" line of the menu. The bottom half of the screen will go black. - Adjust VS until the centre line of the pattern is just invisible. - Leave the line "V_Slope". - Switch the test pattern signal to the crosshatch geometry pattern. - Perform the geometry adjustments described below. - Appliquer une mire de barres avec seulement une ligne blanche horizontale en milieu de l'écran. - Sélectionner la ligne "V_Slope". - La moitié basse de l'écran devient noire. - Aligner "V_Slope" pour que la ligne médiane soit à peine non visible. - Commuter la mire en mode de réglage de géométrie (quadrillage). - Effectuer les réglages de géométrie ci-après. - Speisen Sie ein Testbild mit einem horizontalen Strich in der Bildmitte ein. - Wählen Sie im Menü die Funktion "V_Slope" an. - Die untere Bildhälfte wird dunkel. - Stellen Sie "V_Slope" so ein, daß die Mittellinie fast verschwindet. - Verlassen Sie die Funktion "V_Slope". - Speisen Sie ein Gittertestbild ein. - Nehmen Sie die Geometrieinstellungen wie nebenstehend beschrieben vor. - Applicare un monoscopio con un'unica linea bianca orizzontale al centro dello schermo - Selezionare la riga "V slope" del menu. La parte bassa dello schermo viene oscurata. - Allineare la "Vertical Slope" in modo che la linea centrale sia appena visibile - Abbandonare la riga "V slope". - Posizionare il monoscopio - Effettuare le regolazioni di geometria descritte in precedenza - Memorizzare. - Aplique una carta de ajuste con sólo una línea blanca horizontal y una vertical en el centro de la pantalla. - Seleccionar en el menú, la línea "V_Slope". La mitad inferior de la pantalla se pondrá oscura. - Ajuste "V_Slope" justo hasta que la línea horizontal sea invisible. - Cambiar la carta de ajuste a "cuadrícula" y efectuar los ajustes de geometría descritos a continuación - Antes de salir, memorizar con "Store"	
HSH		

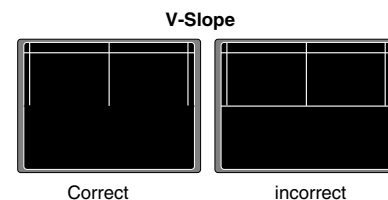





IF / SET-UP LINES	
OIF	24
OIF Offset IF demodulator	Factory Setting OIF=24H

VIDEO PROCESSOR LINES*	
SOC*	03
SOC* Peak White Limiting	Factory Setting SOC=03H



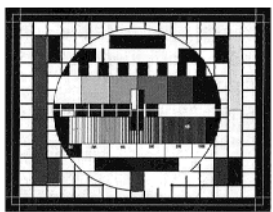



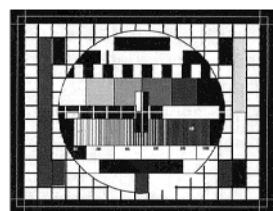

* According to software version.
Selon version de software.

GEOMETRY MODE ALIGNMENT

90° tube
Signal : 50 Hz - 4/3 test pattern

4 / 3 standard mode	Overscan V=107% , H=107%
	1 - Adjust Horizontal Centering (HS)  2 - Adjust Vertical centering (VSH) and Vertical amplitude 107% (VA) 3 - Adjust Vertical Slope (VS) and linearity (SC)    4-If necessary repeat VSH, VA alignment to 7% overscan.

110° tube
Signal : 50 Hz - 4/3 test pattern

4 / 3 standard mode	Overscan V=107% , H=107%
	EAST-WEST MODULE 1 - PL140 : Turn fully counterclockwise. MAIN BOARD 2 - Adjust Horizontal Centering (HS)  3 - Adjust Vertical centering (VSH) and Vertical amplitude 107% (VA) 4 - Adjust Vertical Slope (VS) and linearity (SC)    5 - If necessary repeat VSH, VA alignment to 7% overscan. EAST-WEST MODULE 6 - PL140 : Adjust Horizontal amplitude with PL140 for optimum overscan.  7 - PL141 : Adjust Pincushion.  8 - PL143 : Adjust Trapezium  9 -If necessary repeat Horizontal amplitude, pincushion correction and trapezium alignment