

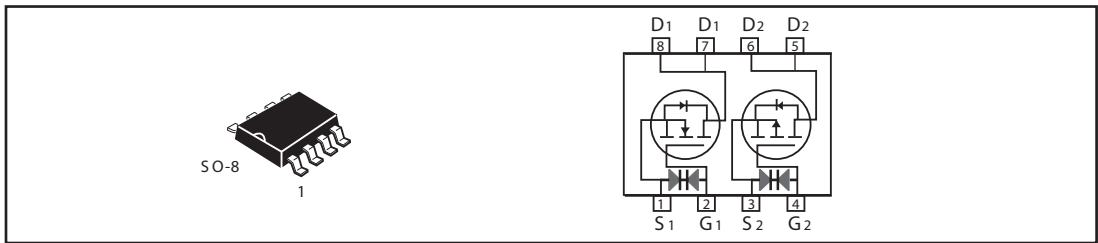

Dual Enhancement Mode Field Effect Transistor (N and P Channel)

PRODUCT SUMMARY (N-Channel)		
V _{DSS}	I _D	R _{DS(ON)} (mΩ) Max
30V	7A	23 @ V _{GS} = 10V
		30 @ V _{GS} = 4.5V

PRODUCT SUMMARY (P-Channel)		
V _{DSS}	I _D	R _{DS(ON)} (mΩ) Max
-30V	-6A	35 @ V _{GS} = -10V
		52 @ V _{GS} = -4.5V



ABSOLUTE MAXIMUM RATINGS (T_A=25°C unless otherwise noted)

Parameter	Symbol	N-Channel	P-Channel	Unit
Drain-Source Voltage	V _{DS}	30	-30	V
Gate-Source Voltage	V _{GS}	±20	±20	V
Drain Current-Continuous ^a @ T _J =25°C -Pulsed ^b	I _D	7	-6	A
	I _{DM}	28	-24	A
Drain-Source Diode Forward Current ^a	I _S	1.7	-1.7	A
Maximum Power Dissipation ^a	P _D	2.0		W
Operating Junction and Storage Temperature Range	T _J , T _{STG}	-55 to 150		°C

THERMAL CHARACTERISTICS

Thermal Resistance, Junction-to-Ambient ^a	R _{θJA}	62.5	°C/W
--	------------------	------	------

STM8309

N-Channel ELECTRICAL CHARACTERISTICS ($T_A = 25\text{ }^{\circ}\text{C}$ unless otherwise noted)

Parameter	Symbol	Condition	Min	Typ ^c	Max	Unit
OFF CHARACTERISTICS						
Drain-Source Breakdown Voltage	BV_{DSS}	$V_{GS}=0V, I_D=250\mu A$	30			V
Zero Gate Voltage Drain Current	I_{DSS}	$V_{DS}=24V, V_{GS}=0V$			1	μA
Gate-Body Leakage	I_{GSS}	$V_{GS}=\pm 20V, V_{DS}=0V$			± 10	μA
ON CHARACTERISTICS^b						
Gate Threshold Voltage	$V_{GS(th)}$	$V_{DS}=V_{GS}, I_D=250\mu A$	1.0	1.9	3	V
Drain-Source On-State Resistance	$R_{DS(ON)}$	$V_{GS}=10V, I_D=7A$		17	23	m ohm
		$V_{GS}=4.5V, I_D=5A$		23	30	m ohm
On-State Drain Current	$I_{D(ON)}$	$V_{DS}=15V, V_{GS}=10V$	20			A
Forward Transconductance	g_{FS}	$V_{DS}=10V, I_D=7A$		14		S
DYNAMIC CHARACTERISTICS^c						
Input Capacitance	C_{ISS}	$V_{DS}=15V, V_{GS}=0V$ $f=1.0MHz$		680		pF
Output Capacitance	C_{OSS}			190		pF
Reverse Transfer Capacitance	C_{RSS}			115		pF
SWITCHING CHARACTERISTICS^c						
Turn-On Delay Time	$t_{D(ON)}$	$V_{DD}=15V,$ $I_D=7A,$ $R_L=2.1\text{ ohm},$ $V_{GS}=10V,$ $R_{GEN}=6\text{ ohm}$		12		ns
Rise Time	t_r			17.5		ns
Turn-Off Delay Time	$t_{D(OFF)}$			41		ns
Fall Time	t_f			15		ns
Total Gate Charge	Q_g	$V_{DS}=15V, I_D=7A, V_{GS}=10V$		11		nC
		$V_{DS}=15V, I_D=7A, V_{GS}=4.5V$		5.5		nC
Gate-Source Charge	Q_{gs}	$V_{DS}=15V, I_D=7A,$ $V_{GS}=10V$		1.7		nC
Gate-Drain Charge	Q_{gd}			3.3		nC

STM8309

P-Channel ELECTRICAL CHARACTERISTICS ($T_A=25^{\circ}\text{C}$ unless otherwise noted)

Parameter	Symbol	Condition	Min	Typ ^c	Max	Unit
OFF CHARACTERISTICS						
Drain-Source Breakdown Voltage	BV_{DSS}	$V_{GS}=0V, I_D=-250\mu A$	-30			V
Zero Gate Voltage Drain Current	I_{DSS}	$V_{DS}=-24V, V_{GS}=0V$			-1	μA
Gate-Body Leakage	I_{GSS}	$V_{GS}=\pm 20V, V_{DS}=0V$			± 10	μA
ON CHARACTERISTICS^b						
Gate Threshold Voltage	$V_{GS(th)}$	$V_{DS}=V_{GS}, I_D=-250\mu A$	-1	-1.9	-3	V
Drain-Source On-State Resistance	$R_{DS(ON)}$	$V_{GS}=-10V, I_D=-5A$		29	35	m ohm
		$V_{GS}=-4.5V, I_D=-4A$		44	52	m ohm
On-State Drain Current	$I_{D(ON)}$	$V_{DS}=-15V, V_{GS}=-10V$	-20			A
Forward Transconductance	g_{FS}	$V_{DS}=-15V, I_D=-5A$		8.5		S
DYNAMIC CHARACTERISTICS^c						
Input Capacitance	C_{ISS}	$V_{DS}=-15V, V_{GS}=0V$ $f=1.0MHz$		870		pF
Output Capacitance	C_{OSS}			225		pF
Reverse Transfer Capacitance	C_{RSS}			125		pF
SWITCHING CHARACTERISTICS^c						
Turn-On Delay Time	$t_{D(ON)}$	$V_D=-15V,$ $R_L=15\text{ ohm},$ $I_D=-1A,$ $V_{GEN}=-10V,$ $R_{GEN}=6\text{ ohm}$		12		ns
Rise Time	t_r			18		ns
Turn-Off Delay Time	$t_{D(OFF)}$			70		ns
Fall Time	t_f			40		ns
Total Gate Charge	Q_g	$V_{DS}=-15V, I_D=-5A, V_{GS}=-10V$		15		nC
		$V_{DS}=-15V, I_D=-5A, V_{GS}=-4.5V$		7.5		nC
Gate-Source Charge	Q_{gs}	$V_{DS}=-15V, I_D=-5A,$ $V_{GS}=-10V$		1.7		nC
Gate-Drain Charge	Q_{gd}			4.5		nC

STM8309

ELECTRICAL CHARACTERISTICS ($T_A=25^{\circ}\text{C}$ unless otherwise noted)

Parameter	Symbol	Condition	Min	Typ ^c	Max	Unit
DRAIN-SOURCE DIODE CHARACTERISTICS^b						
Diode Forward Voltage	V_{SD}	$V_{GS} = 0\text{V}, I_S = 1.7\text{A}$	N-Ch	0.8	1.2	V
		$V_{GS} = 0\text{V}, I_S = -1.7\text{A}$	P-Ch	-0.8	-1.2	

Notes

- a. Surface Mounted on FR4 Board, $t \leq 10\text{sec}$.
 - b. Pulse Test: Pulse Width $\leq 300 \mu\text{s}$, Duty Cycle $\leq 2\%$.
 - c. Guaranteed by design, not subject to production testing.
- N-Channel

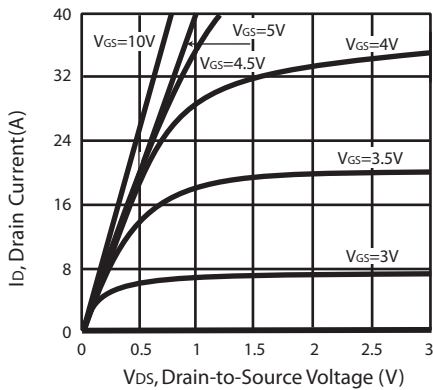

Figure 1. Output Characteristics

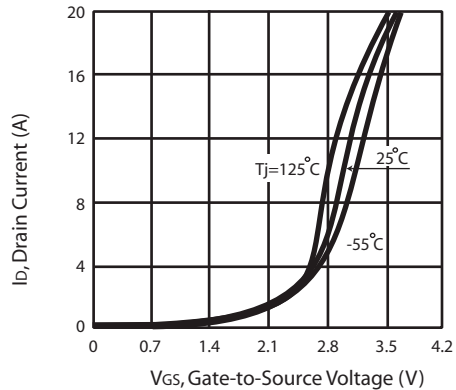

Figure 2. Transfer Characteristics

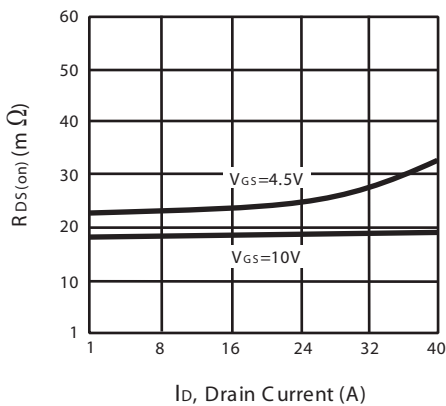

Figure 3. On-Resistance vs. Drain Current and Gate Voltage

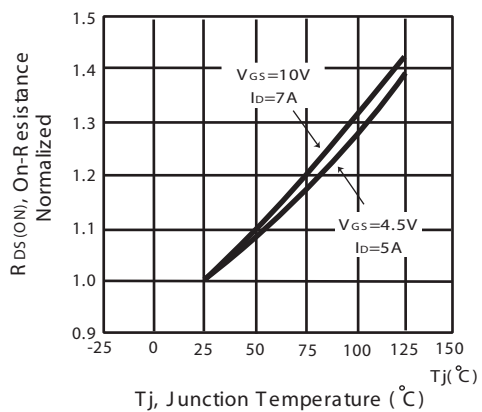

Figure 4. On-Resistance Variation with Drain Current and Temperature

STM8309

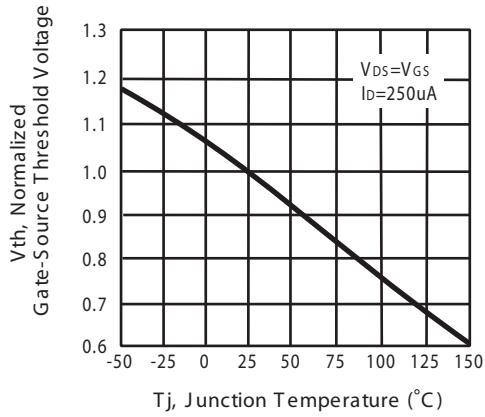

Figure 5. Gate Threshold Variation with Temperature

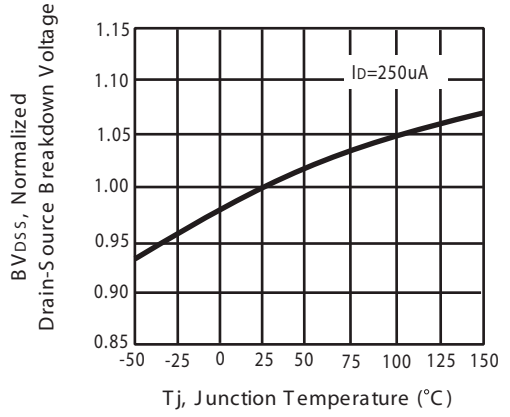

Figure 6. Breakdown Voltage Variation with Temperature

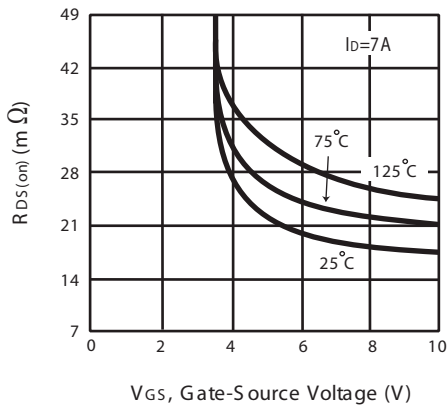

Figure 7. On-Resistance vs. Gate-Source Voltage

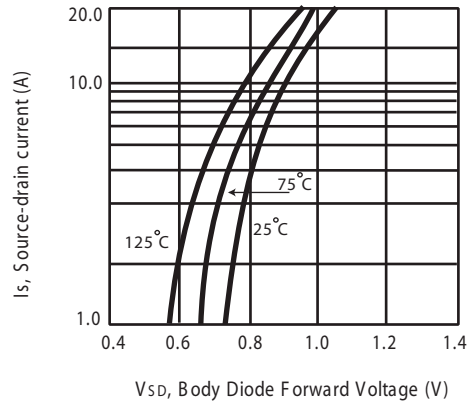

Figure 8. Body Diode Forward Voltage Variation with Source Current

STM8309

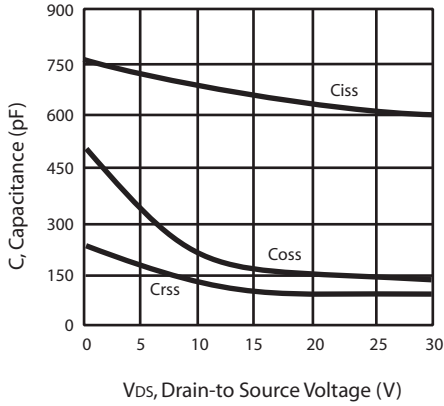

Figure 8. Capacitance

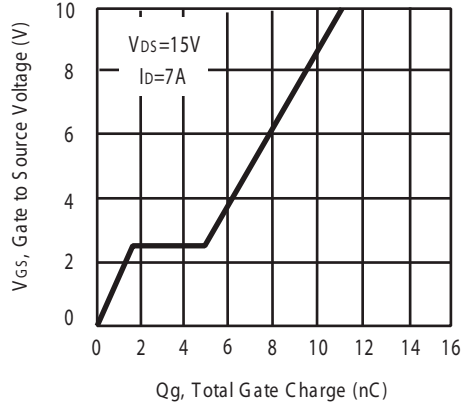

Figure 9. Gate Charge

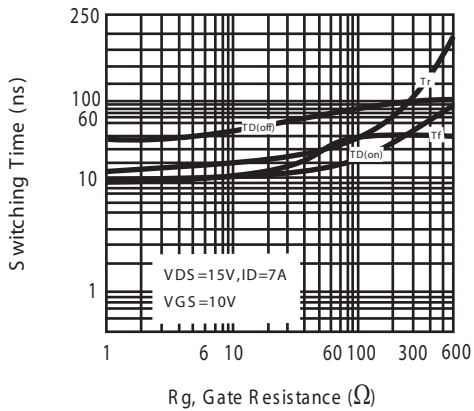

Figure 11. switching characteristics

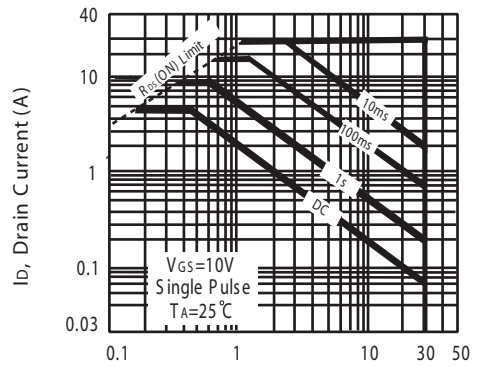

Figure 10. Maximum Safe Operating Area

STM8309

P-Channel

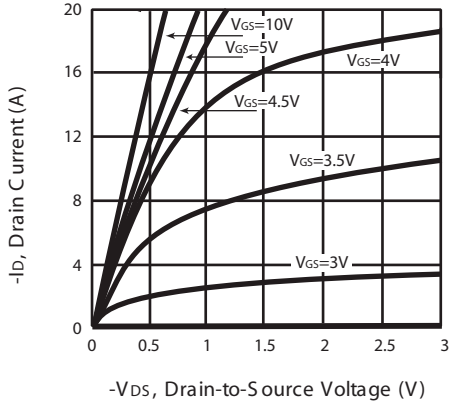

Figure 1. Output Characteristics

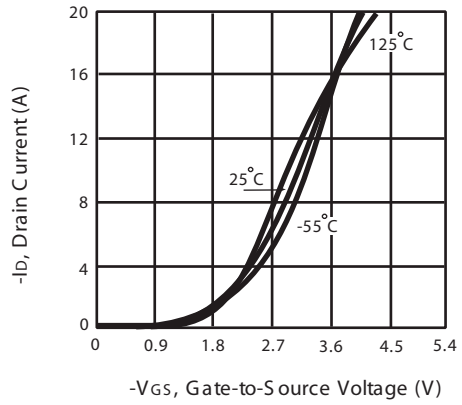

Figure 2. Transfer Characteristics

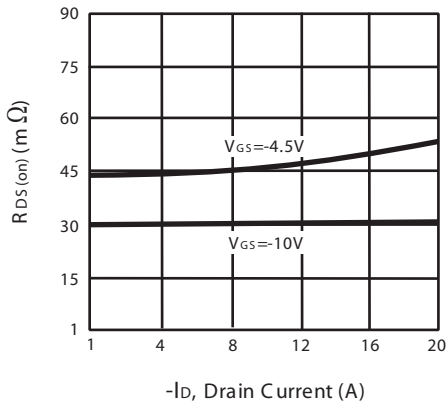

Figure 3. On-Resistance vs. Drain Current and Gate Voltage

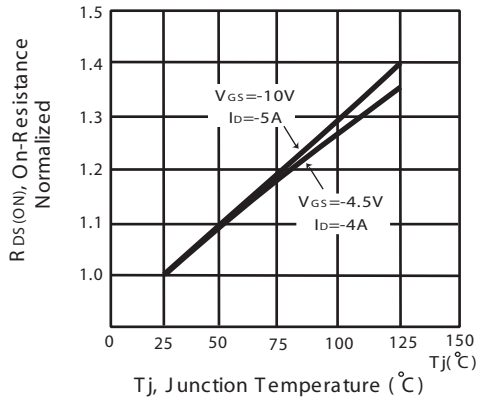
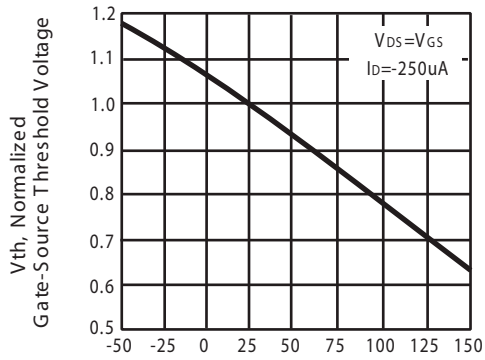

Figure 4. On-Resistance Variation with Drain Current and Temperature

STM8309



T_j , Junction Temperature (°C)

Figure 5. Gate Threshold Variation with Temperature

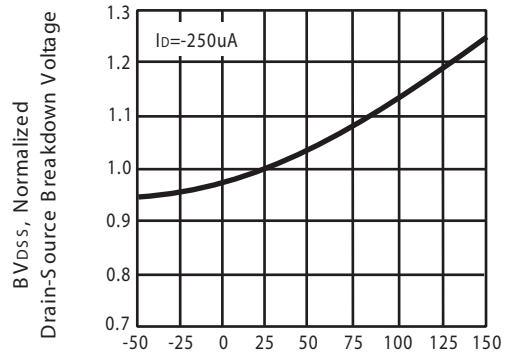

T_j , Junction Temperature (°C)

Figure 6. Breakdown Voltage Variation with Temperature

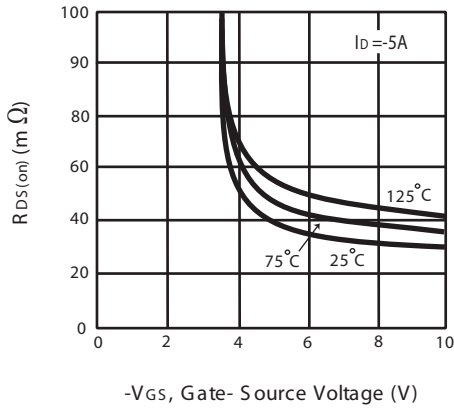

$-V_{GS}$, Gate- Source Voltage (V)

Figure 7. On-Resistance vs. Gate-Source Voltage

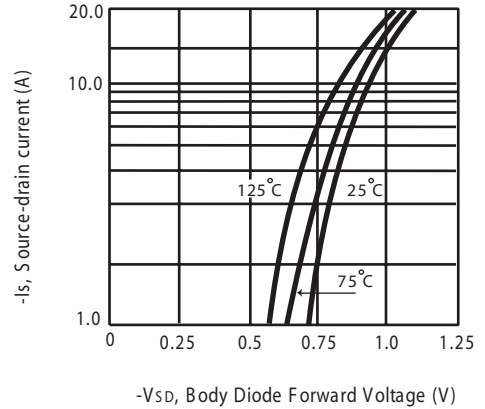

$-V_{SD}$, Body Diode Forward Voltage (V)

Figure 8. Body Diode Forward Voltage Variation with Source Current

STM8309

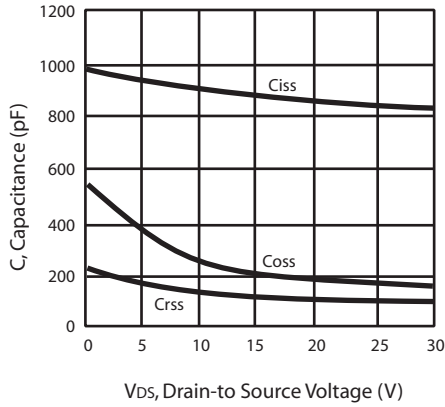

Figure 8. Capacitance

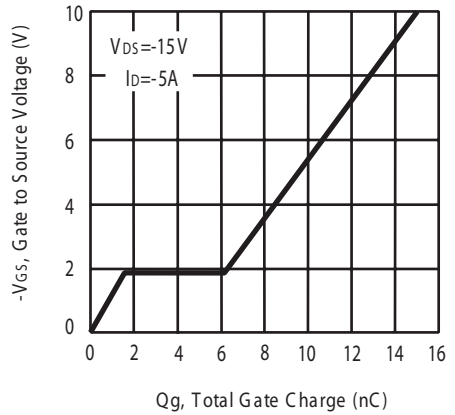

Figure 9. Gate Charge

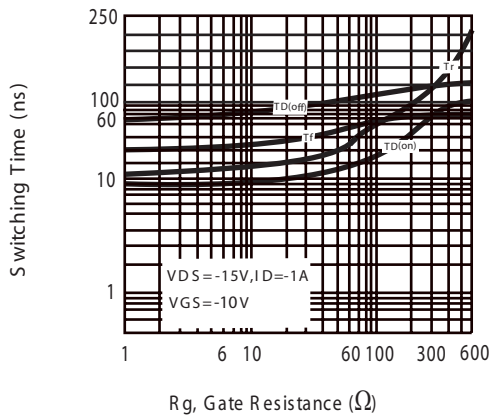

Figure 11. switching characteristics

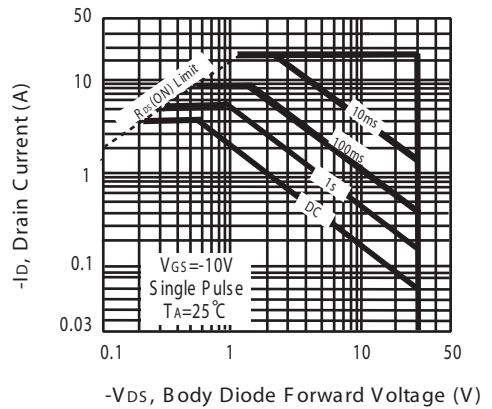

Figure 10. Maximum Safe Operating Area

STM8309

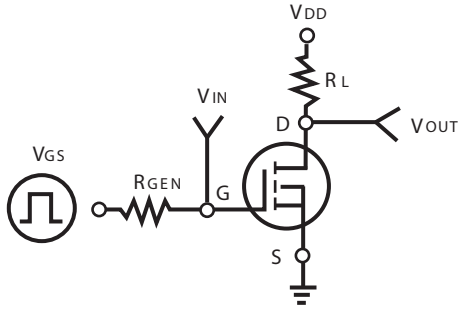

Figure 13. Switching Test Circuit

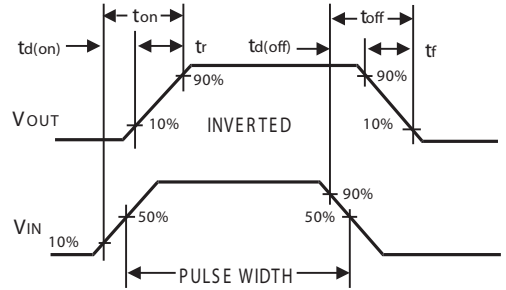
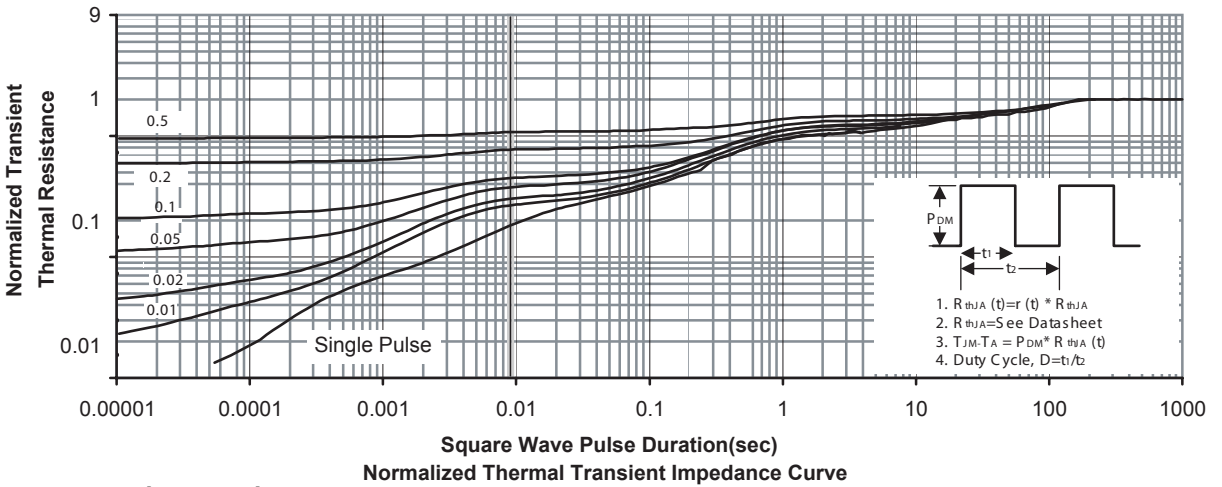
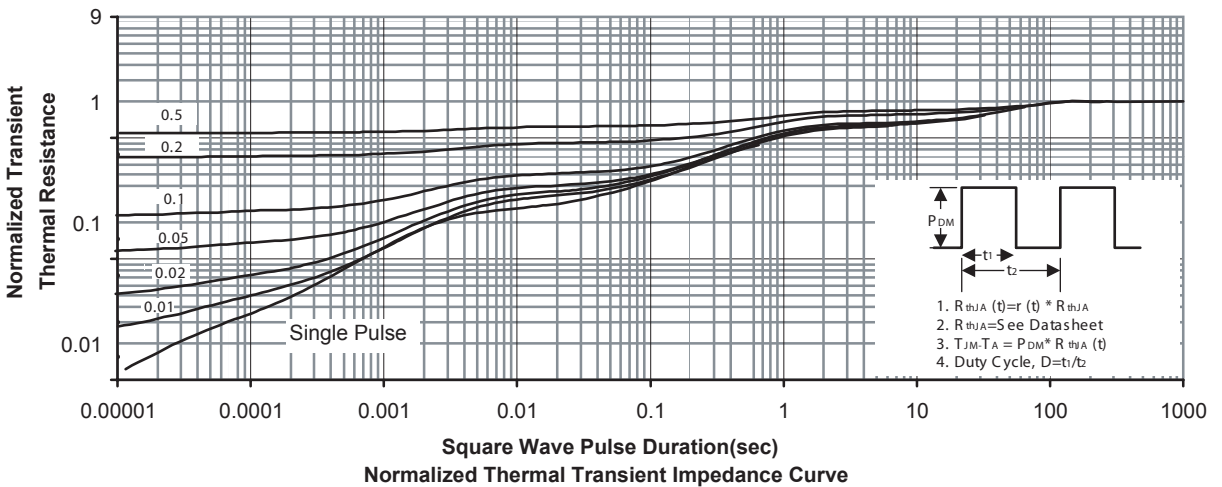

Figure 14. Switching Waveforms

N-Channel



P-Channel



STM8309

PACKAGE OUTLINE DIMENSIONS

SO-8

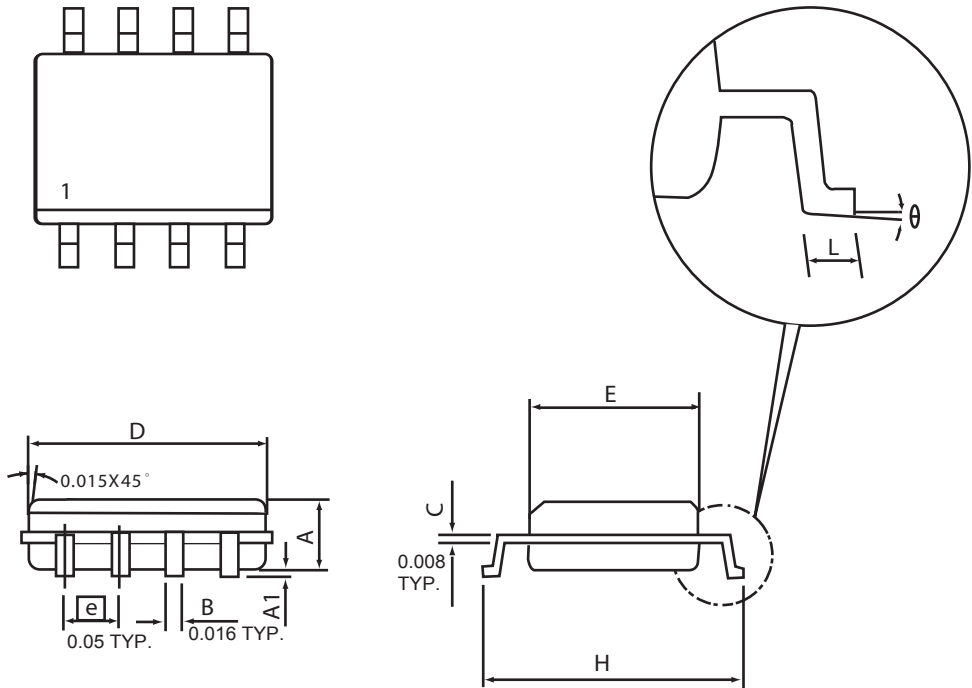

SYMBOLS	MILLIMETERS		INCHES	
	MIN	MAX	MIN	MAX
A	1.35	1.75	0.053	0.069
A1	0.10	0.25	0.004	0.010
D	4.80	4.98	0.189	0.196
E	3.81	3.99	0.150	0.157
H	5.79	6.20	0.228	0.244
L	0.41	1.27	0.016	0.050
θ	0°	8°	0°	8°