



STTA512D/F/B

TURBOSWITCH™ ULTRA-FAST HIGH VOLTAGE DIODE

MAIN PRODUCT CHARACTERISTICS

$I_{F(AV)}$	5A
V_{RRM}	1200V
t_{rr} (typ)	45ns
V_F (max)	2.0V

FEATURES AND BENEFITS

- SPECIFIC TO THE FOLLOWING OPERATIONS: SNUBBING OR CLAMPING, DEMAGNETIZATION AND RECTIFICATION
- ULTRA-FAST, SOFT RECOVERY.
- VERY LOW OVERALL POWER LOSSES IN BOTH THE DIODE AND THE COMPANION TRANSISTOR.
- HIGH FREQUENCY AND/OR HIGH PULSED CURRENT OPERATION.
- HIGH REVERSE VOLTAGE CAPABILITY
- INSULATED PACKAGE : ISOWATT220AC
Electrical insulation : 2000V DC
Capacitance : 12pF.

DESCRIPTION

TURBOSWITCH 1200V drastically cuts losses in all high voltage operations which require extremely fast, soft and noise-free power diodes. Due to their optimized switching performances they also highly decrease power losses in any associated switching IGBT or MOSFET in all "freewheel mode" operations.

ABSOLUTE RATINGS (limiting values)

Symbol	Parameter		Value	Unit
V_{RRM}	Repetitive peak reverse voltage		1200	V
V_{RSM}	Non repetitive peak reverse voltage		1200	V
$I_{F(RMS)}$	RMS forward current	TO-220AC / DPAK	20	A
		ISOWATT220AC	10	A
I_{FRM}	Repetitive peak forward current	$t_p = 5 \mu s$ F = 5kHz square	70	A
I_{FSM}	Surge non repetitive forward current	$t_p = 10ms$ sinusoidal	45	A
T_{stg}	Storage temperature range		- 65 to + 150	°C
T_j	Maximum operating junction temperature		150	°C

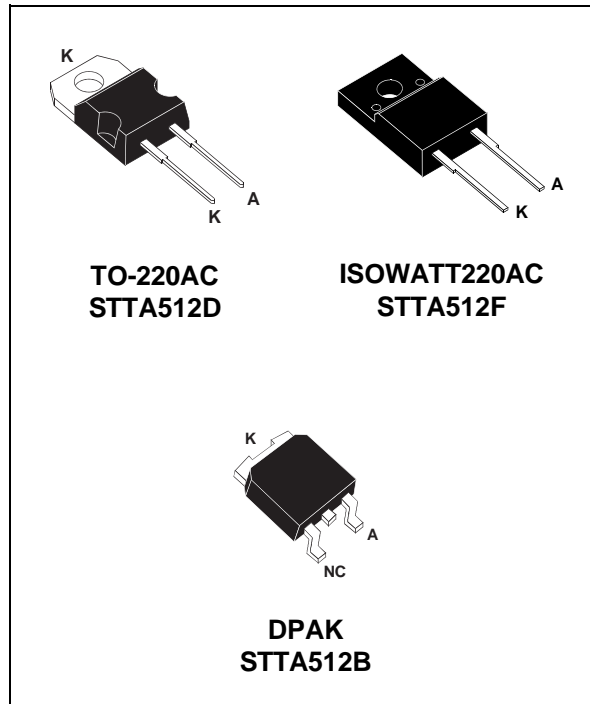

They are particularly suitable in motor control circuitries, or in the primary of SMPS as snubber, clamping or demagnetizing diodes. They are also suitable for secondary of SMPS as high voltage rectifier diodes.

STTA512D/F/B

THERMAL AND POWER DATA

Symbol	Parameter	Conditions	Value	Unit
$R_{th(j-c)}$	Junction to case thermal resistance	TO-220AC/DPAK ISOWATT220AC	4.0 5.5	°C/W
P_1	Conduction power dissipation $I_{F(AV)} = 5A$ $\delta = 0.5$	TO-220AC/DPAK ISOWATT220AC	$T_c = 102^\circ C$ $T_c = 84^\circ C$	W
P_{max}	Total power dissipation $P_{max} = P_1 + P_3$ ($P_3 = 10\% P_1$)	TO-220AC/DPAK ISOWATT220AC	$T_c = 98^\circ C$ $T_c = 78^\circ C$	W

STATIC ELECTRICAL CHARACTERISTICS

Symbol	Parameter	Test conditions	Min	Typ	Max	Unit
V_F^*	Forward voltage drop	$I_F = 5A$ $T_j = 25^\circ C$ $T_j = 125^\circ C$		1.35	2.2 2.0	V V
I_R^{**}	Reverse leakage current	$V_R = 0.8 \times V_{RRM}$ $T_j = 25^\circ C$ $T_j = 125^\circ C$		0.3	100 2.0	μA mA
V_{to}	Threshold voltage	$I_p < 3 \cdot I_{AV}$ $T_j = 125^\circ C$			1.57	V
R_d	Dynamic resistance				86	m Ω

Test pulses : * $t_p = 380 \mu s$, $\delta < 2\%$

** $t_p = 5 ms$, $\delta < 2\%$

To evaluate the maximum conduction losses use the following equation :

$$P = V_{to} \times I_{F(AV)} + r_d \times I_F^2 (RMS)$$

DYNAMIC ELECTRICAL CHARACTERISTICS

TURN-OFF SWITCHING

Symbol	Parameter	Test conditions	Min	Typ	Max	Unit
t_{rr}	Reverse recovery time	$T_j = 25^\circ C$ $I_F = 0.5 A$ $I_R = 1A$ $I_{rr} = 0.25A$ $I_F = 1 A$ $di_F/dt = -50A/\mu s$ $V_R = 30V$		45	95	ns
I_{RM}	Maximum reverse recovery current	$T_j = 125^\circ C$ $V_R = 600V$ $I_F = 5A$ $di_F/dt = -40 A/\mu s$ $di_F/dt = -500 A/\mu s$		20	7.5	A
S factor	Softness factor	$T_j = 125^\circ C$ $V_R = 600V$ $I_F = 5A$ $di_F/dt = -500 A/\mu s$		1.2		/

TURN-ON SWITCHING

Symbol	Parameter	Test conditions	Min	Typ	Max	Unit
t_{fr}	Forward recovery time	$T_j = 25^\circ C$ $I_F = 5 A$, $di_F/dt = 40 A/\mu s$ measured at $1.1 \times V_{Fmax}$			900	ns
V_{Fp}	Peak forward voltage	$T_j = 25^\circ C$ $I_F = 5A$, $di_F/dt = 40 A/\mu s$ $I_F = 40A$, $di_F/dt = 500 A/\mu s$		50	35	V

Fig. 1: Conduction losses versus average current.

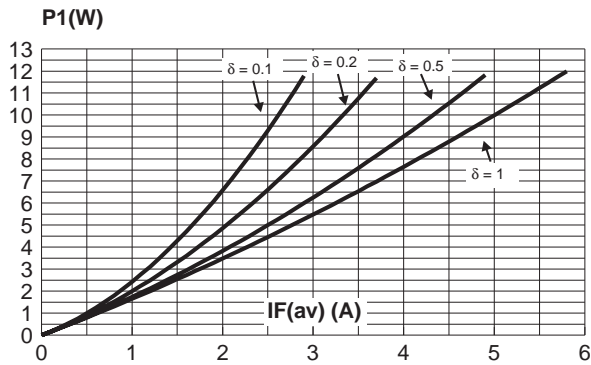

Fig. 1: Forward voltage drop versus forward current (maximum values).

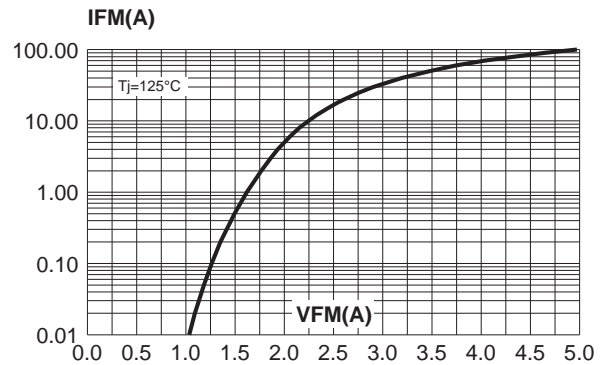

Fig. 3: Peak reverse recovery current versus dI_F/dt (90% confidence).

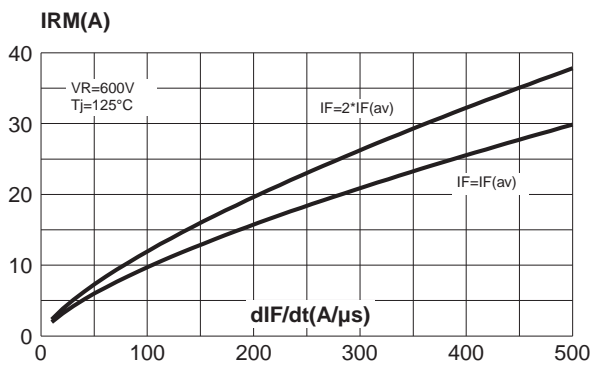

Fig. 4: Relative variation of thermal impedance junction to case versus pulse duration (TO-220AC and DPAK).

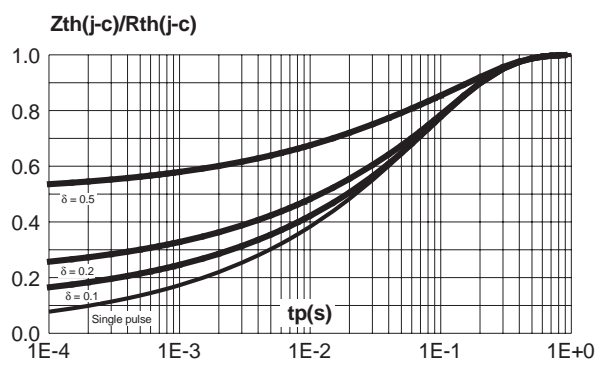

Fig. 5: Relative variation of thermal impedance junction to case versus pulse duration (ISOWATT220AC).

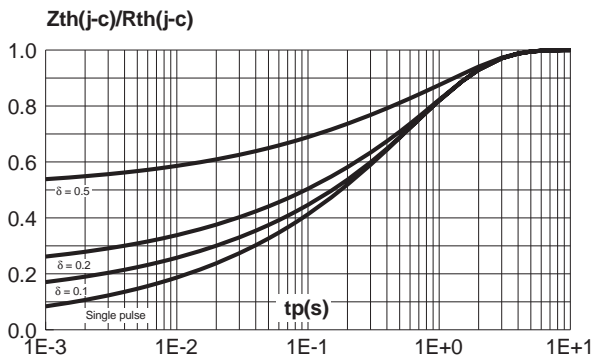

Fig. 6: Reverse recovery time versus dI_F/dt (90% confidence).

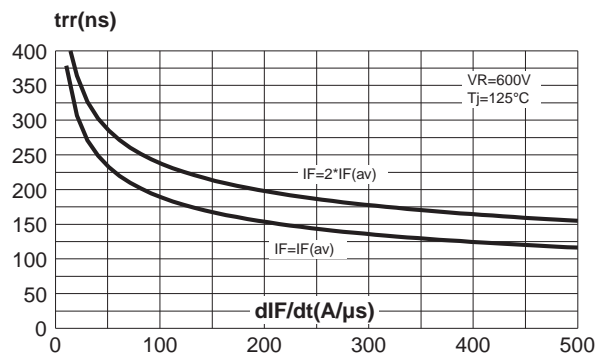

Fig. 7: Softness factor (t_b/t_a) versus dI_F/dt (typical values).

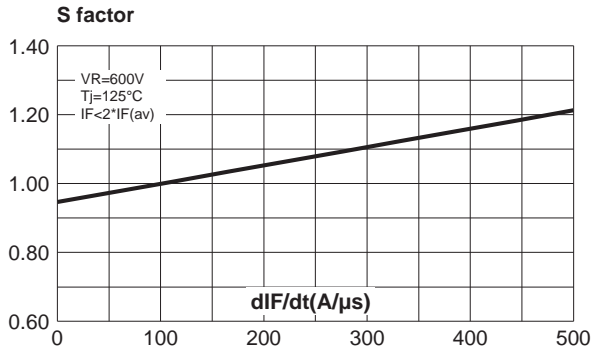

Fig. 8: Relative variation of dynamic parameters versus junction temperature (reference Tj=125°C).

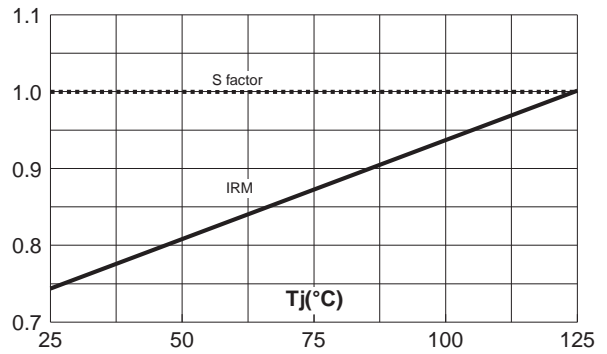

Fig. 9: Transient peak forward voltage versus dI_F/dt (90% confidence).

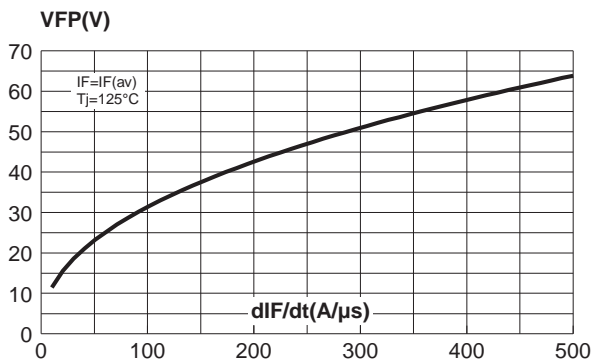
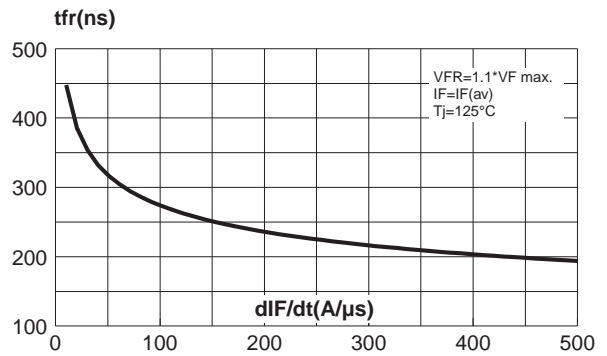

Fig. 10: Forward recovery time versus dI_F/dt (90% confidence).



APPLICATION DATA

The 1200V TURBOSWITCH series has been designed to provide the lowest overall power losses in all high frequency or high pulsed current operations. In such applications (Fig A to D), the way of calculating the power losses is given below :

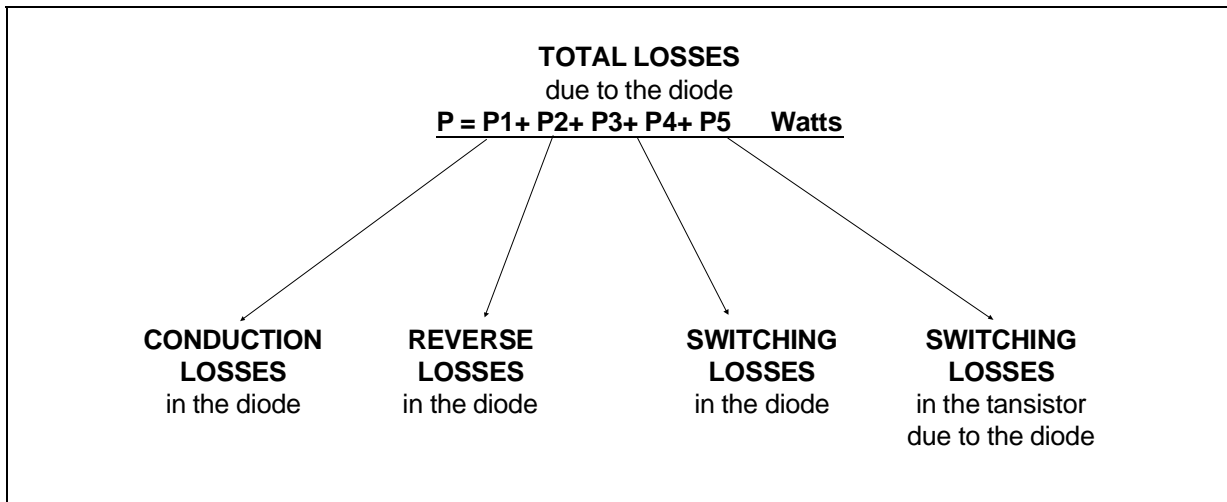

Fig. A : "FREEWHEEL" MODE.

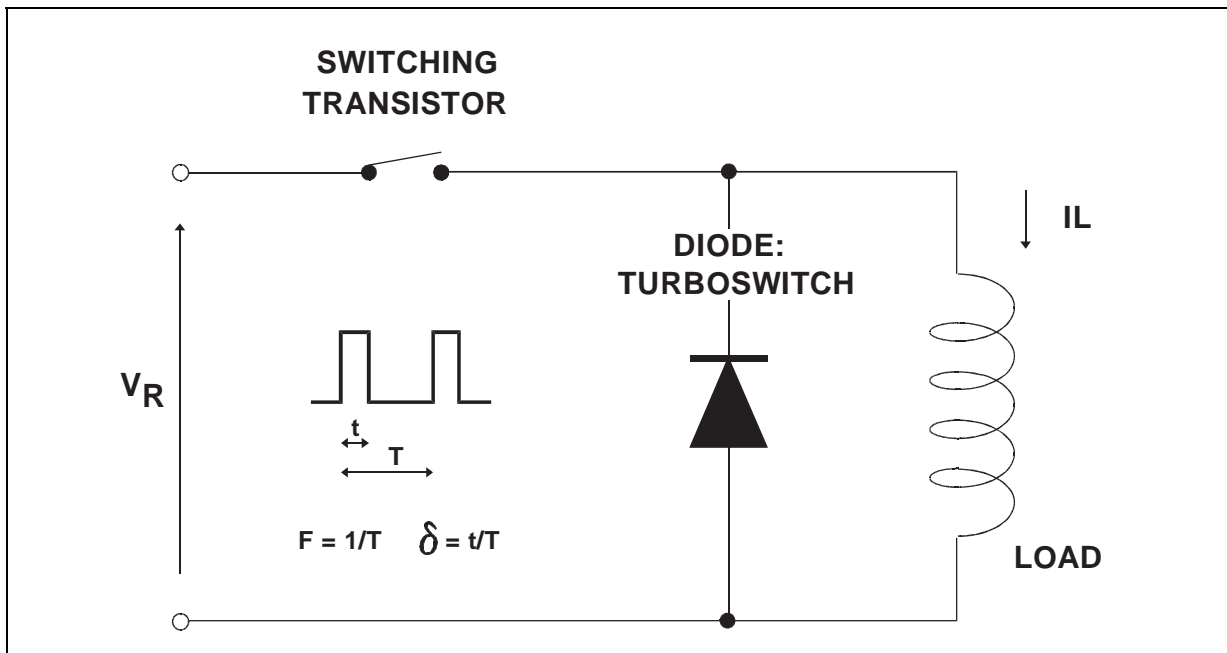

Fig. B : SNUBBER DIODE.

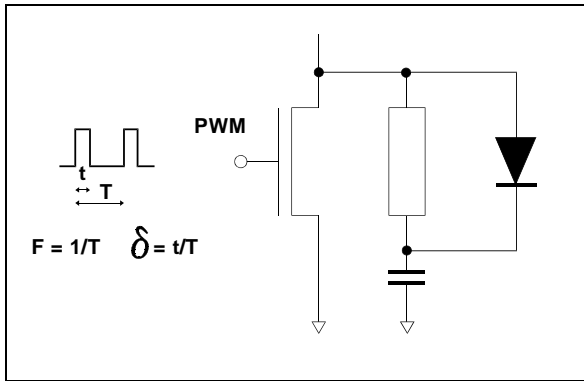

Fig. C : DEMAGNETIZING DIODE.

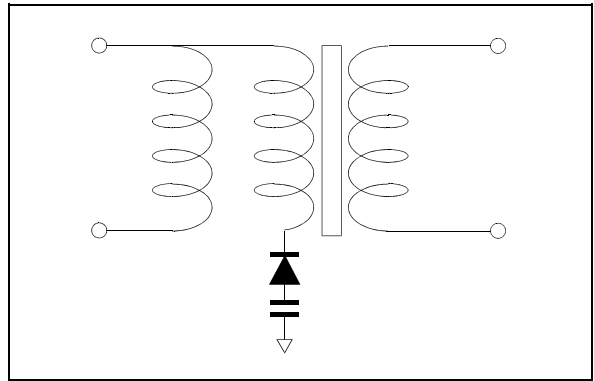
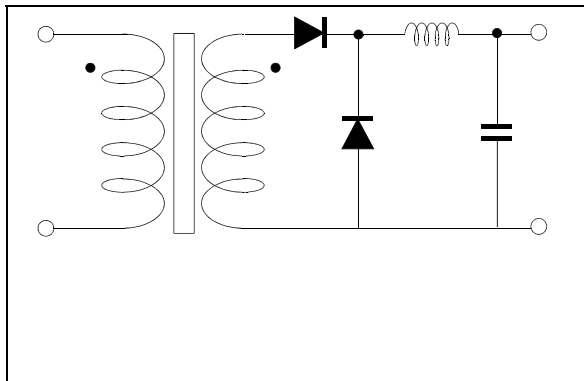
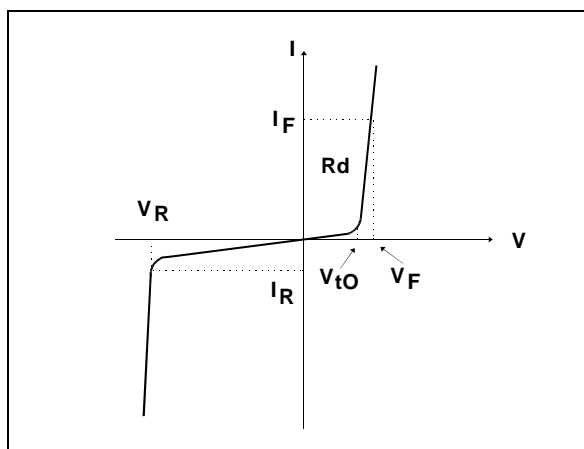

Fig. D : RECTIFIER DIODE.



STATIC & DYNAMIC CHARACTERISTICS . POWER LOSSES .

Fig. E: STATIC CHARACTERISTICS



Conduction losses :

$$P1 = V_{t0} \cdot I_F(AV) + R_d \cdot I_F^2(RMS)$$

Reverse losses :

$$P2 = V_R \cdot I_R \cdot (1 - \delta)$$

APPLICATION DATA (Cont'd)

Fig. F: TURN-OFF CHARACTERISTICS

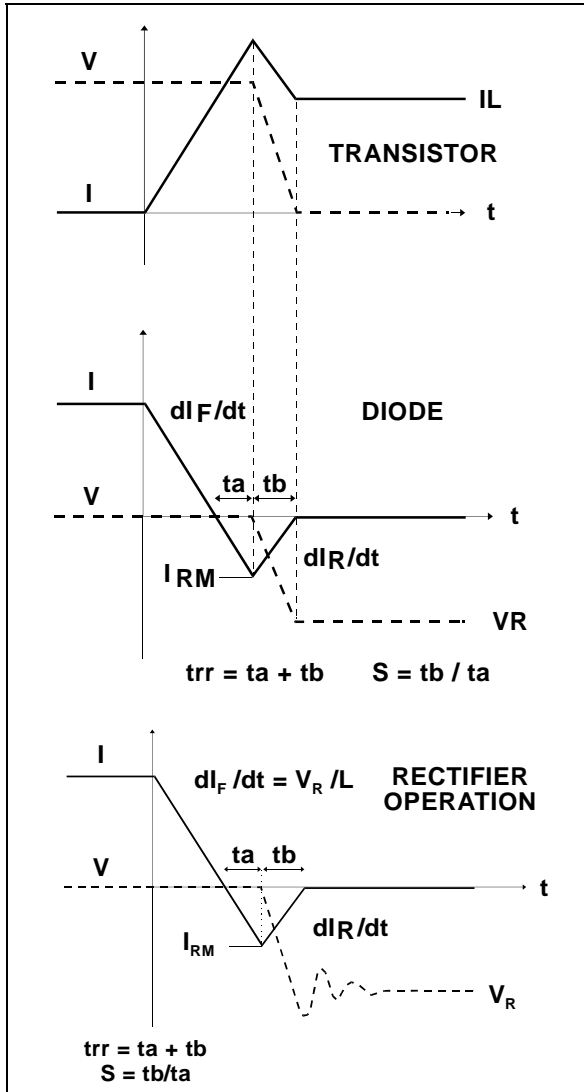

Turn-on losses :
(in the transistor, due to the diode)

$$P5 = \frac{V_R \times I_{RM}^2 \times (3 + 2 \times S) \times F}{6 \times dI_F/dt} + \frac{V_R \times I_{RM} \times I_L \times (S + 2) \times F}{2 \times dI_F/dt}$$

Turn-off losses (in the diode) :

$$P3 = \frac{V_R \times I_{RM}^2 \times S \times F}{6 \times dI_F/dt}$$

Turn-off losses :
(with non negligible serial inductance)

$$P3' = \frac{V_R \times I_{RM}^2 \times S \times F}{6 \times dI_F/dt} + \frac{L \times I_{RM}^2 \times F}{2}$$

P3,P3' and P5 are suitable for power MOSFET and IGBT

Fig. G: TURN-ON CHARACTERISTICS

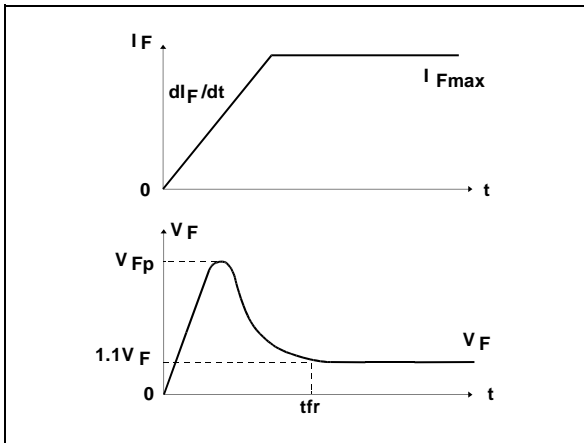

Turn-on losses :
 $P4 = 0.4 (V_{FP} - V_F) \cdot I_{Fmax} \cdot t_{fr} \cdot F$

STTA512D/F/B

PACKAGE DATA DPAK

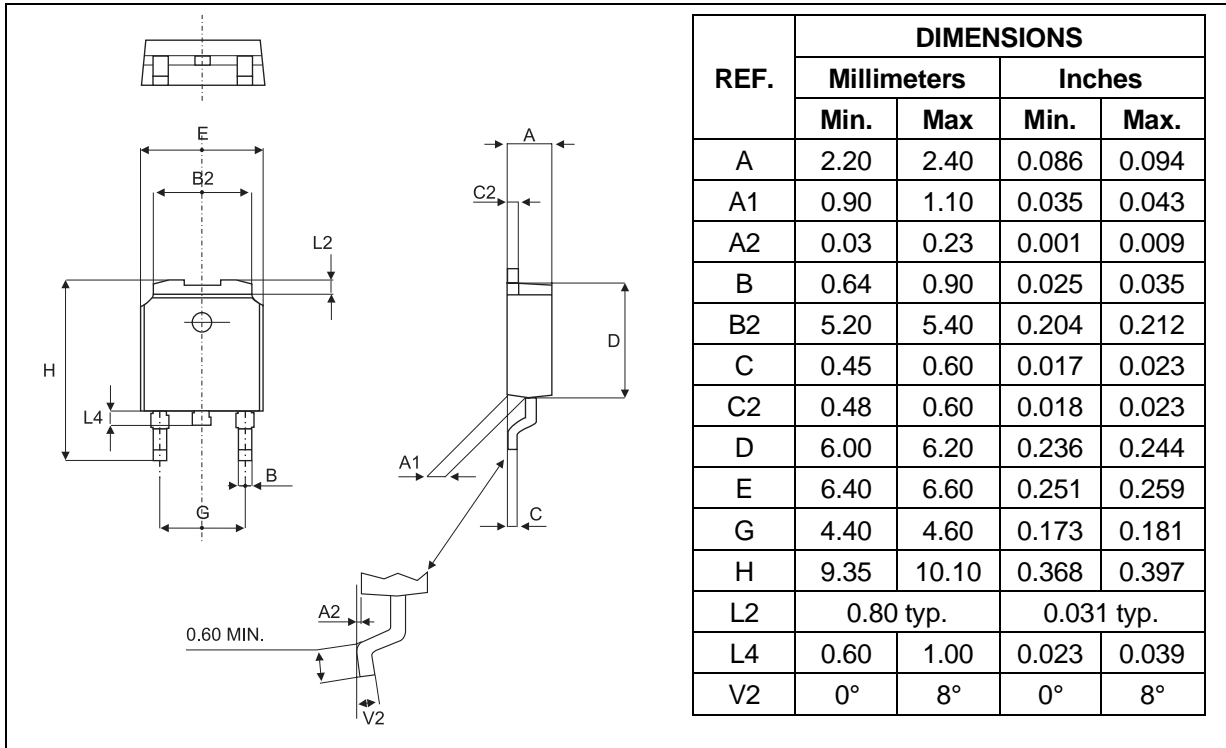

FOOTPRINT DIMENSIONS (in millimeters)

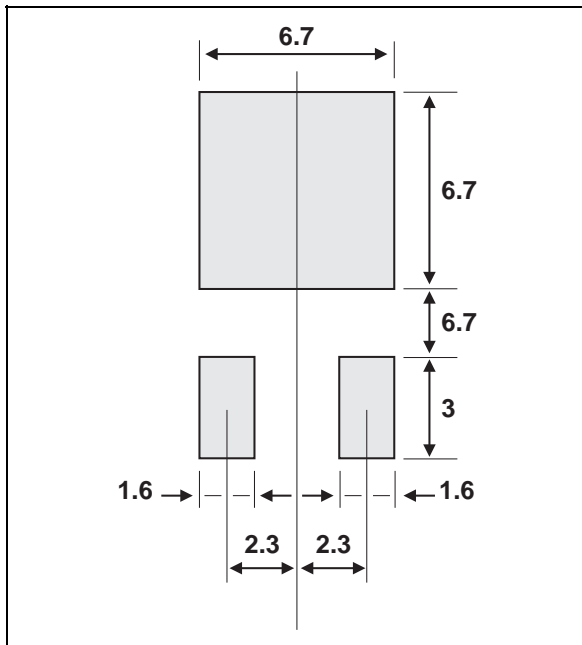

PACKAGE DATA
ISOWATT220AC

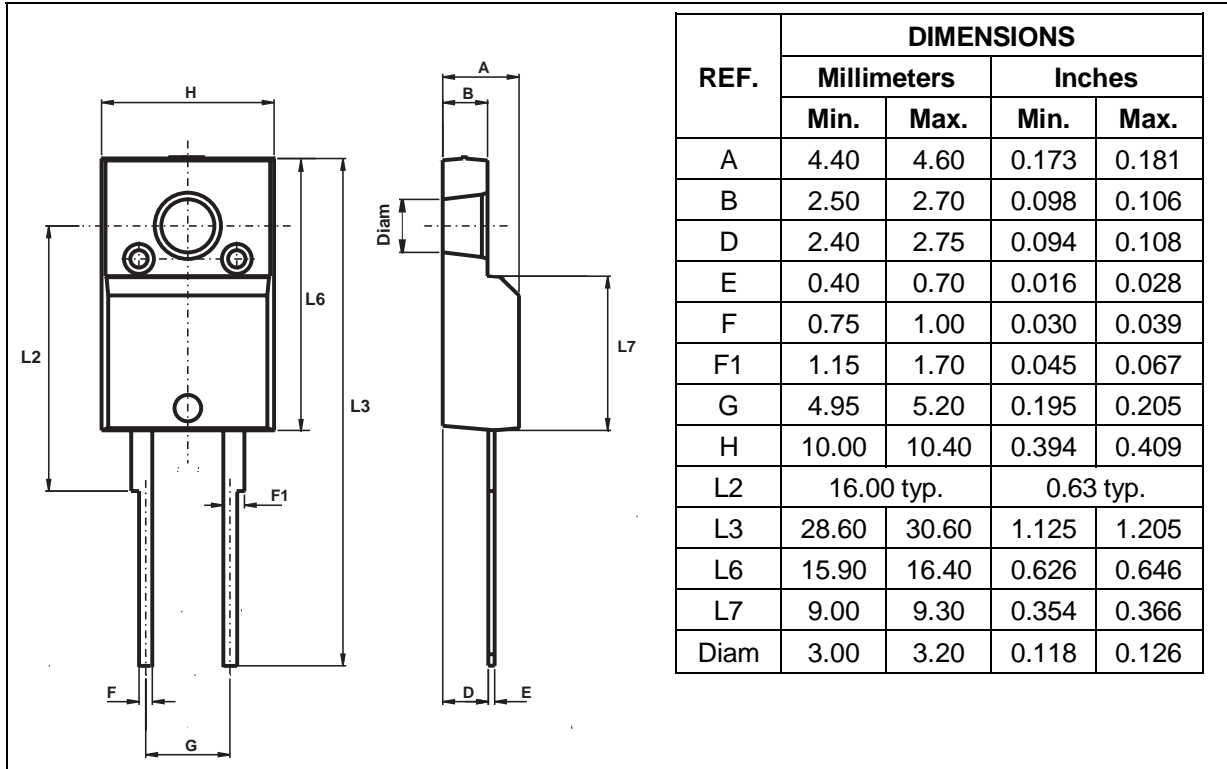

- Cooling method: by conduction (C)
- Recommended torque value: 0.55 m.N
- Maximum torque value: 0.7 m.N

STTA512D/F/B

PACKAGE DATA

TO-220AC (JEDEC outline)

REF.	DIMENSIONS			
	Millimeters		Inches	
	Min.	Max.	Min.	Max.
A	4.40	4.60	0.173	0.181
C	1.23	1.32	0.048	0.051
D	2.40	2.72	0.094	0.107
E	0.49	0.70	0.019	0.027
F	0.61	0.88	0.024	0.034
F1	1.14	1.70	0.044	0.066
G	4.95	5.15	0.194	0.202
H2	10.00	10.40	0.393	0.409
L2	16.40 typ.		0.645 typ.	
L4	13.00	14.00	0.511	0.551
L5	2.65	2.95	0.104	0.116
L6	15.25	15.75	0.600	0.620
L7	6.20	6.60	0.244	0.259
L9	3.50	3.93	0.137	0.154
M	2.6 typ.		0.102 typ.	
Diam. I	3.75	3.85	0.147	0.151

- Cooling method: by conduction (C)
- Recommended torque value: 0.55 m.N
- Maximum torque value: 0.7 m.N

Ordering type	Marking	Package	Weight	Base qty	Delivery mode
STTA512D	STTA512D	TO-220AC	1.86g	50	Tube
STTA512F	STTA512F	ISOWATT220AC	2g	50	Tube
STTA512B	A512	DPAK	0.3g	75	Tube
STTA512B-TR	A512	DPAK	0.3g	2500	Tape & reel

- Epoxy meets UL94,V0

Information furnished is believed to be accurate and reliable. However, STMicroelectronics assumes no responsibility for the consequences of use of such information nor for any infringement of patents or other rights of third parties which may result from its use. No license is granted by implication or otherwise under any patent or patent rights of STMicroelectronics. Specifications mentioned in this publication are subject to change without notice. This publication supersedes and replaces all information previously supplied.

STMicroelectronics products are not authorized for use as critical components in life support devices or systems without express written approval of STMicroelectronics.

The ST logo is a registered trademark of STMicroelectronics

© 1999 STMicroelectronics - Printed in Italy - All rights reserved.

STMicroelectronics GROUP OF COMPANIES

Australia - Brazil - China - Finland - France - Germany - Hong Kong - India - Italy - Japan - Malaysia
Malta - Morocco - Singapore - Spain - Sweden - Switzerland - United Kingdom - U.S.A.

<http://www.st.com>

This datasheet has been download from:

www.datasheetcatalog.com

Datasheets for electronics components.