

# DS90C385A +3.3V Programmable LVDS Transmitter 24-Bit Flat Panel Display Link-87.5 MHz

## General Description

The DS90C385A is a pin to pin compatible replacement for DS90C383, DS90C383A and DS90C385. The DS90C385A has additional features and improvements making it an ideal replacement for DS90C383, DS90C383A and DS90C385. family of LVDS Transmitters.

The DS90C385A transmitter converts 28 bits of LVCMOS/LVTTL data into four LVDS (Low Voltage Differential Signaling) data streams. A phase-locked transmit clock is transmitted in parallel with the data streams over the fifth LVDS link. Every cycle of the transmit clock 28 bits of input data are sampled and transmitted. At a transmit clock frequency of 87.5 MHz, 24 bits of RGB data and 3 bits of LCD timing and control data (FPLINE, FPFRAME, DRDY) are transmitted at a rate of 612.5Mbps per LVDS data channel. Using a 87.5 MHz clock, the data throughput is 306.25Mbytes/sec. This transmitter can be programmed for Rising edge strobe or Falling edge strobe through a dedicated pin. A Rising edge or Falling edge strobe transmitter will interoperate with a Falling edge strobe FPDLink Receiver without any translation logic.

This chipset is an ideal means to solve EMI and cable size problems associated with wide, high-speed TTL interfaces with added Spread Spectrum Clocking support.

## Features

- Pin-to-pin compatible to DS90C383, DS90C383A and DS90C385 .
- No special start-up sequence required between clock/data and /PD pins. Input signals (clock and data) can be applied either before or after the device is powered.
- Support Spread Spectrum Clocking up to 100kHz frequency modulation & deviations of  $\pm 2.5\%$  center spread or  $-5\%$  down spread.
- "Input Clock Detection" feature will pull all LVDS pairs to logic low when input clock is missing and when /PD pin is logic high.
- 18 to 87.5 MHz shift clock support
- Tx power consumption < 147 mW (typ) @ 87.5 MHz Grayscale
- Tx Power-down mode < 60  $\mu$ W (typ)
- Supports VGA, SVGA, XGA, SXGA(dual pixel), SXGA+(dual pixel), UXGA(dual pixel).
- Narrow bus reduces cable size and cost
- Up to 2.45 Gbps throughput
- Up to 306.25Megabytes/sec bandwidth
- 345 mV (typ) swing LVDS devices for low EMI
- PLL requires no external components
- Compliant to TIA/EIA-644 LVDS standard
- Low profile 56-lead TSSOP package

## Block Diagram

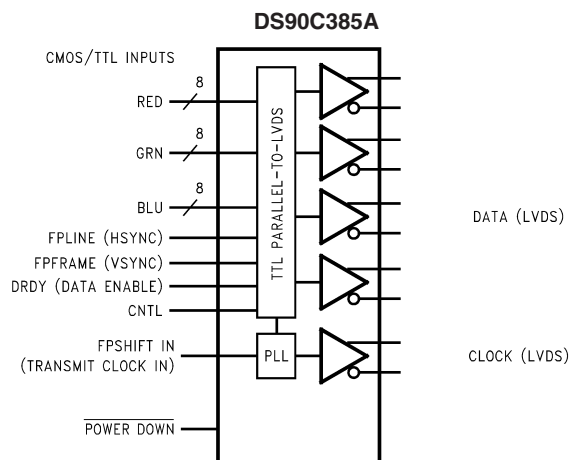

Order Number DS90C385AMT  
See NS Package Number MTD56

20070201

**Absolute Maximum Ratings** (Note 1)

If Military/Aerospace specified devices are required, please contact the National Semiconductor Sales Office/Distributors for availability and specifications.

Supply Voltage ( $V_{CC}$ )	-0.3V to +4V
CMOS/TTL Input Voltage	-0.5V to ( $V_{CC} + 0.3V$ )
LVDS Driver Output Voltage	-0.3V to ( $V_{CC} + 0.3V$ )
LVDS Output Short Circuit Duration	Continuous
Junction Temperature	+150°C
Storage Temperature	-65°C to +150°C
Lead Temperature (Soldering, 4 sec)	+260°C
Maximum Package Power Dissipation Capacity @ 25°C MTD56 (TSSOP)	
Package: DS90C385AMT	1.63 W

Package Derating:

DS90C385AMT 12.5 mW/°C above +25°C

ESD Rating

(HBM, 1.5kΩ, 100pF) 7kV

(EIAJ, 0Ω, 200 pF) 500V

Latch Up Tolerance @ 25°C ±100mA

**Recommended Operating Conditions**

	Min	Nom	Max	Units
Supply Voltage ( $V_{CC}$ )	3.0	3.3	3.6	V
Operating Free Air Temperature ( $T_A$ )	-10	+25	+70	°C
Supply Noise Voltage ( $V_{CC}$ )			200	mV <sub>PP</sub>
TxCLKIN frequency	18		87.5	MHz

**Electrical Characteristics**

Over recommended operating supply and temperature ranges unless otherwise specified.

Symbol	Parameter	Conditions	Min	Typ	Max	Units	
<b>LVCMOS/LVTTL DC SPECIFICATIONS</b>							
$V_{IH}$	High Level Input Voltage		2.0		$V_{CC}$	V	
$V_{IL}$	Low Level Input Voltage		0		0.8	V	
$V_{CL}$	Input Clamp Voltage	$I_{CL} = -18$ mA		-0.79	-1.5	V	
$I_{IN}$	Input Current	$V_{IN} = 0.4V, 2.5V$ or $V_{CC}$		+1.8	+10	μA	
		$V_{IN} = GND$	-10	0		μA	
<b>LVDS DC SPECIFICATIONS</b>							
$V_{OD}$	Differential Output Voltage	$R_L = 100\Omega$	250	345	450	mV	
$\Delta V_{OD}$	Change in $V_{OD}$ between complimentary output states				35	mV	
$V_{OS}$	Offset Voltage (Note 4)		1.13	1.25	1.38	V	
$\Delta V_{OS}$	Change in $V_{OS}$ between complimentary output states				35	mV	
$I_{OS}$	Output Short Circuit Current	$V_{OUT} = 0V, R_L = 100\Omega$		-3.5	-5	mA	
$I_{OZ}$	Output TRI-STATE® Current	Power Down = 0V, $V_{OUT} = 0V$ or $V_{CC}$		±1	±10	μA	
<b>TRANSMITTER SUPPLY CURRENT</b>							
ICCTW	Transmitter Supply Current Worst Case	$R_L = 100\Omega,$ $C_L = 5$ pF, Worst Case Pattern ( <i>Figures 1, 3</i> ) "Typ" values are given for $V_{CC} = 3.6V$ and $T_A = +25^\circ C$ , "Max" values are given for $V_{CC} = 3.6V$ and $T_A = -10^\circ C$	f = 25 MHz		31	45	mA
			f = 40 MHz		37	50	mA
			f = 65 MHz		48	60	mA
			f = 87.5 MHz		55	65	mA

## Electrical Characteristics (Continued)

Over recommended operating supply and temperature ranges unless otherwise specified.

Symbol	Parameter	Conditions	Min	Typ	Max	Units	
<b>TRANSMITTER SUPPLY CURRENT</b>							
ICCTG	Transmitter Supply Current 16 Grayscale	$R_L = 100\Omega$ , $C_L = 5\text{ pF}$ , 16 Grayscale Pattern (Figures 2, 3) "Typ" values are given for $V_{CC} = 3.6\text{V}$ and $T_A = +25^\circ\text{C}$ , "Max" values are given for $V_{CC} = 3.6\text{V}$ and $T_A = -10^\circ\text{C}$	$f = 25\text{ MHz}$		29	40	mA
			$f = 40\text{ MHz}$		33	45	mA
			$f = 65\text{ MHz}$		39	50	mA
			$f = 87.5\text{ MHz}$		44	55	mA
ICCTZ	Transmitter Supply Current Power Down	Power Down = Low Driver Outputs in TRI-STATE under Power Down Mode		17	150	$\mu\text{A}$	

**Note 1:** "Absolute Maximum Ratings" are those values beyond which the safety of the device cannot be guaranteed. They are not meant to imply that the device should be operated at these limits. The tables of "Electrical Characteristics" specify conditions for device operation.

**Note 2:** Typical values are given for  $V_{CC} = 3.3\text{V}$  and  $T_A = +25^\circ\text{C}$  unless specified otherwise.

**Note 3:** Current into device pins is defined as positive. Current out of device pins is defined as negative. Voltages are referenced to ground unless otherwise specified (except  $V_{OD}$  and  $\Delta V_{OD}$ ).

**Note 4:**  $V_{OS}$  previously referred as  $V_{CM}$ .

## Recommended Transmitter Input Characteristics

Over recommended operating supply and temperature ranges unless otherwise specified

Symbol	Parameter	Min	Typ	Max	Units
TCIT	TxCLK IN Transition Time (Figure 5)	1.0		6.0	ns
TCIP	TxCLK IN Period (Figure 6)	11.42	T	55.55	ns
TCIH	TxCLK IN High Time (Figure 6)	0.35T	0.5T	0.65T	ns
TCIL	TxCLK IN Low Time (Figure 6)	0.35T	0.5T	0.65T	ns
TXIT	TxIN, and PWR DOWN pin Transition Time	1.5		6.0	ns
TXPD	Minimum pulse width for PWR DOWN pin signal.	1			us

## Transmitter Switching Characteristics

Over recommended operating supply and temperature ranges unless otherwise specified

Symbol	Parameter	Min	Typ	Max	Units	
LLHT	LVDS Low-to-High Transition Time (Figure 4)		0.75	1.4	ns	
LHLT	LVDS High-to-Low Transition Time (Figure 4)		0.75	1.4	ns	
TPPos0	Transmitter Output Pulse Position (Figure 12) (Note 5)	$f = 25\text{MHz}$	-0.45	0	+0.45	ns
TPPos1	Transmitter Output Pulse Position		5.26	5.71	6.16	ns
TPPos2	Transmitter Output Pulse Position		10.98	11.43	11.88	ns
TPPos3	Transmitter Output Pulse Position		16.69	17.14	17.59	ns
TPPos4	Transmitter Output Pulse Position		22.41	22.86	23.31	ns
TPPos5	Transmitter Output Pulse Position		28.12	28.57	29.02	ns
TPPos6	Transmitter Output Pulse Position		33.84	34.29	34.74	ns

## Transmitter Switching Characteristics (Continued)

Over recommended operating supply and temperature ranges unless otherwise specified

Symbol	Parameter		Min	Typ	Max	Units
TPPos0	Transmitter Output Pulse Position ( <i>Figure 12</i> ) (Note 5)	f = 40 MHz	-0.25	0	+0.25	ns
TPPos1	Transmitter Output Pulse Position		3.32	3.57	3.82	ns
TPPos2	Transmitter Output Pulse Position		6.89	7.14	7.39	ns
TPPos3	Transmitter Output Pulse Position		10.46	10.71	10.96	ns
TPPos4	Transmitter Output Pulse Position		14.04	14.29	14.54	ns
TPPos5	Transmitter Output Pulse Position		17.61	17.86	18.11	ns
TPPos6	Transmitter Output Pulse Position		21.18	21.43	21.68	ns
TPPos0	Transmitter Output Pulse Position ( <i>Figure 12</i> ) (Note 5)	f = 65 MHz	-0.20	0	+0.20	ns
TPPos1	Transmitter Output Pulse Position		2.00	2.20	2.40	ns
TPPos2	Transmitter Output Pulse Position for Bit 2		4.20	4.40	4.60	ns
TPPos3	Transmitter Output Pulse Position for Bit 3		6.39	6.59	6.79	ns
TPPos4	Transmitter Output Pulse Position		8.59	8.79	8.99	ns
TPPos5	Transmitter Output Pulse Position		10.79	10.99	11.19	ns
TPPos6	Transmitter Output Pulse Position		12.99	13.19	13.39	ns
TPPos0	Transmitter Output Pulse Position ( <i>Figure 12</i> ) (Note 5)	f = 87.5 MHz	-0.20	0	+0.20	ns
TPPos1	Transmitter Output Pulse Position		1.48	1.68	1.88	ns
TPPos2	Transmitter Output Pulse Position		3.16	3.36	3.56	ns
TPPos3	Transmitter Output Pulse Position		4.84	5.04	5.24	ns
TPPos4	Transmitter Output Pulse Position		6.52	6.72	6.92	ns
TPPos5	Transmitter Output Pulse Position		8.20	8.40	8.60	ns
TPPos6	Transmitter Output Pulse Position		9.88	10.08	10.28	ns
TSTC	Required TxIN Setup to TxCLK IN ( <i>Figure 6</i> ) at 85MHz		2.5			ns
THTC	Required TxIN Hold to TxCLK IN ( <i>Figure 6</i> ) at 87.5 MHz		0.5			ns
TCCD	TxCLK IN to TxCLK OUT Delay. Measure from TxCLK IN edge to immediately crossing point of differential TxCLK OUT by following the positive TxCLK OUT. 50% duty cycle input clock is assumed. ( <i>Figure 7</i> )	T <sub>A</sub> = -10°, and 87.5MHz for " Min ", T <sub>A</sub> = 70°, and 25MHz for " Max ", V <sub>CC</sub> = 3.6V, R <sub>FB</sub> pin = VCC	3.086		7.211	ns
	Measure from TxCLK IN edge to immediately crossing point of differential TxCLK OUT by following the positive TxCLK OUT. 50% duty cycle input clock is assumed. ( <i>Figure 8</i> )	T <sub>A</sub> = -10°, and 87.5MHz for " Min ", T <sub>A</sub> = 70°, and 25MHz for " Max ", V <sub>CC</sub> = 3.6V, R <sub>FB</sub> pin = GND	2.868		6.062	ns

## Transmitter Switching Characteristics (Continued)

Over recommended operating supply and temperature ranges unless otherwise specified

Symbol	Parameter	Min	Typ	Max	Units
SSCG	Spread Spectrum Clock support; Modulation frequency with a linear profile.(Note 6)	f = 25 MHz	100kHz ± 2.5%/-5%		
		f = 40 MHz	100kHz ± 2.5%/-5%		
		f = 65 MHz	100kHz ± 2.5%/-5%		
		f = 87.5 MHz	100kHz ± 2.5%/-5%		
TPLLS	Transmitter Phase Lock Loop Set ( <i>Figure 9</i> )			10	ms
TPDD	Transmitter Power Down Delay ( <i>Figure 11</i> )			100	ns

**Note 5:** The Minimum and Maximum Limits are based on statistical analysis of the device performance over process, voltage, and temperature ranges. This parameter is functionality tested only on Automatic Test Equipment (ATE).

**Note 6:** Care must be taken to ensure TSTC and THTC are met so input data are sampling correctly. This SSCG parameter only shows the performance of tracking Spread Spectrum Clock applied to TxCLK IN pin, and reflects the result on TxCLKOUT+ and TxCLKOUT- pins.

# AC Timing Diagrams

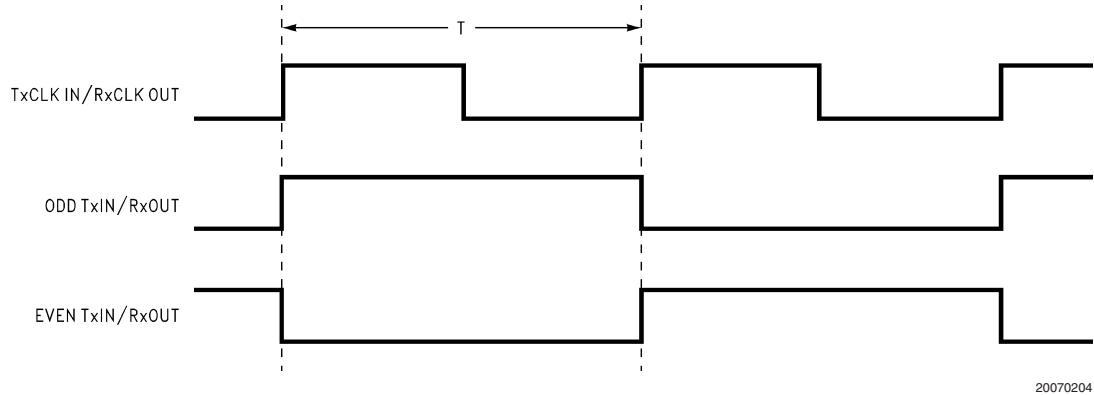

20070204

FIGURE 1. "Worst Case" Test Pattern (Note 7)

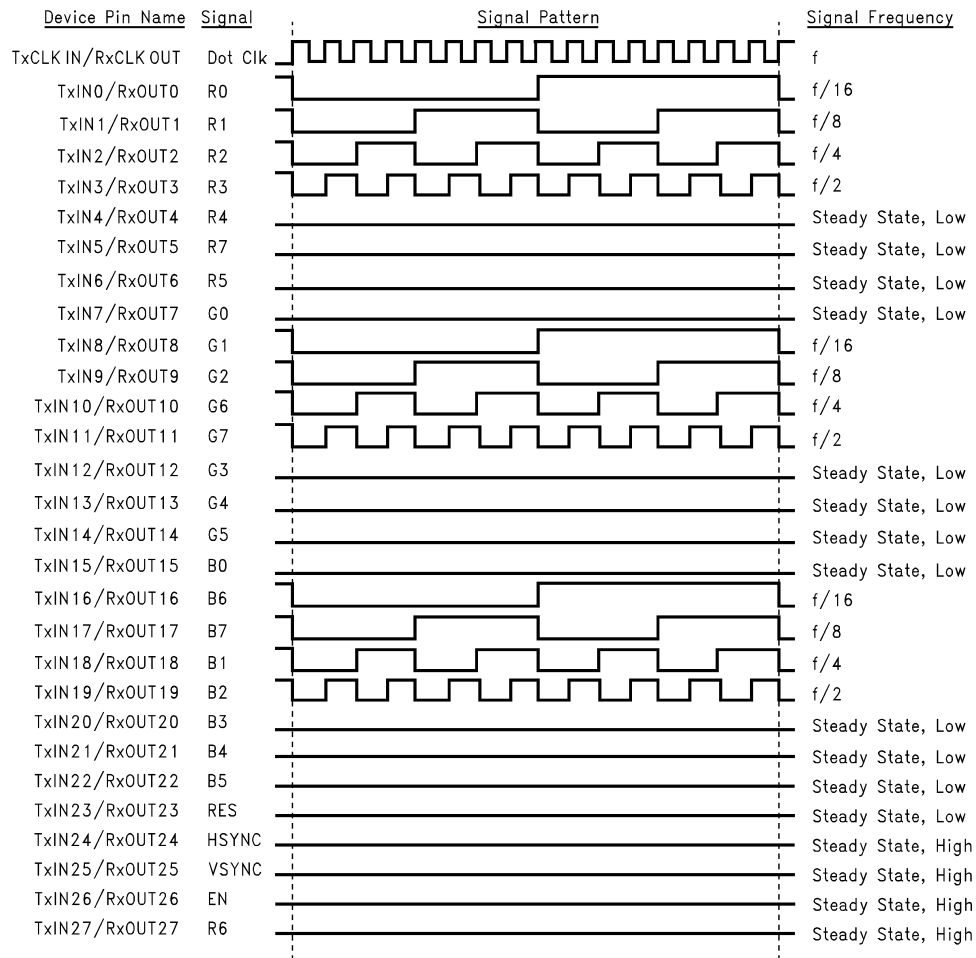

20070205

FIGURE 2. "16 Grayscale" Test Pattern - DS90C385A (Notes 8, 9, 10)

**Note 7:** The worst case test pattern produces a maximum toggling of digital circuits, LVDS I/O and LVCMOS/LVTTL I/O.

**Note 8:** The 16 grayscale test pattern tests device power consumption for a "typical" LCD display pattern. The test pattern approximates signal switching needed to produce groups of 16 vertical stripes across the display.

**Note 9:** Figures 1, 2 show a falling edge data strobe (TxCLK IN/RxCLK OUT).

**Note 10:** Recommended pin to signal mapping. Customer may choose to define differently.

AC Timing Diagrams (Continued)

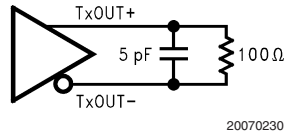

FIGURE 3. DS90C385A (Transmitter) LVDS Output Load. 5pF is shown as board loading

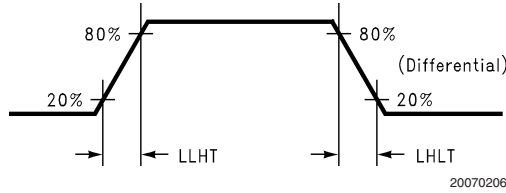

FIGURE 4. DS90C385A (Transmitter) LVDS Transition Times

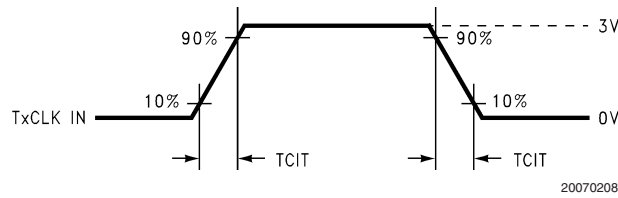

FIGURE 5. DS90C385A (Transmitter) Input Clock Transition Time

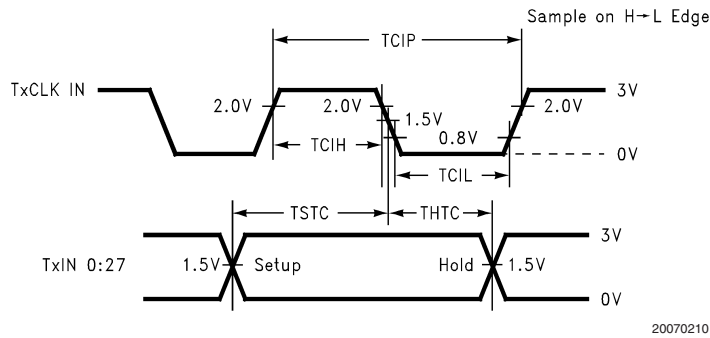

FIGURE 6. DS90C385A (Transmitter) Setup/Hold and High/Low Times with R\_FB pin = GND (Falling Edge Strobe)

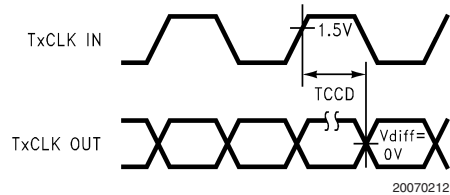

FIGURE 7. DS90C385A (Transmitter) Clock In to Clock Out Delay with R\_FB pin = VCC

AC Timing Diagrams (Continued)

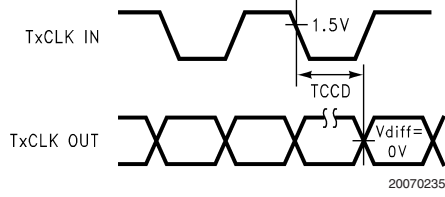

FIGURE 8. DS90C385A (Transmitter) Clock In to Clock Out Delay with R\_FB pin = GND

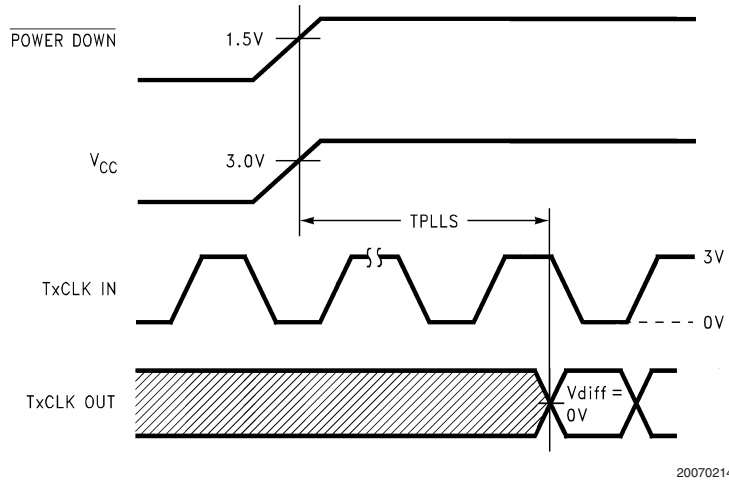

FIGURE 9. DS90C385A (Transmitter) Phase Lock Loop Set Time

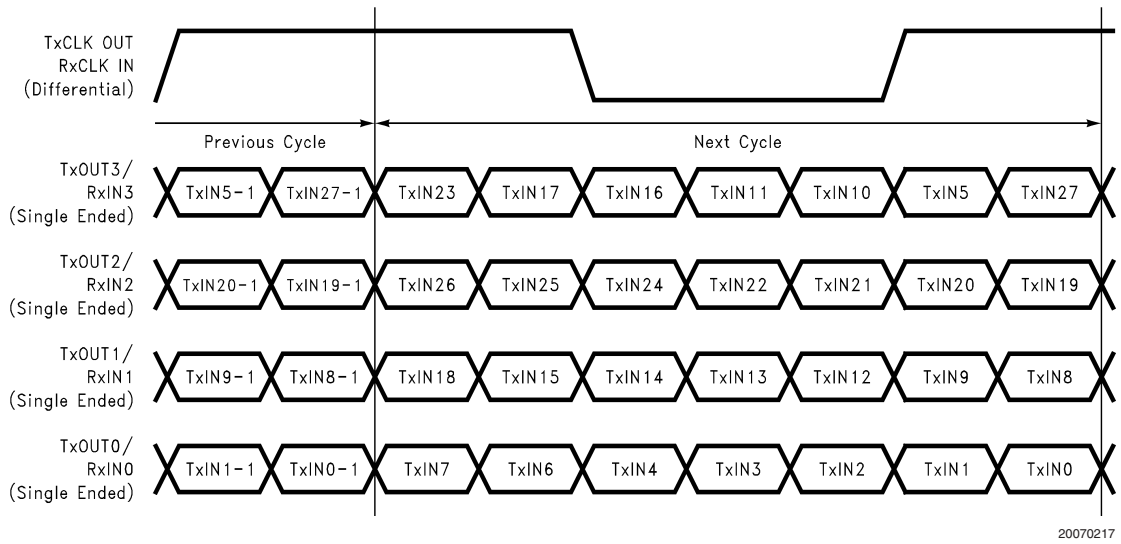

FIGURE 10. 28 Parallel TTL Data Inputs Mapped to LVDS Outputs - DS90C385A



AC Timing Diagrams (Continued)

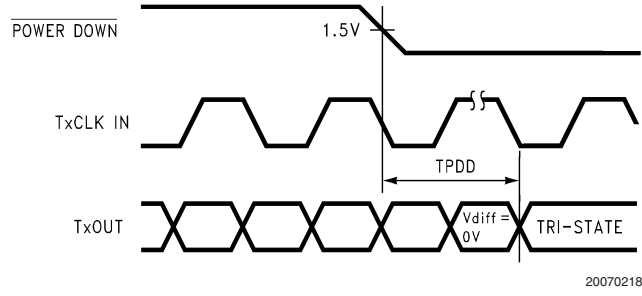

FIGURE 11. Transmitter Power Down Delay

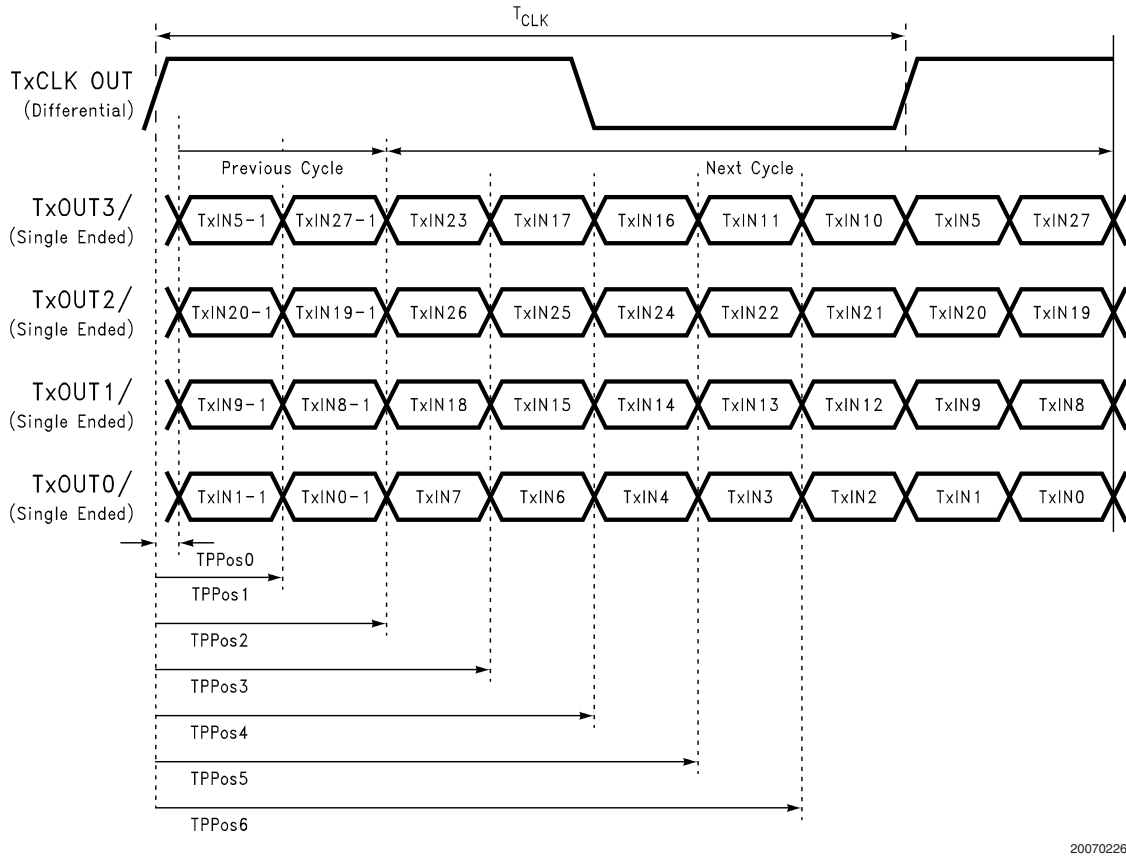

FIGURE 12. Transmitter LVDS Output Pulse Position Measurement - DS90C385A

## DS90C385A MTD56 (TSSOP) Package Pin Descriptions — FPD Link Transmitter

Pin Name	I/O	No.	Description
TxIN	I	28	LVTTTL level input. This includes: 8 Red, 8 Green, 8 Blue, and 4 control lines—FPLINE, FPFRAME and DRDY (also referred to as HSYNC, VSYNC, Data Enable).
TxOUT+	O	4	Positive LVDS differential data output.
TxOUT-	O	4	Negative LVDS differential data output.
TxCLKIN	I	1	LVTTTL level clock input. Pin name TxCLK IN.
R_FB	I	1	LVTTTL level programmable strobe select (See Table 1).
TxCLK OUT+	O	1	Positive LVDS differential clock output.
TxCLK OUT-	O	1	Negative LVDS differential clock output.
PWR DOWN	I	1	LVTTTL level input. When asserted (low input) TRI-STATE the outputs, ensuring low current at power down.
V <sub>CC</sub>	I	3	Power supply pins for LVTTTL inputs.
GND	I	5	Ground pins for LVTTTL inputs.
PLL V <sub>CC</sub>	I	1	Power supply pin for PLL.
PLL GND	I	2	Ground pins for PLL.
LVDS V <sub>CC</sub>	I	1	Power supply pin for LVDS outputs.
LVDS GND	I	3	Ground pins for LVDS outputs.

## Applications Information

The DS90C385A is backward compatible with the DS90C385, DS90C383A, DS90C383 in TSSOP 56-lead package, and it is a pin-for-pin replacements.

This device DS90C385A also features reduced variation of the TCCD parameter which is important for dual pixel applications. (See AN-1084)

This device may also be used as a replacement for the DS90CF583 (5V, 65MHz) and DS90CF581 (5V, 40MHz) FPD-Link Transmitters with certain considerations/modifications:

1. Change 5V power supply to 3.3V. Provide this 3.3V supply to the  $V_{CC}$ , LVDS  $V_{CC}$  and PLL  $V_{CC}$  of the transmitter.
2. The DS90C385A transmitter input and control inputs accept 3.3V LVTTTL/LVCMOS levels. They are not 5V tolerant.
3. To implement a falling edge device for the DS90C385A, the R\_FB pin may be tied to ground OR left unconnected (an internal pull-down resistor biases this pin low). Biasing this pin to  $V_{CC}$  implements a rising edge device.

### TRANSMITTER INPUT PINS

The TxIN and control input pins are compatible with LVCMOS and LVTTTL levels. These pins are not 5V tolerant.

### TRANSMITTER INPUT CLOCK/DATA SEQUENCING

Unlike the DS90C385, DS90C(F)383A/363A, the DS90C385A does not require any special requirement for sequencing of the input clock/data and PD (PowerDown) signal. The DS90C385A offers a more robust input sequenc-

ing feature where the input clock/data can be inserted after the release of the PD signal. In the case where the clock/data is stopped and reapplied, such as changing video mode within Graphics Controller, it is not necessary to cycle the PD signal. However, there are in certain cases where the PD may need to be asserted during these mode changes. In cases where the source (Graphics Source) may be supplying an unstable clock or spurious noisy clock output to the LVDS transmitter, the LVDS Transmitter may attempt to lock onto this unstable clock signal but is unable to do so due the instability or quality of the clock source. The PD signal in these cases should then be asserted once a stable clock is applied to the LVDS transmitter. Asserting the PWR DOWN pin will effectively place the device in reset and disable the PLL, enabling the LVDS Transmitter into a power saving standby mode. However, it is still generally a good practice to assert the PWR DOWN pin or reset the LVDS transmitter whenever the clock/data is stopped and reapplied but it is not mandatory for the DS90C385A.

### SPREAD SPECTRUM CLOCK SUPPORT

The DS90C385A can support Spread Spectrum Clocking signal type inputs. The DS90C385A outputs will accurately track Spread Spectrum Clock/Data inputs with modulation frequencies of up to 100kHz (max.)with either center spread of  $\pm 2.5\%$  or down spread  $-5\%$  deviations.

### POWER SOURCES SEQUENCE

In typical applications, it is recommended to have  $V_{CC}$ , LVDS  $V_{CC}$  and PLL  $V_{CC}$  from the same power source with three separate de-coupling bypass capacitor groups. There is no requirement on which  $V_{CC}$  entering the device first.

## Pin Diagram for TSSOP Packages

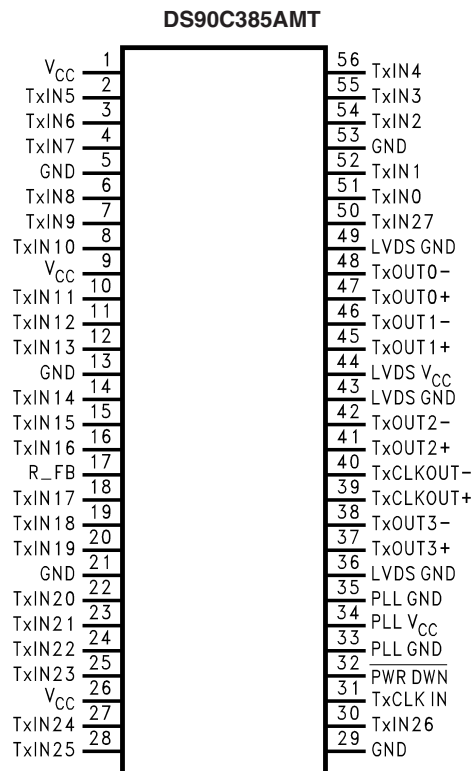

20070223

## Typical Application

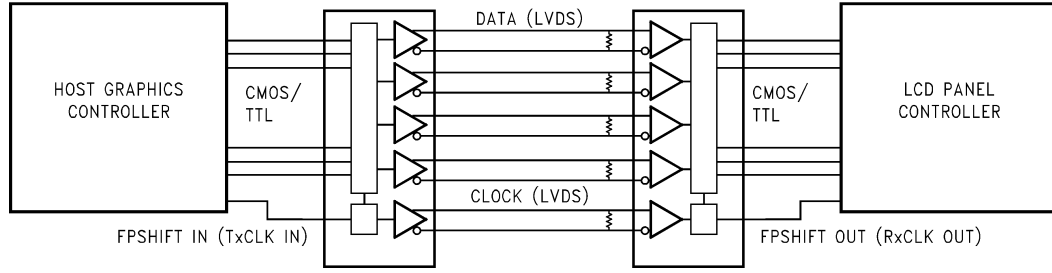

20070203

## Truth Table

**TABLE 1. Programmable Transmitter (DS90C385A)**

Pin	Condition	Strobe Status
R_FB	R_FB = V <sub>CC</sub>	Rising edge strobe
R_FB	R_FB = GND or NC	Falling edge strobe

**Physical Dimensions** inches (millimeters) unless otherwise noted

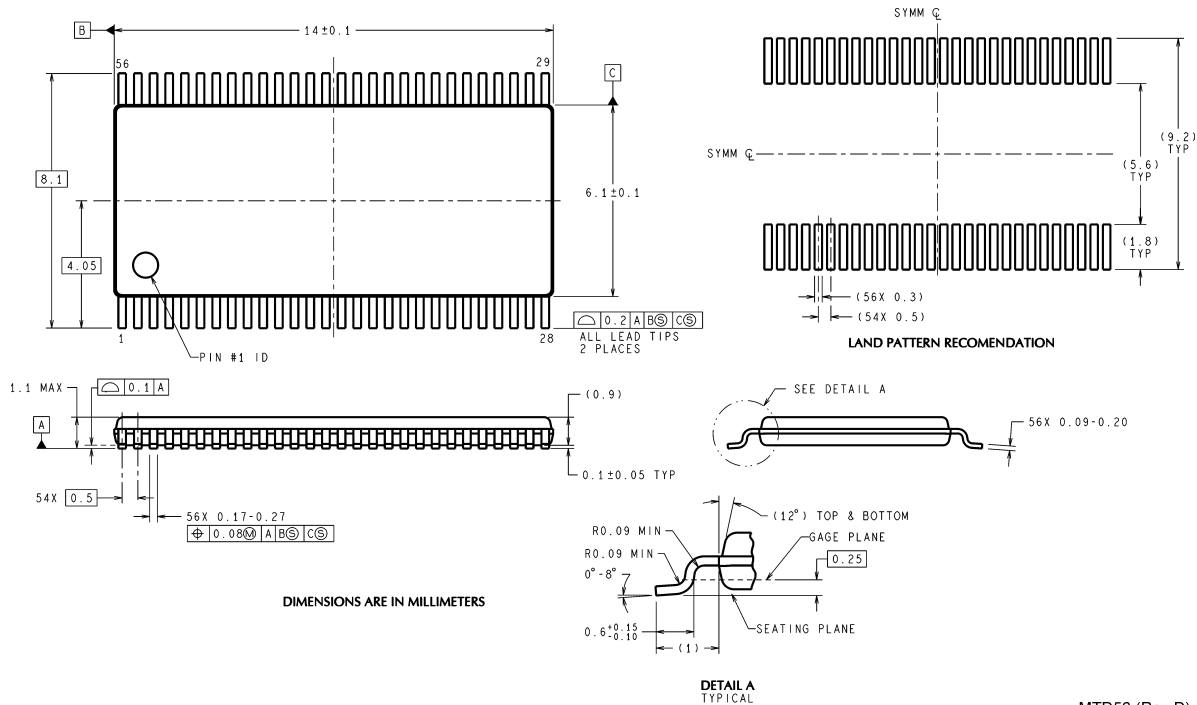

DIMENSIONS ARE IN MILLIMETERS

DETAIL A  
TYPICAL

MTD56 (Rev D)

**56-Lead Molded Thin Shrink Small Outline Package, JEDEC**  
**Dimensions in millimeters only**  
**Order Number DS90C385AMT**  
**NS Package Number MTD56**

National does not assume any responsibility for use of any circuitry described, no circuit patent licenses are implied and National reserves the right at any time without notice to change said circuitry and specifications.

For the most current product information visit us at [www.national.com](http://www.national.com).

**LIFE SUPPORT POLICY**

NATIONAL'S PRODUCTS ARE NOT AUTHORIZED FOR USE AS CRITICAL COMPONENTS IN LIFE SUPPORT DEVICES OR SYSTEMS WITHOUT THE EXPRESS WRITTEN APPROVAL OF THE PRESIDENT AND GENERAL COUNSEL OF NATIONAL SEMICONDUCTOR CORPORATION. As used herein:

1. Life support devices or systems are devices or systems which, (a) are intended for surgical implant into the body, or (b) support or sustain life, and whose failure to perform when properly used in accordance with instructions for use provided in the labeling, can be reasonably expected to result in a significant injury to the user.
2. A critical component is any component of a life support device or system whose failure to perform can be reasonably expected to cause the failure of the life support device or system, or to affect its safety or effectiveness.

**BANNED SUBSTANCE COMPLIANCE**

National Semiconductor manufactures products and uses packing materials that meet the provisions of the Customer Products Stewardship Specification (CSP-9-111C2) and the Banned Substances and Materials of Interest Specification (CSP-9-111S2) and contain no "Banned Substances" as defined in CSP-9-111S2.

Leadfree products are RoHS compliant.



**National Semiconductor**  
**Americas Customer**  
**Support Center**  
 Email: [new.feedback@nsc.com](mailto:new.feedback@nsc.com)  
 Tel: 1-800-272-9959

**National Semiconductor**  
**Europe Customer Support Center**  
 Fax: +49 (0) 180-530 85 86  
 Email: [europe.support@nsc.com](mailto:europe.support@nsc.com)  
 Deutsch Tel: +49 (0) 69 9508 6208  
 English Tel: +44 (0) 870 24 0 2171  
 Français Tel: +33 (0) 1 41 91 8790

**National Semiconductor**  
**Asia Pacific Customer**  
**Support Center**  
 Email: [ap.support@nsc.com](mailto:ap.support@nsc.com)

**National Semiconductor**  
**Japan Customer Support Center**  
 Fax: 81-3-5639-7507  
 Email: [jpn.feedback@nsc.com](mailto:jpn.feedback@nsc.com)  
 Tel: 81-3-5639-7560