

ST02D-170

OUTLINE DIMENSIONS

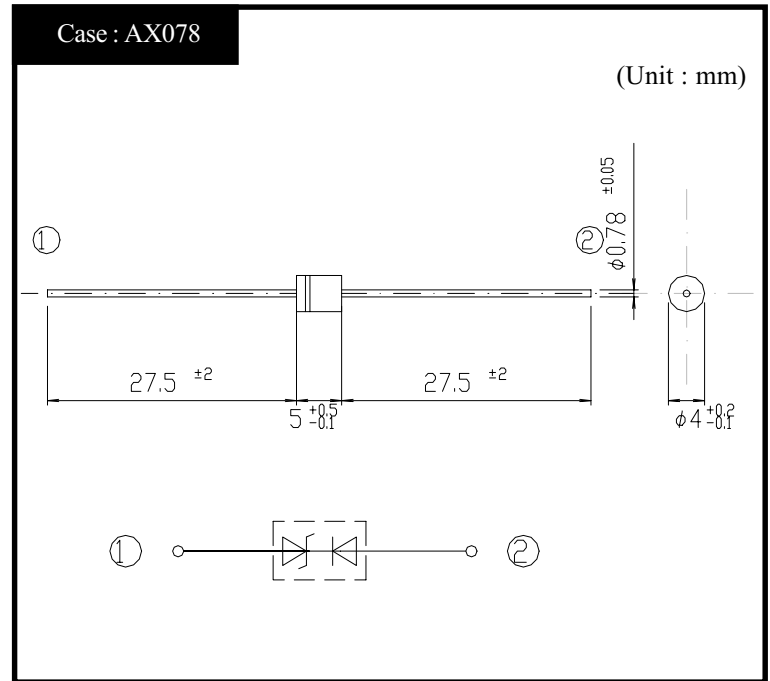

RATINGS

● Absolute Maximum Ratings (Tl=25°C)

Item	Symbol	Conditions	ZD	Di	Unit
Storage Temperature	T _{stg}		-40~150	-40~150	°C
Junction Temperature	T _j		150	150	°C
Peak Surge Reverse Power	P _{RSM}	10/1000 μ s, Non-repetitive	200	-	W
Peak Surge Reverse Current	I _{RSM}	10/1000 μ s, Non-repetitive	0.75	-	A
Maximum Reverse Voltage	V _{RM}		145	600	V

● Electrical Characteristics (Tl=25°C)

Item	Symbol	Conditions	ZD	Di	Unit
Movement Start Voltage	V _{BR}	I _R = 1mA	MIN 155 TYP 170 MAX 185	-	V
Restriction Voltage	V _{GL}	I _{PP} = 0.75A	MAX 280	-	V
Leak Current	I _R	V _R = V _{RM}	MAX 5	MAX 5	μ A
Reverse Recovery Time	t _{rr}	I _F /I _R =0.1A/0.3A	-	MAX 500	ns
Thermal Resistance	θ _{jL}	Junction to lead	MAX 17	MAX 17	°C/W

ST02D-170 Breakdown Voltage

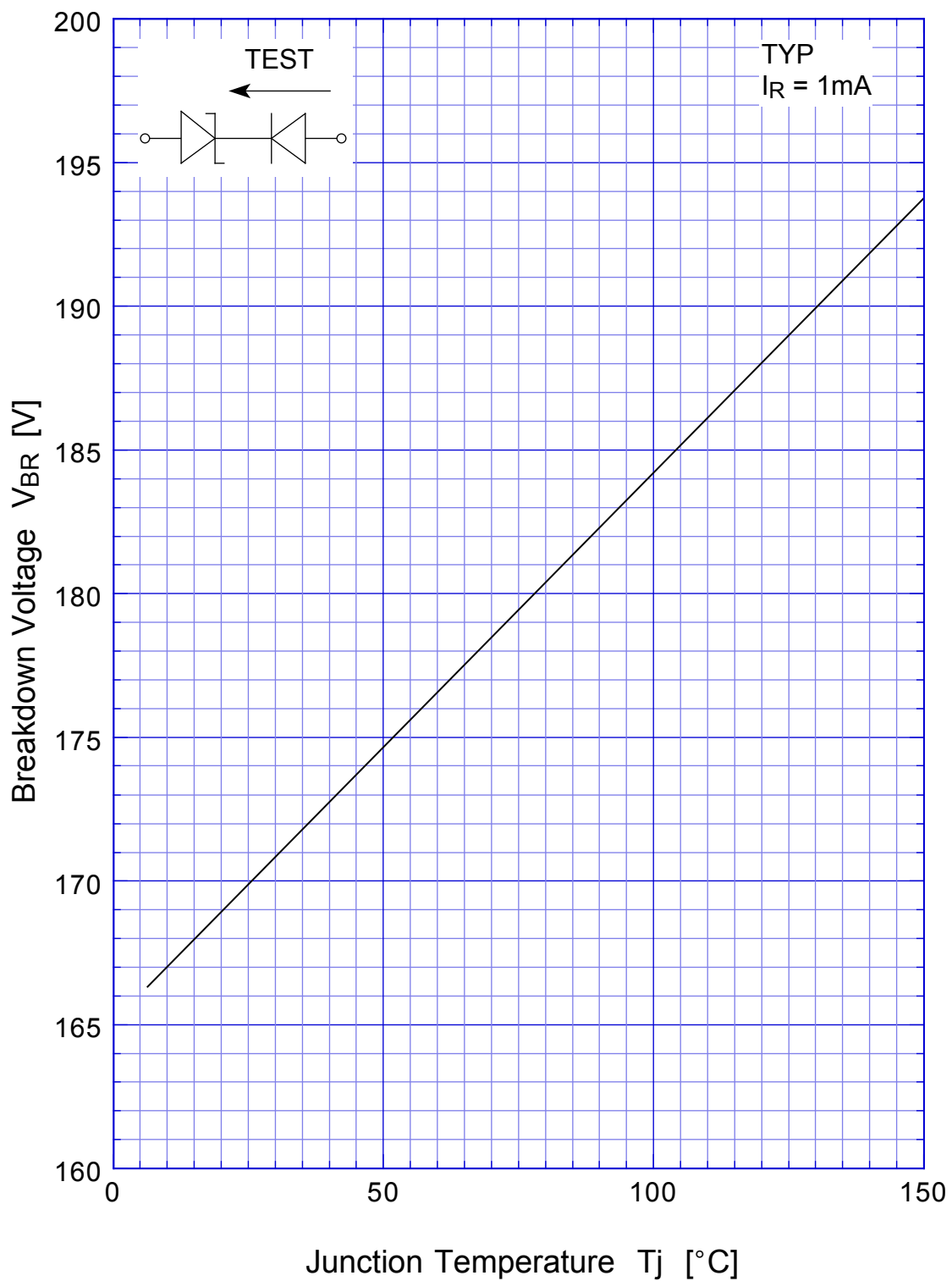

ST02D-170 Reverse Current

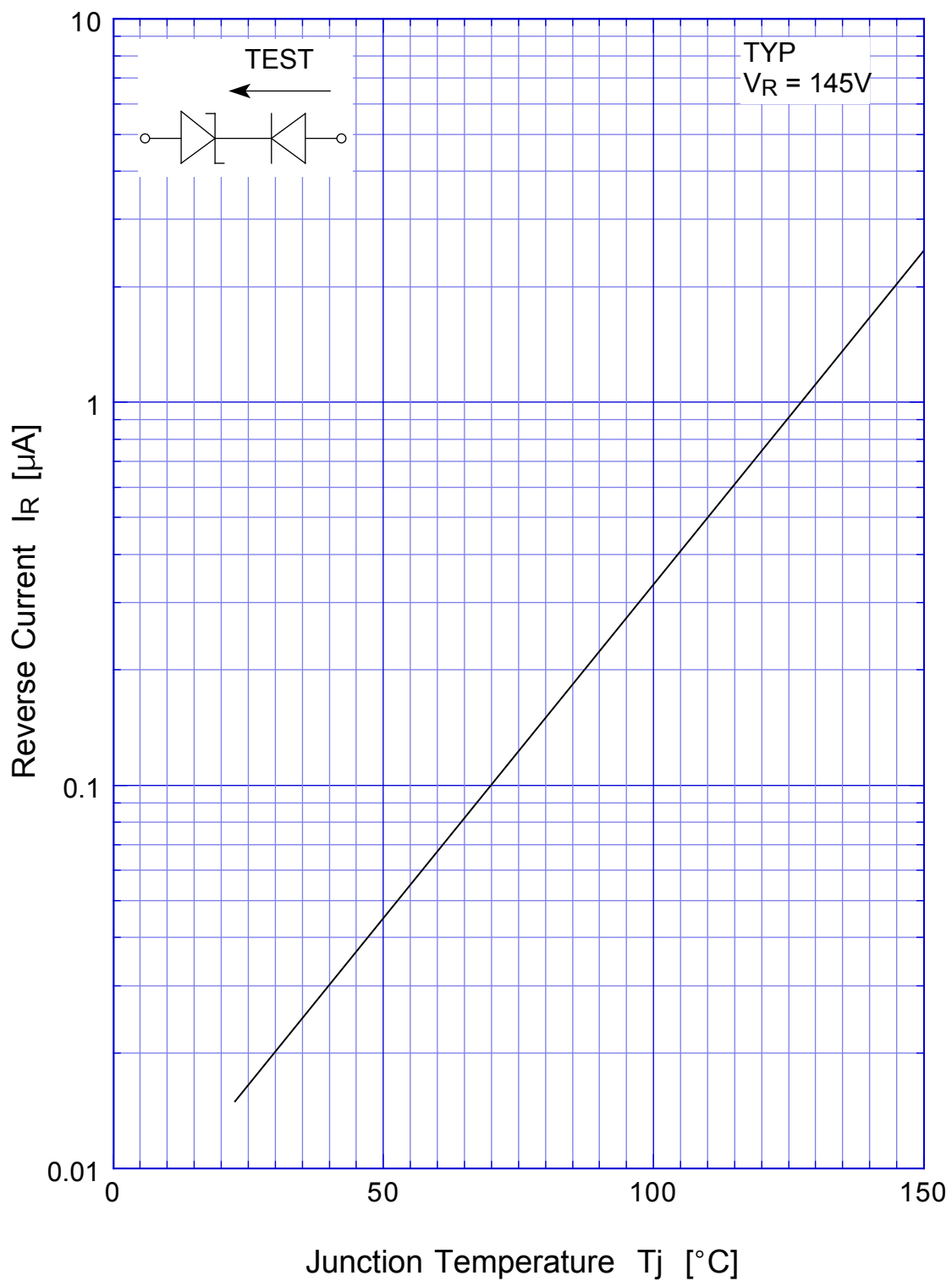

ST02D-170 Reverse Current

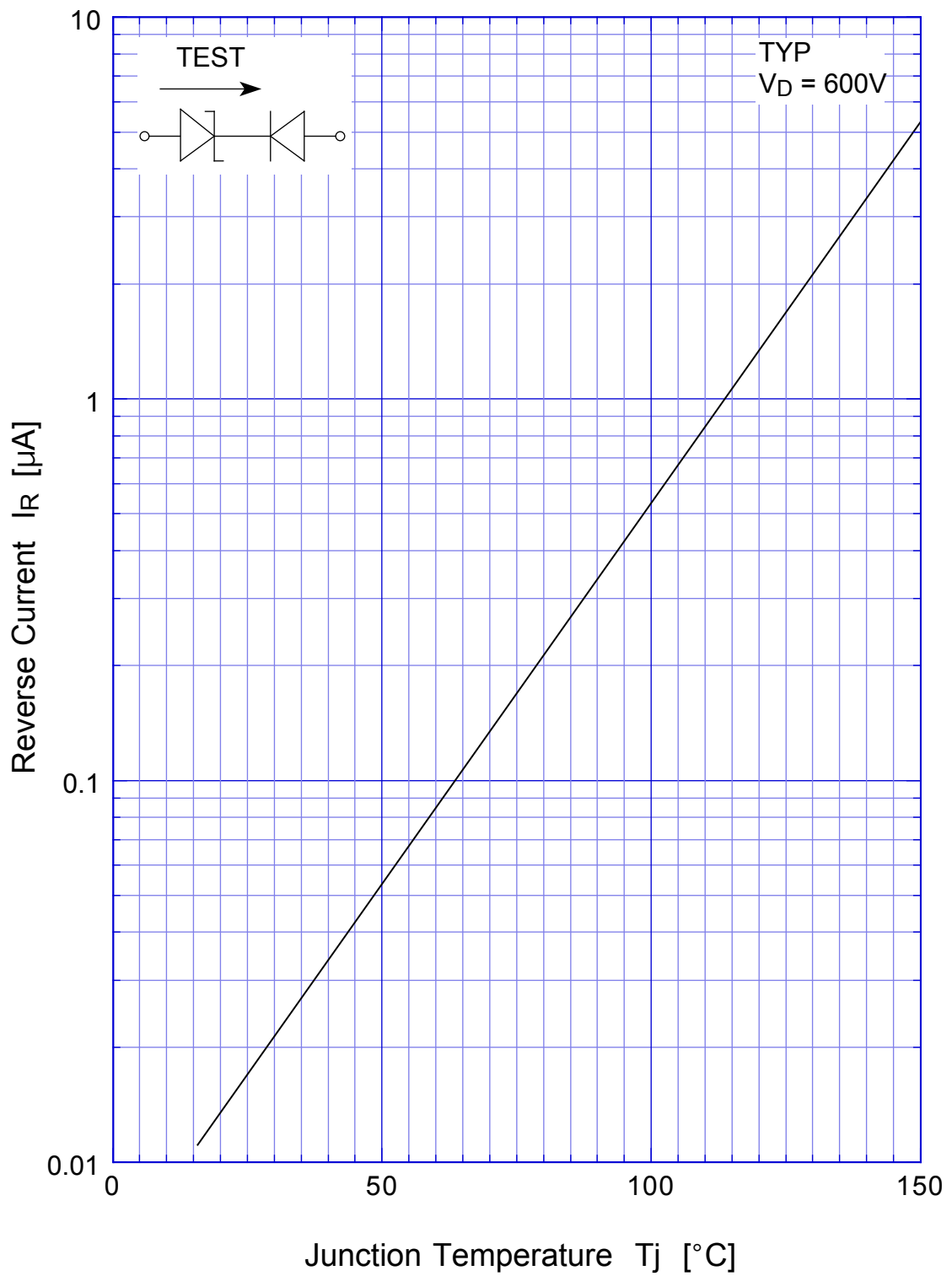

ST02D-170

Peak Surge Reverse Power

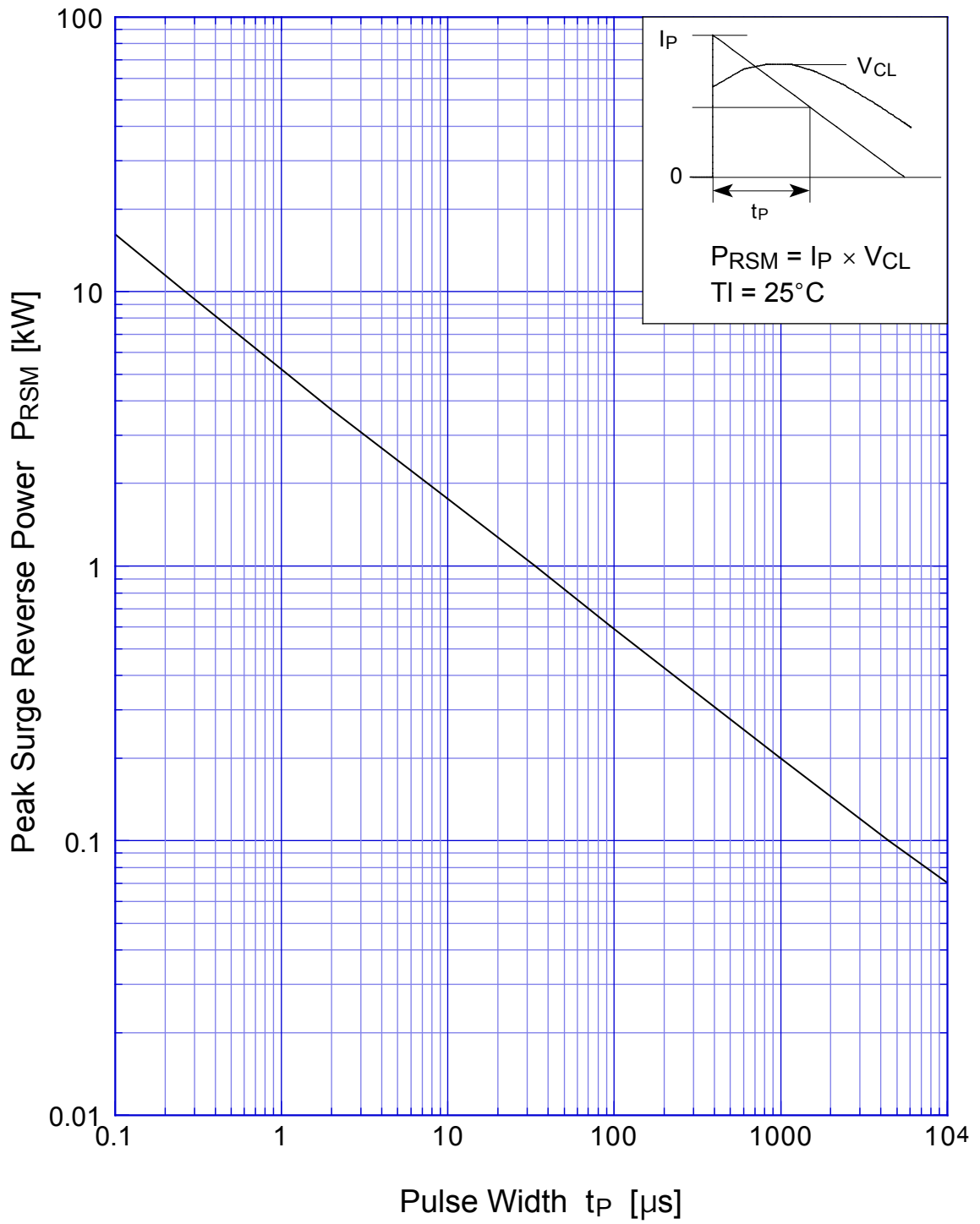

ST02D-170 Junction Capacitance

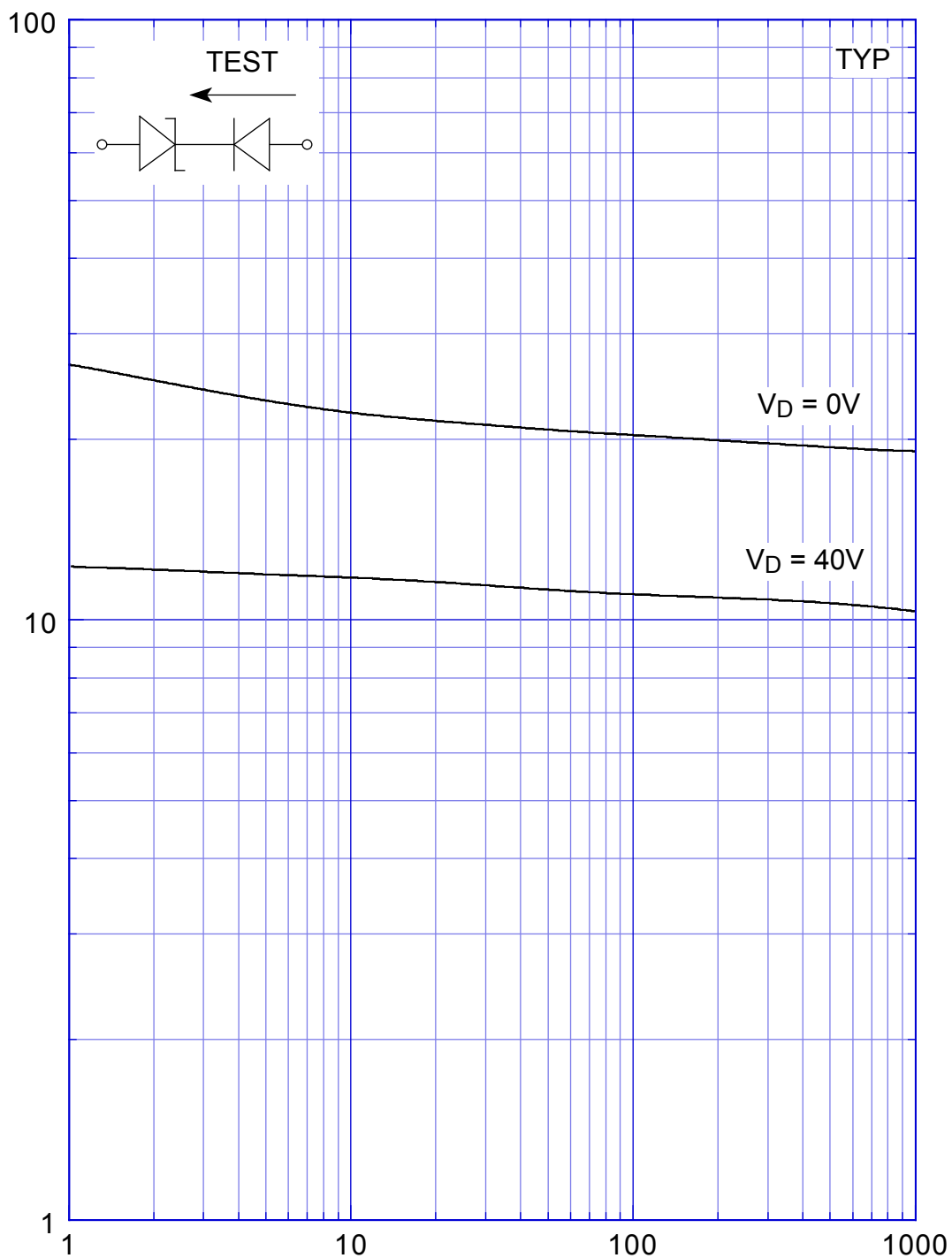

ST02D-170 Junction Capacitance

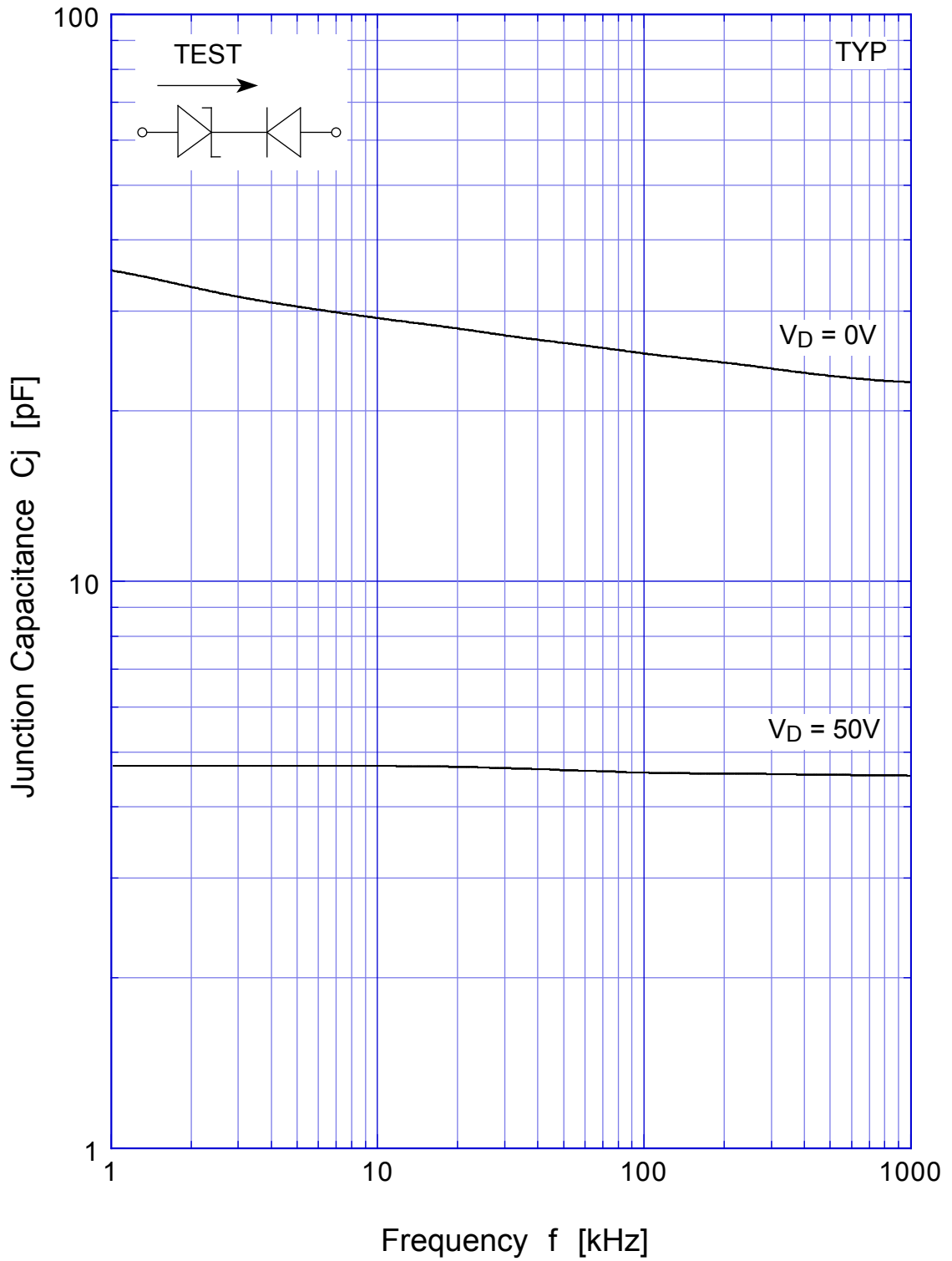

ST02D-170 Junction Capacitance

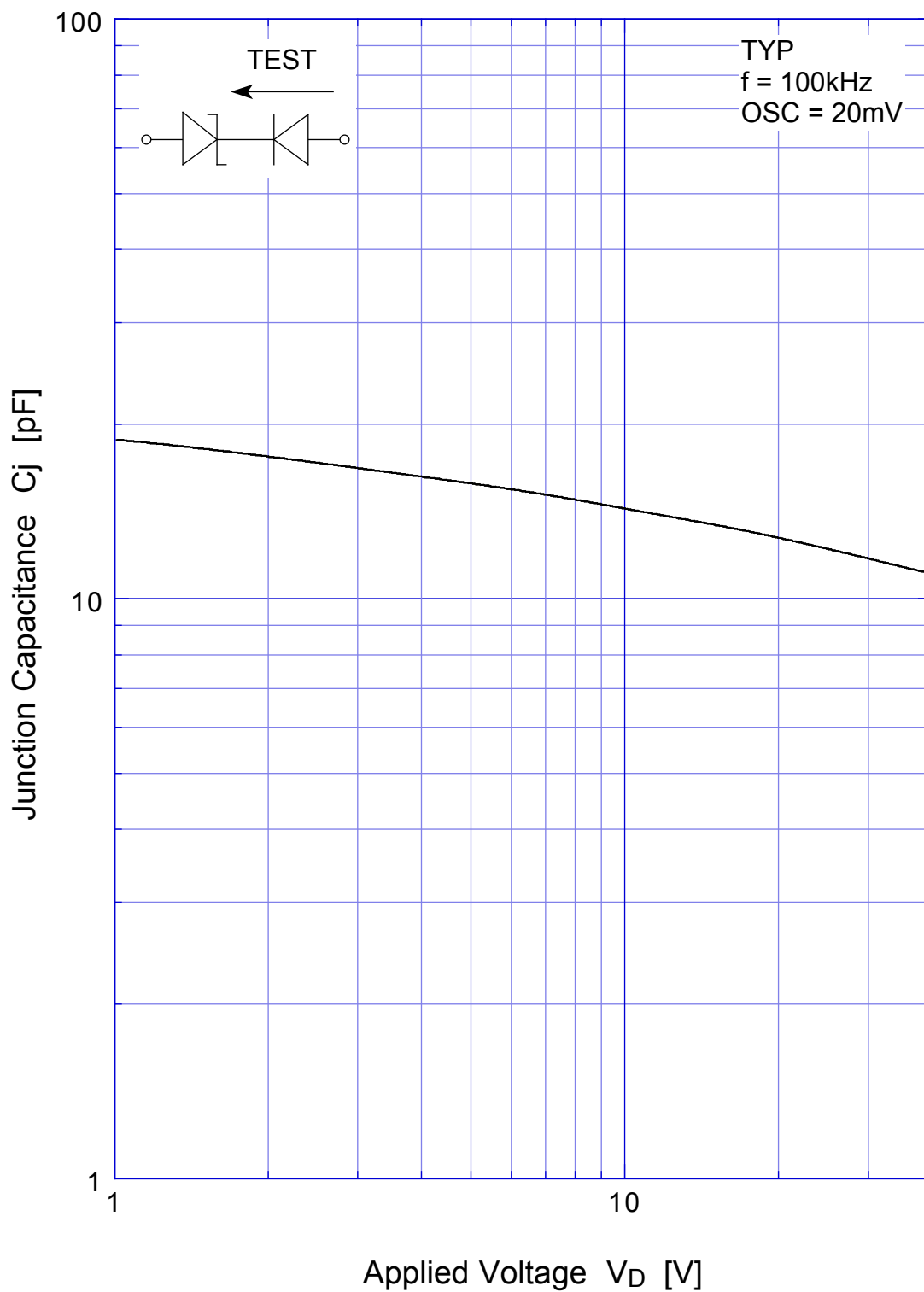

ST02D-170 Junction Capacitance

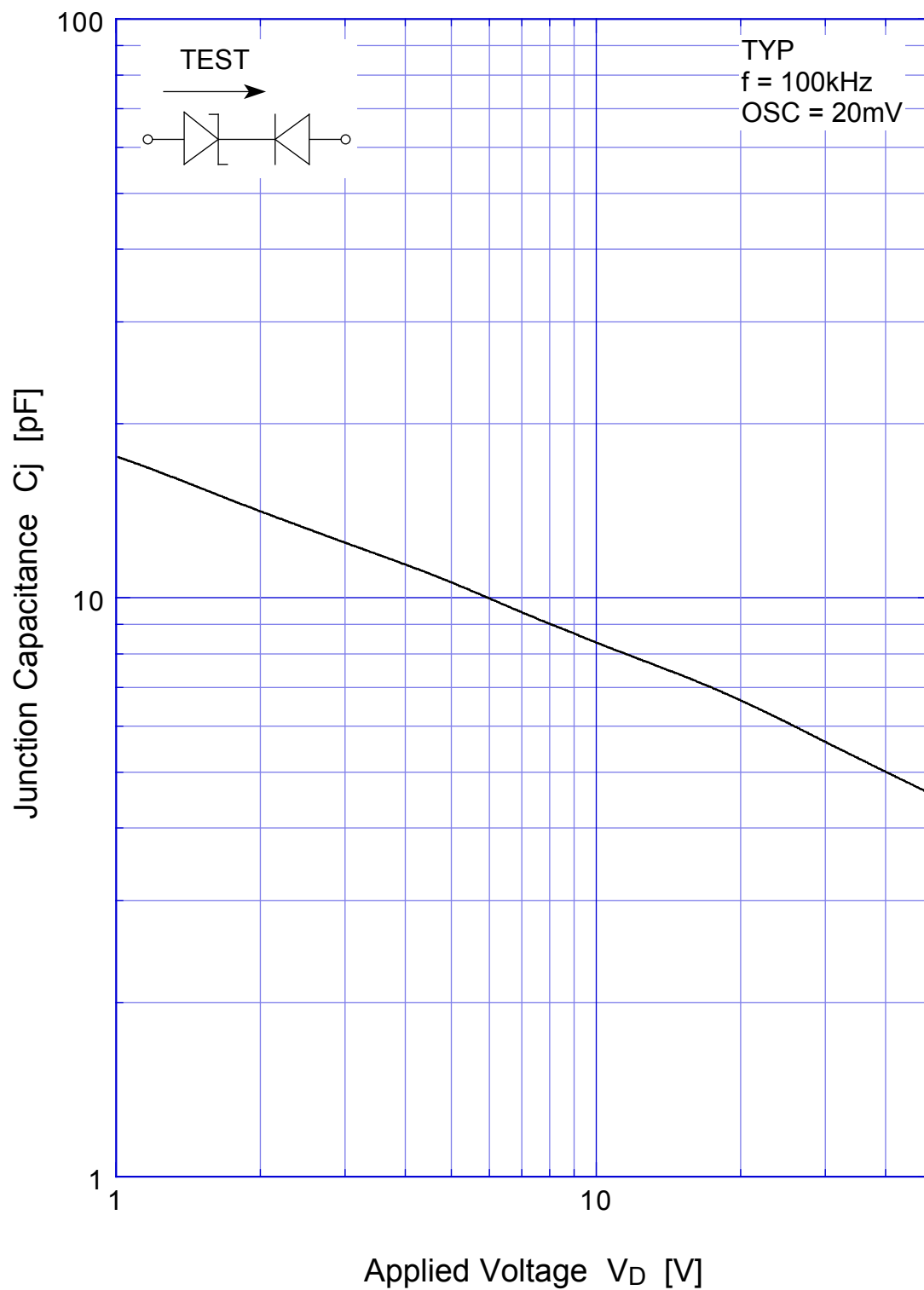

This datasheet has been download from:

www.datasheetcatalog.com

Datasheets for electronics components.