

NPN Silicon AF Transistors

BCX 58
BCX 59

- High current gain
- Low collector-emitter saturation voltage
- Complementary types: BCX 78, BCX 79 (PNP)

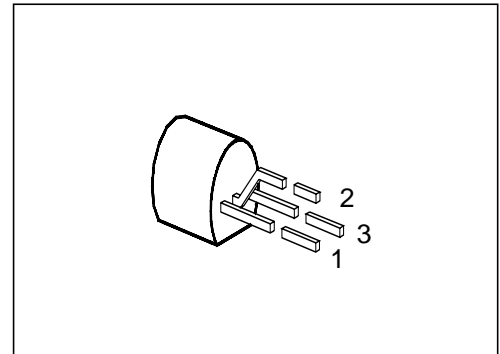

Type	Marking	Ordering Code	Pin Configuration			Package ¹⁾
			1	2	3	
BCX 58 VIII BCX 58 IX BCX 58 X BCX 59 VIII BCX 59 IX BCX 59 X	–	Q62702-C619 Q62702-C620 Q62702-C621 Q62702-C623 Q62702-C624 Q62702-C625	C	B	E	TO-92

Maximum Ratings

Parameter	Symbol	Values		Unit
		BCX 58	BCX 59	
Collector-emitter voltage	V_{CE0}	32	45	V
Collector-base voltage	V_{CB0}	32	45	
Emitter-base voltage	V_{EB0}	7		
Collector current	I_C	100		mA
Peak collector current	I_{CM}	200		
Peak base current	I_{BM}	200		
Total power dissipation, $T_C = 70\text{ °C}$	P_{tot}	500		mW
Junction temperature	T_j	150		°C
Storage temperature range	T_{stg}	– 65 ... + 150		

Thermal Resistance

Junction - ambient	$R_{th\ JA}$	≤ 250	K/W
Junction - case ²⁾	$R_{th\ JC}$	≤ 160	

¹⁾ For detailed information see chapter Package Outlines.

²⁾ Mounted on Al heat sink 15 mm × 25 mm × 0.5 mm.

Electrical Characteristics

at $T_A = 25\text{ °C}$, unless otherwise specified.

Parameter	Symbol	Values			Unit
		min.	typ.	max.	

DC characteristics

Collector-emitter breakdown voltage $I_C = 2\text{ mA}$	$V_{(BR)CE0}$	32 45	— —	— —	V
Collector-base breakdown voltage $I_C = 10\text{ }\mu\text{A}$	$V_{(BR)CB0}$	32 45	— —	— —	
Emitter-base breakdown voltage $I_E = 1\text{ }\mu\text{A}$	$V_{(BR)EB0}$	7	—	—	
Collector cutoff current $V_{CB} = 32\text{ V}$ BCX 58 $V_{CB} = 45\text{ V}$ BCX 59 $V_{CB} = 32\text{ V}, T_A = 150\text{ °C}$ BCX 58 $V_{CB} = 45\text{ V}, T_A = 150\text{ °C}$ BCX 59	I_{CB0}	— — — —	— — — —	20 20 10 10	nA nA μA μA
Collector cutoff current $V_{CE} = 32\text{ V}, V_{BE} = 0.2\text{ V}, T_A = 100\text{ °C}$ $V_{CE} = 45\text{ V}, V_{BE} = 0.2\text{ V}, T_A = 100\text{ °C}$	I_{CEX}	— —	— —	20 20	μA
Emitter cutoff current $V_{EB} = 4\text{ V}$	I_{EB0}	—	—	20	nA
DC current gain $I_C = 10\text{ }\mu\text{A}, V_{CE} = 5\text{ V}$ BCX 58 VII, BCX 59 VII BCX 58 VIII, BCX 59 VIII BCX 58 IX, BCX 59 IX BCX 58 X, BCX 59 X $I_C = 2\text{ mA}, V_{CE} = 5\text{ V}$ BCX 58 VII, BCX 59 VII BCX 58 VIII, BCX 59 VIII BCX 58 IX, BCX 59 IX BCX 58 X, BCX 59 X $I_C = 100\text{ mA}, V_{CE} = 1\text{ V}^1)$ BCX 58 VII, BCX 59 VII BCX 58 VIII, BCX 59 VIII BCX 58 IX, BCX 59 IX BCX 58 X, BCX 59 X	h_{FE}	20 20 40 100 120 180 250 380 40 45 60 60	78 145 220 300 170 250 350 500 — — — —	— — — — 220 310 460 630 — — — —	—

1) Pulse test: $t \leq 300\text{ }\mu\text{s}, D \leq 2\text{ %}$.

Electrical Characteristics

at $T_A = 25\text{ °C}$, unless otherwise specified.

Parameter	Symbol	Values			Unit
		min.	typ.	max.	

DC characteristics

Collector-emitter saturation voltage ¹⁾ $I_C = 100\text{ mA}$, $I_B = 2.5\text{ mA}$	V_{CEsat}	–	–	0.5	V
Base-emitter saturation voltage ¹⁾ $I_C = 100\text{ mA}$, $I_B = 2.5\text{ mA}$	V_{BEsat}	–	–	1.0	
Base-emitter voltage $I_C = 10\text{ }\mu\text{A}$, $V_{CE} = 5\text{ V}$ $I_C = 2\text{ mA}$, $V_{CE} = 5\text{ V}$ $I_C = 100\text{ mA}$, $V_{CE} = 1\text{ V}$ ¹⁾	$V_{BE(on)}$	– 0.55 –	0.52 0.65 0.83	– 0.75 –	

¹⁾ Pulse test: $t \leq 300\text{ }\mu\text{s}$, $D \leq 2\text{ %}$.

Electrical Characteristics

at $T_A = 25^\circ\text{C}$, unless otherwise specified.

Parameter	Symbol	Values			Unit
		min.	typ.	max.	

AC characteristics

Transition frequency $I_C = 20\text{ mA}$, $V_{CE} = 5\text{ V}$, $f = 100\text{ MHz}$	f_T	–	200	–	MHz
Output capacitance $V_{CB} = 10\text{ V}$, $f = 1\text{ MHz}$	C_{obo}	–	3	–	pF
Input capacitance $V_{CB} = 0.5\text{ V}$, $f = 1\text{ MHz}$	C_{ibo}	–	8	–	
Short-circuit input impedance $I_C = 2\text{ mA}$, $V_{CE} = 5\text{ V}$, $f = 1\text{ kHz}$	h_{11e}				k Ω
BCX 58 VII, BCX 59 VII	–	2.7	–		
BCX 58 VIII, BCX 59 VIII	–	3.6	–		
BCX 58 IX, BCX 59 IX	–	4.5	–		
BCX 58 X, BCX 59 X	–	7.5	–		
Open-circuit reverse voltage transfer ratio $I_C = 2\text{ mA}$, $V_{CE} = 5\text{ V}$, $f = 1\text{ kHz}$	h_{12e}				10^{-4}
BCX 58 VII, BCX 59 VII	–	1.5	–		
BCX 58 VIII, BCX 59 VIII	–	2.0	–		
BCX 58 IX, BCX 59 IX	–	2.0	–		
BCX 58 X, BCX 59 X	–	3.0	–		
Short-circuit forward current transfer ratio $I_C = 2\text{ mA}$, $V_{CE} = 5\text{ V}$, $f = 1\text{ kHz}$	h_{21e}				–
BCX 58 VII, BCX 59 VII	–	200	–		
BCX 58 VIII, BCX 59 VIII	–	260	–		
BCX 58 IX, BCX 59 IX	–	330	–		
BCX 58 X, BCX 59 X	–	520	–		
Open-circuit output admittance $I_C = 2\text{ mA}$, $V_{CE} = 5\text{ V}$, $f = 1\text{ kHz}$	h_{22e}				μS
BCX 58 VII, BCX 59 VII	–	18	–		
BCX 58 VIII, BCX 59 VIII	–	24	–		
BCX 58 IX, BCX 59 IX	–	30	–		
BCX 58 X, BCX 59 X	–	50	–		
Noise figure $I_C = 0.2\text{ mA}$, $V_{CE} = 5\text{ V}$, $R_S = 2\text{ k}\Omega$ $f = 1\text{ kHz}$, $\Delta f = 200\text{ Hz}$	F	–	2	–	dB

Total power dissipation $P_{tot} = f(T_A; T_C)$

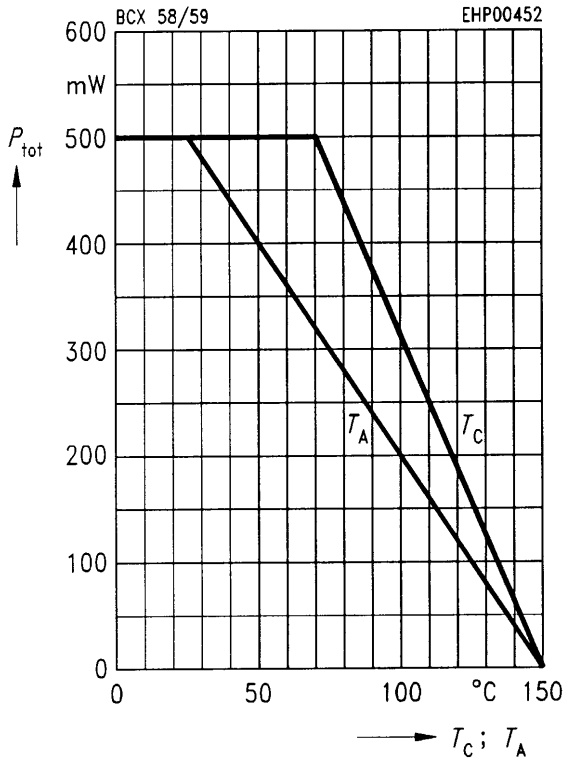

Collector current $I_C = f(V_{BE})$
 $V_{CE} = 5\text{ V}$ (common emitter configuration)

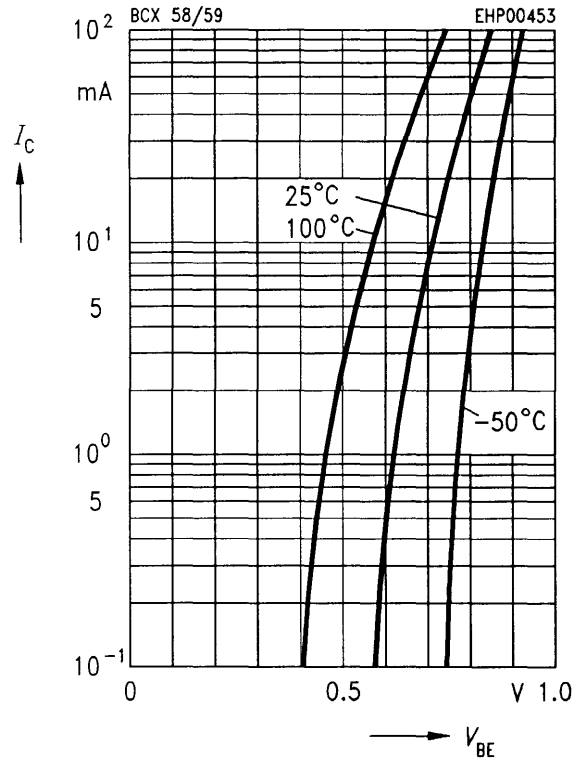

Permissible pulse load $R_{thJA} = f(t_p)$

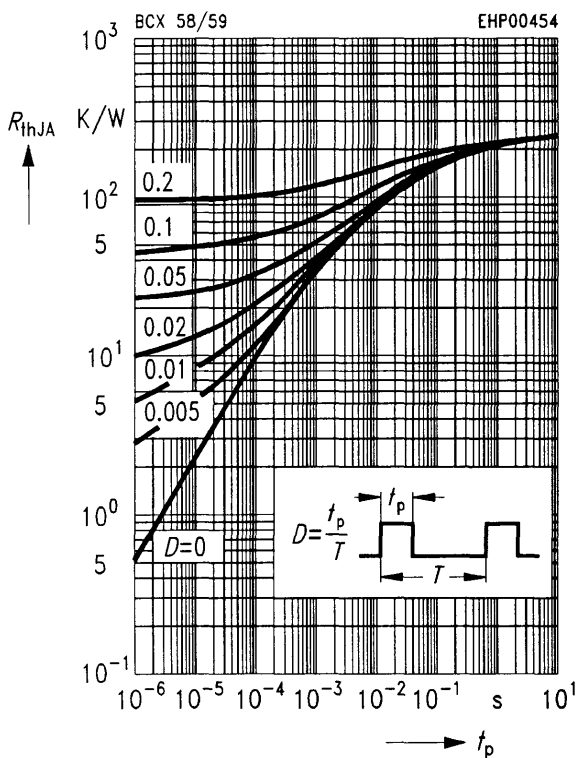

DC current gain $h_{FE} = f(I_C)$
 $V_{CE} = 5\text{ V}$ (common emitter configuration)

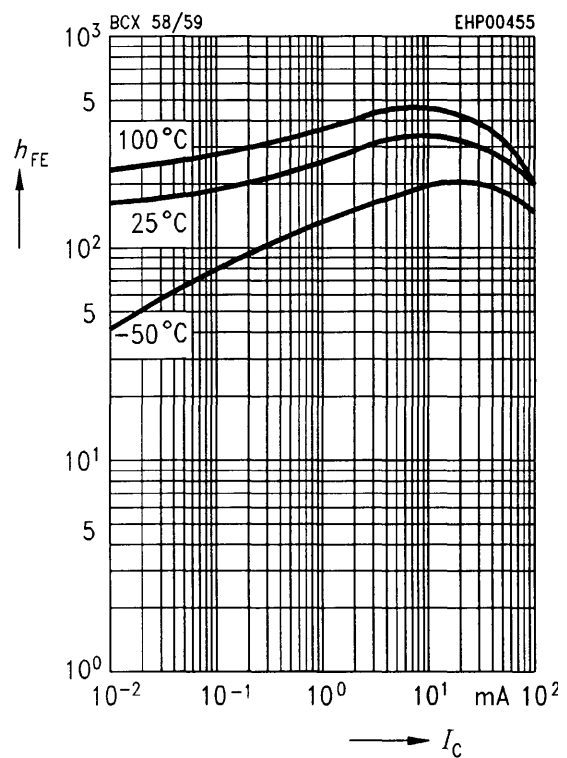

Collector cutoff current $I_{CB0} = f(T_A)$
 $V_{CB} = 45 \text{ V}$

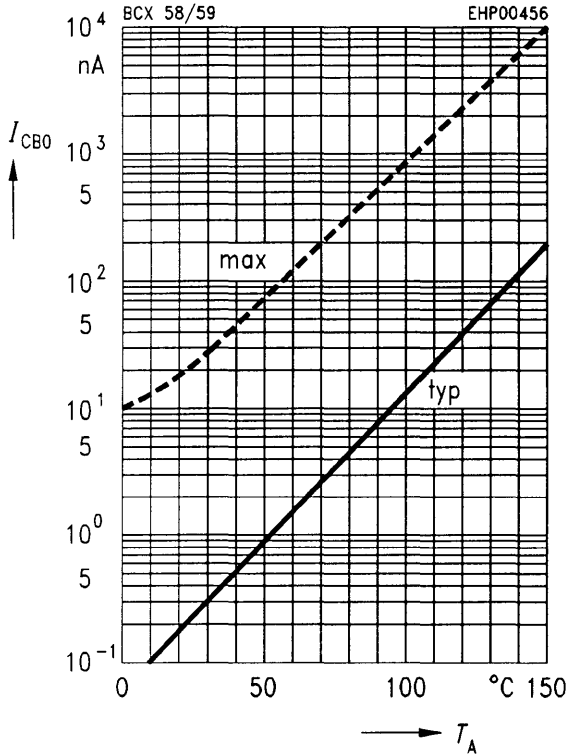

Transition frequency $f_T = f(I_C)$
 $V_{CE} = 5 \text{ V}, f = 100 \text{ MHz}$

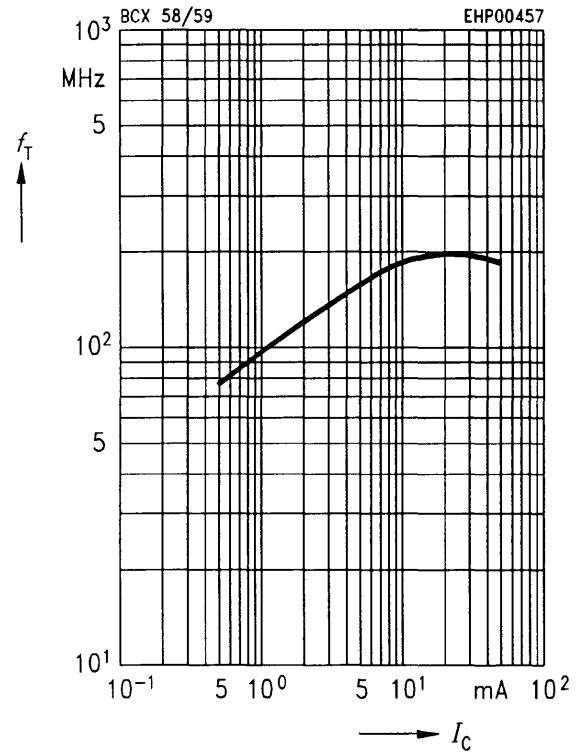

Base-emitter saturation voltage

$I_C = f(V_{BEsat})$
 $h_{FE} = 20$

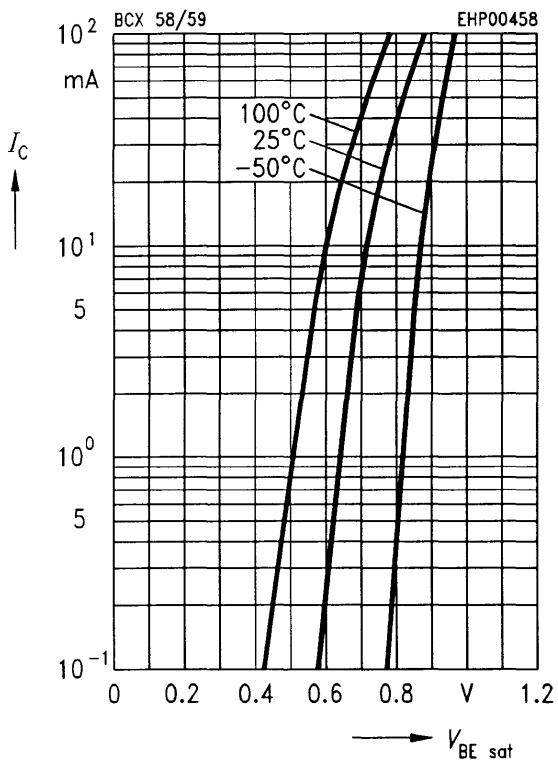

Collector-emitter saturation voltage

$I_C = f(V_{CEsat})$
 $h_{FE} = 20$

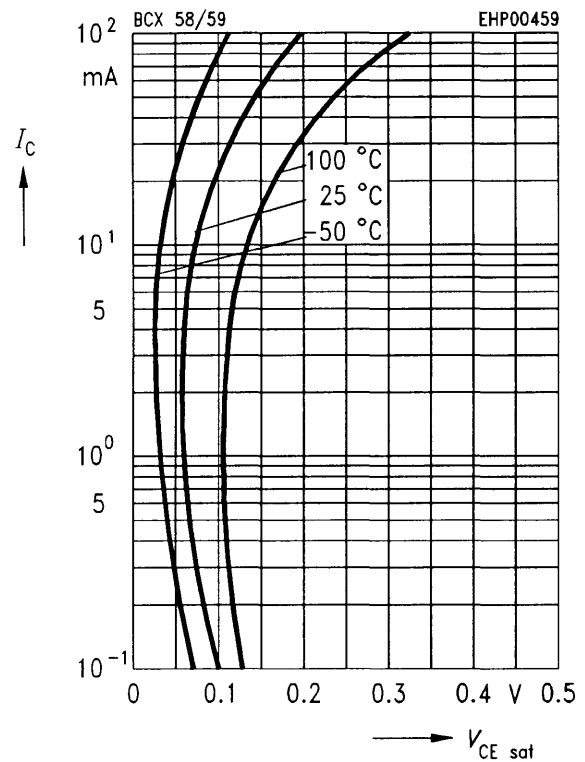

This datasheet has been download from:

www.datasheetcatalog.com

Datasheets for electronics components.