

8002 DataSheet V1.0

CONTENTS

General Description.....4

Features.....4

Applications.....4

Typical Application Circuit.....4

Absolute Maximum Ratings.....5

Electrical Characteristics.....5

Pin Configuration.....6

Pin Layout.....6

Pin Discription.....6

Typical Characteristics.....7

THD, THD+N,S/N.....7

Power Supply Rejection Ratio (PSRR).....9

Power Dissipation.....10

Output Power.....11

Application Information.....12

BLOCK DIAGRAM.....12

BRIDGE CONFIGURATION EXPLANATION.....13

POWER DISSIPATION.....13

POWER SUPPLY BYPASSING.....14

SHUTDOWN FUNCTION.....14

PROPER SELECTION OF EXTERNAL COMPONENTS.....14

Selection of Input Capacitor Size.....15

AUDIO POWER AMPLIFIER DESIGN.....15

A 1W/8Ω Audio Amplifier.....15

Physical Size of Chip Package.....17

FIGURE LIST

Figure1. typical Audio Amplifier Application Circuit.....4

Figure2. SOP Package Pin Distribution.....6

Figure3. The block diagram of 8002.....12

Figure4. The Package of SOP-8.....17

TABLE LISTS

Table1. Chip Limit Parameter Table.....5

Table2. Electrical Characteristics.....5

Table3. Pin Discription.....6

General Description

The 8002 is an audio power amplifier primarily designed for demanding applications in low-power portable systems. It is capable of delivering 3 watts of continuous average power to a 3Ω BTL load with less than 10% distortion (THD) from a 5VDC power supply. the 8002 does not require output coupling capacitors or bootstrap capacitors, and therefore is ideally suited for mobile phone and other low voltage applications where minimal power consumption is a primary requirement.the 8002 features a low-power consumption shutdown mode.the 8002 contains advanced pop & click circuitry which eliminates noise which would otherwise occur during turn-on and turn-off transitions. The 8002 is unity-gain stable and can be configured by external gain-setting resistors

Features

Power Output at 5.0V, 10% THD+N, 3Ω 3W (typ)

Power Output at 5.0V,10% THD+N,4Ω 2.65W (typ)

Power Output at 5.0V,10% THD+N,8Ω 1.8W (typ)

Shutdown Current 0.6μA (typ)

Available in space-saving packages: SOP

Improved pop & click circuitry eliminates noise during turn-on and turn-off transitions

2.20- 5.5V operation

No output coupling capacitors, snubber networks or bootstrap capacitors required

Unity-gain stable

External gain configuration capability

Applications

Portable computers

Desktop computers

Low voltage audio systems

Typical Application Circuit

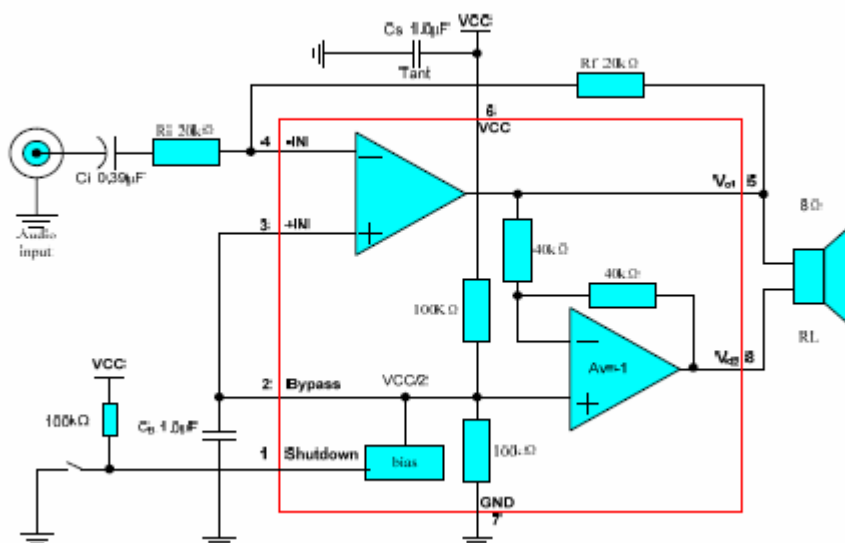

typical Audio Amplifier Application Circuit

Absolute Maximum Ratings

Chip Limit Parameter Table

Name	Parameter
Supply Voltage	6.0V
Storage Temperature	-65°C to +150°C
Input Voltage	-0.3V to VDD +0.3V
ESD Susceptibility	2000V
Junction Temperature	150°C
Thermal Resistance	
θJA	210°C/W
θJC	56°C/W

WARNING: In addition to limits or any other conditions, the chip may be damaged.

Electrical Characteristics

The following specifications apply for V_{DD}=5V and R_L=8 Ω, unless otherwise specified. Limits apply for TA = 25°C.

Electrical Characteristics

Symbol	Parameter	Conditions	8002		Units (Limits)
			Typical	Max	
IDD	Quiescent Power Supply Current	V _{IN} =0V, I _o =0A, No load	6.5	10	mA
		V _{IN} =0V, I _o =0A, 8load	7.0	10	mA
IOFF	Shutdown Current		0.8	2	uA
VOS	Outpt Offset Voltage		5.7	30	mV
RO	Resistor Output		8.5	10	K Ω
PO	Output Power, 3 Ω Load	THD ≤ 1%, f=1KHz	2.3		W
	Output Power, 4 Ω Load	THD ≤ 1%, f=1KHz	2		
	Output Power, 8 Ω Load	THD ≤ 1%, f=1KHz	1.3		
	Output Power, 3 Ω Load	THD+N ≤ 10%, f=1KHz	3		W
	Output Power, 4 Ω Load	THD+N ≤ 10%, f=1KHz	2.56		
	Output Power, 8 Ω Load	THD+N ≤ 10%, f=1KHz	1.8		
TD	Wake-up time		100		mS
THD+N	Total Harmonic Distortion+Noise	20Hz ≤ f ≤ 20kHz, A _{VD} = 2 R _L = 8Ω, P _o = 1W	0.2		%
PSRR	Power Supply Rejection Ratio	V _{ripple} =200mV sine P-P Input terminated With 10 Ω	63(f=217Hz) 67(f=1KHz)	60 (min)	dB

Pin Configuration

Pin Layout

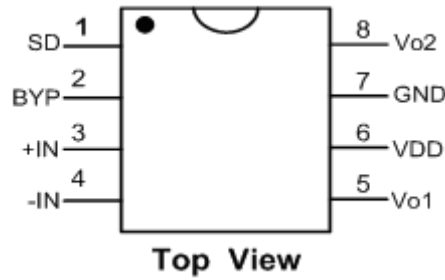

SOP Package Pin Distribution

Pin Discription

Tab13. Pin Discription

Pin NO.	Pin Name	Description
1	SD	The device enters in shutdown mode when a high level is applied on this pin
2	BYP	Bypass capacitor pin which provides the common mode voltage
3	+IN	Positive input of the first amplifier, receives the common mode voltage
4	-IN	Negative input of the first amplifier, receives the audio input signal
5	Vo1	Negative output
6	VDD	Analog VDD input supply.
7	GND	Ground connection for circuitry.
8	Vo2	Positive output

Typical Characteristics

THD, THD+N,S/N

THD vs Frequency
T=25°C, Vdd=5V, RL=8 Ω, and Po=500mW

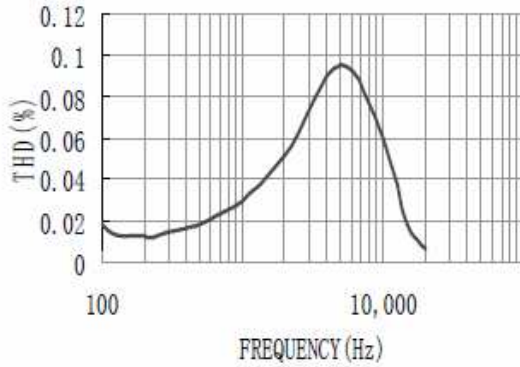

THD vs Frequency
T=25°C, Vdd=3.3V, RL=8 Ω, and Po=425mW

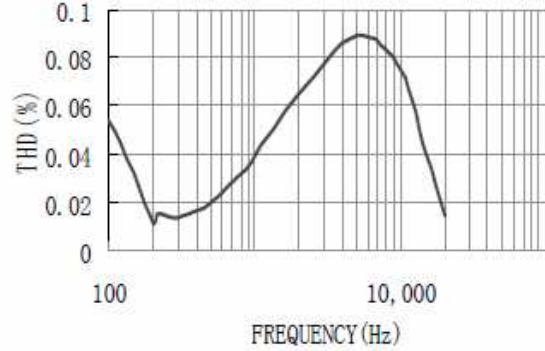

THD vs Frequency
T=25°C, Vdd=2.5V, RL=8 Ω, and Po=150mW

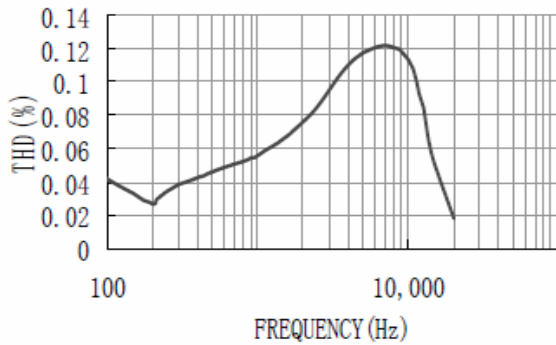

THD vs Frequency
T=25°C, Vdd=3.3V, RL=4 Ω, and Po=425mW

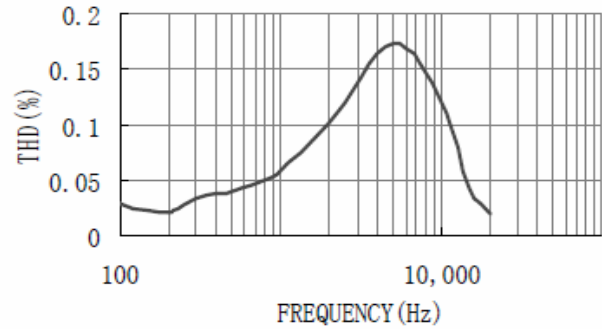

THD vs Frequency
T=25°C, Vdd=2.5V, RL=4 Ω, and Po=150mW

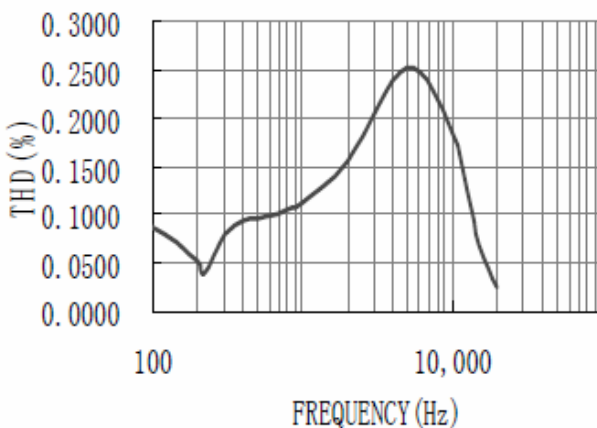

THD+N vs Frequency
T=25°C, Vdd=5V, RL=8 Ω, and Po=500mW

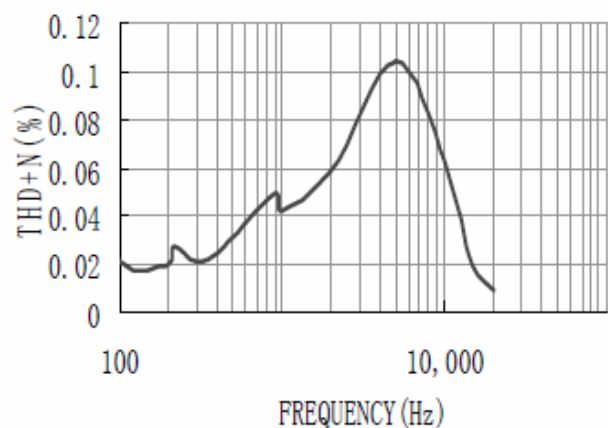

THD+N vs Frequency
T=25°C, Vdd=3.3V, RL=8Ω, and Po=425mW

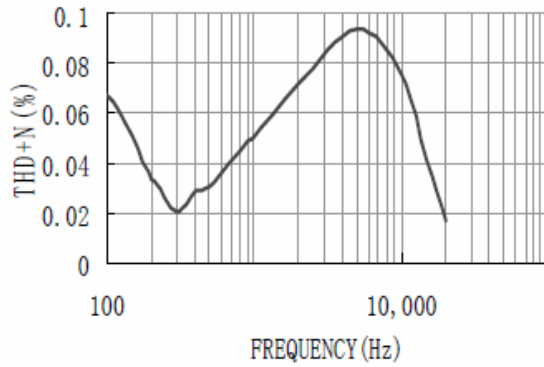

THD+N vs Frequency
T=25°C, Vdd=2.5V, RL=8Ω, and Po=150mW

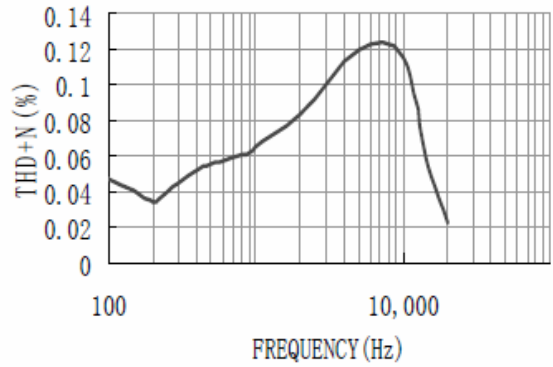

THD+N vs Frequency
T=25°C, Vdd=3.3V, RL=4Ω, and Po=425mW

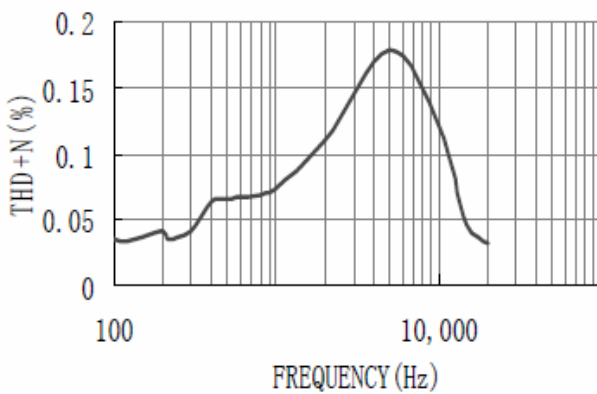

THD+N vs Frequency
T=25°C, Vdd=2.5V, RL=4Ω, and Po=150mW

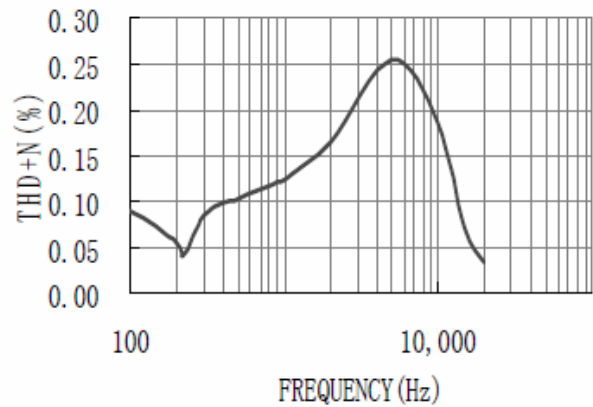

S/N vs Frequency
T=25°C, Vdd=5V, RL=8Ω, and Po=500mW

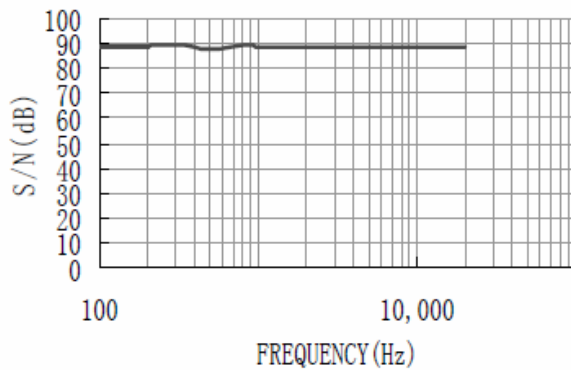

S/N vs Frequency
T=25°C, Vdd=3.3V, RL=8Ω, and Po=425mW

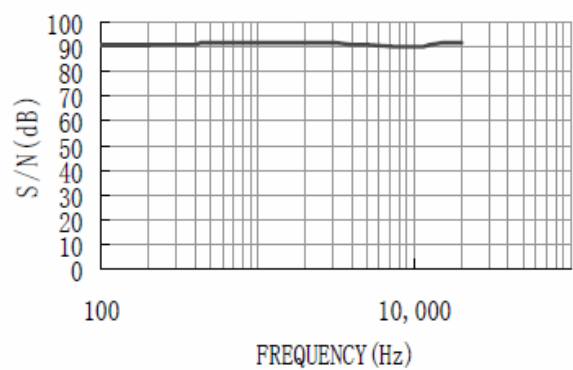

S/N vs Frequency
T=25°C, Vdd=2.5V, RL=8Ω, and Po=150mW

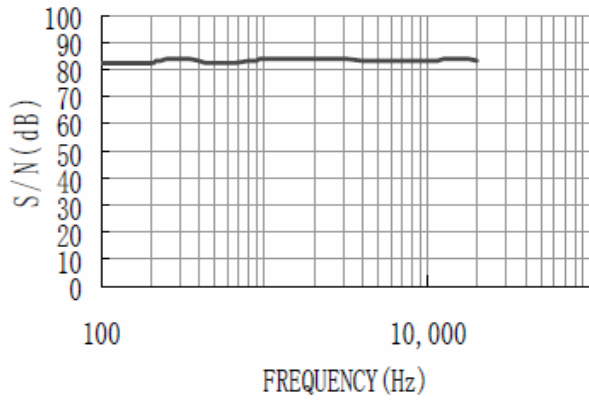

S/N vs Frequency
T=25°C, Vdd=3.3V, RL=4Ω, and Po=425mW

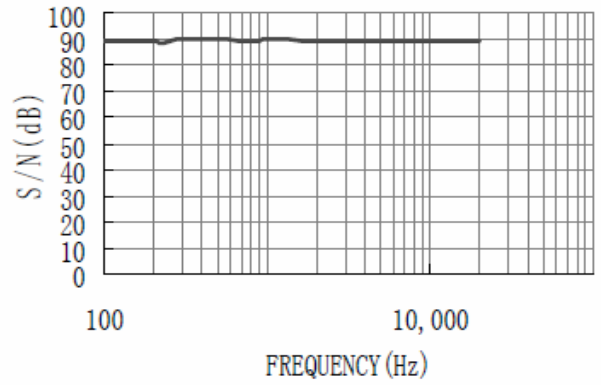

S/N vs Frequency
T=25°C, Vdd=2.5V, RL=4Ω, and Po=150mW

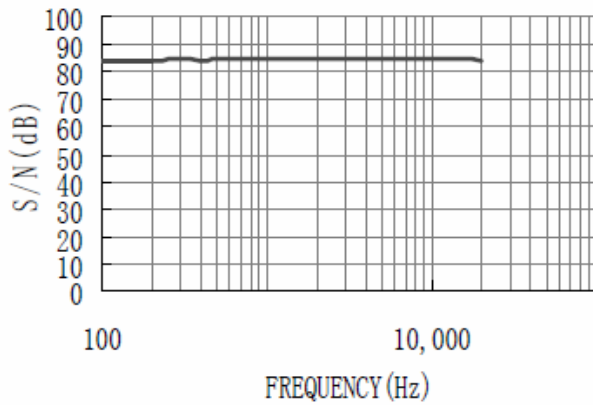

Power Supply Rejection Ratio (PSRR)

PSRR vs Frequency
VDD=5V, RL=8Ω, Input 10Ω terminated

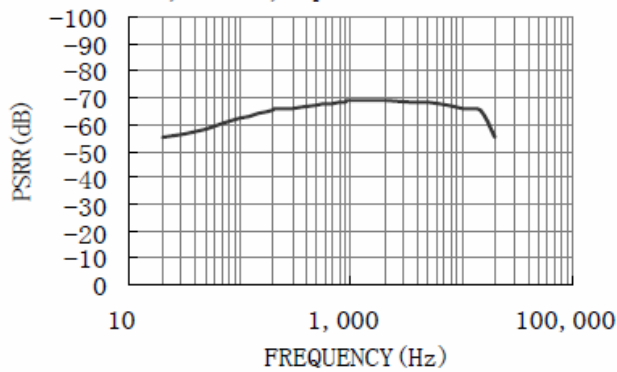

PSRR vs Frequency
VDD=5V, RL=8Ω, Input Floating

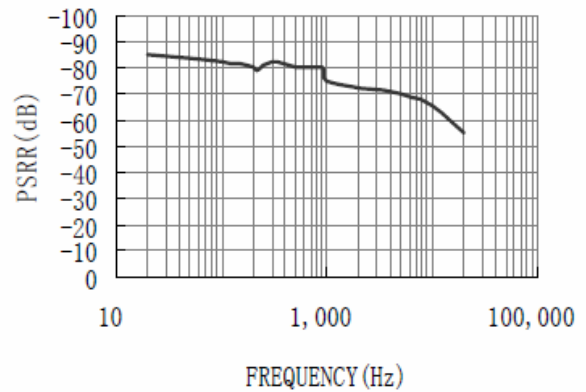

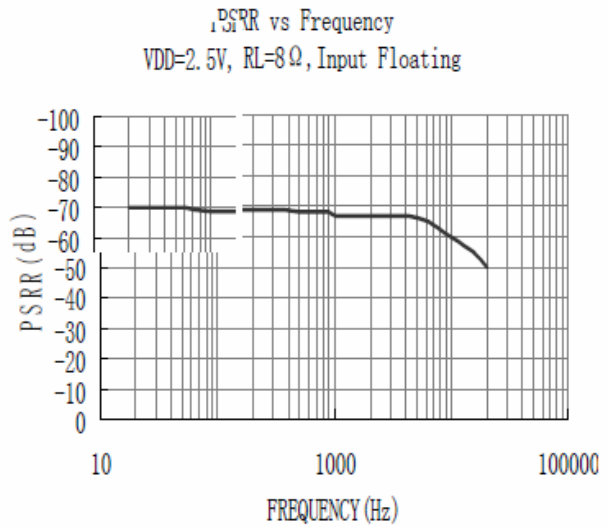
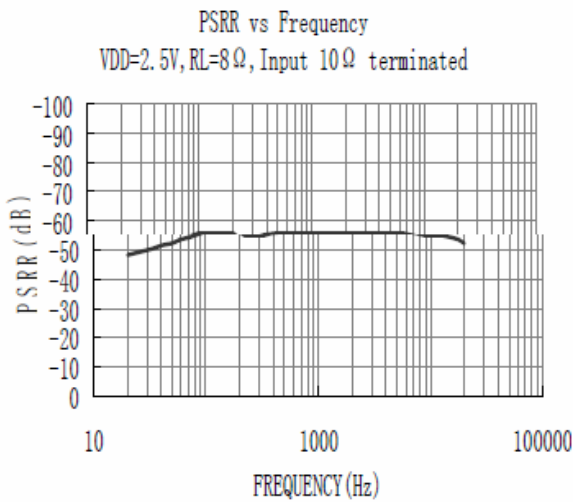
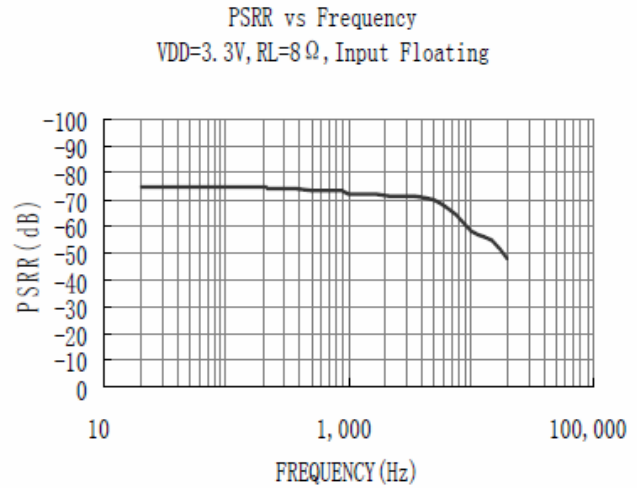
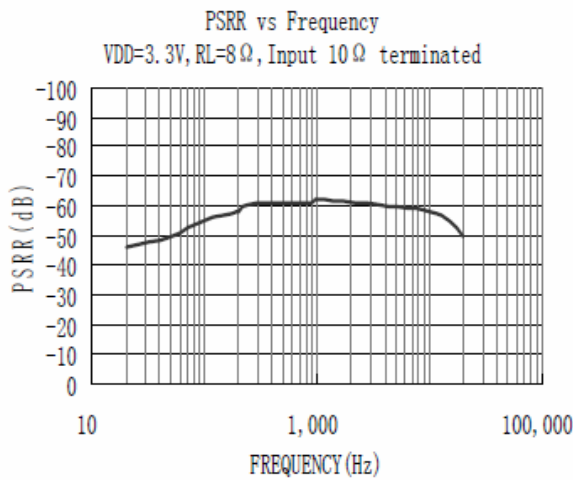

Power Dissipation

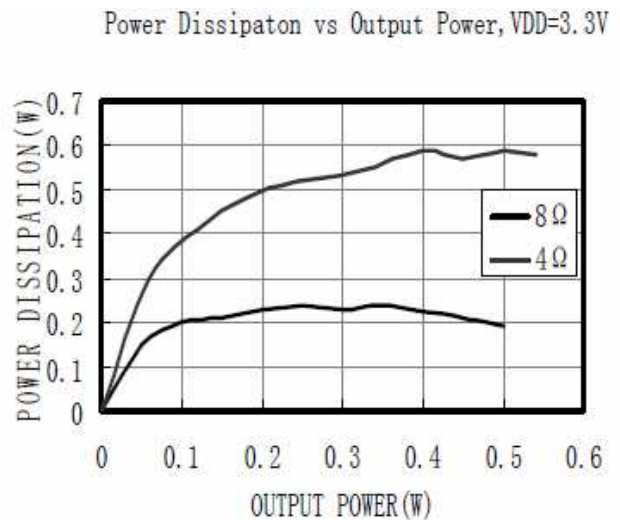
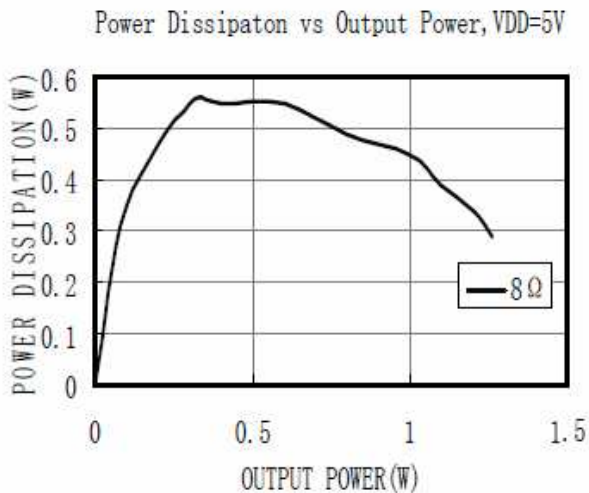

Power Dissipation vs Output Power, VDD=2.5V

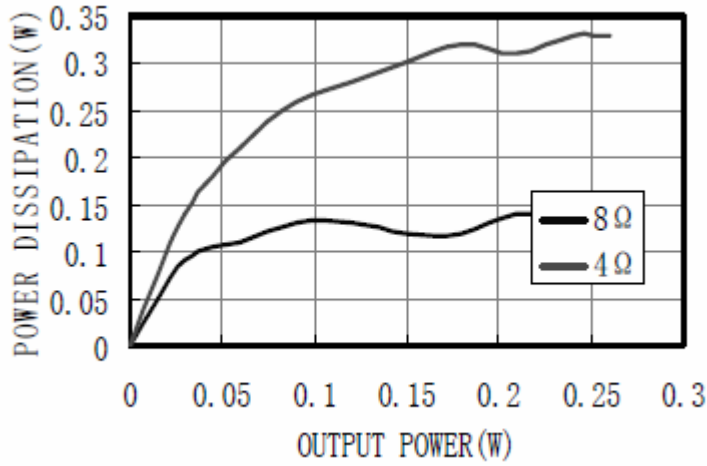

Output Power

THD+N vs OutputPower VDD=5V, RL=8Ω, and f=1KHz

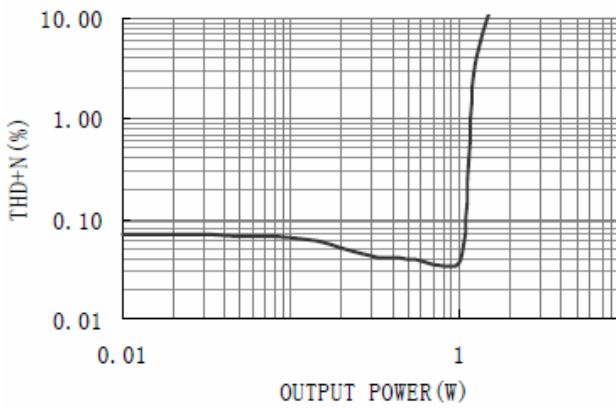

THD+N vs OutputPower VDD=3.3V, RL=8Ω, and f=1KHz

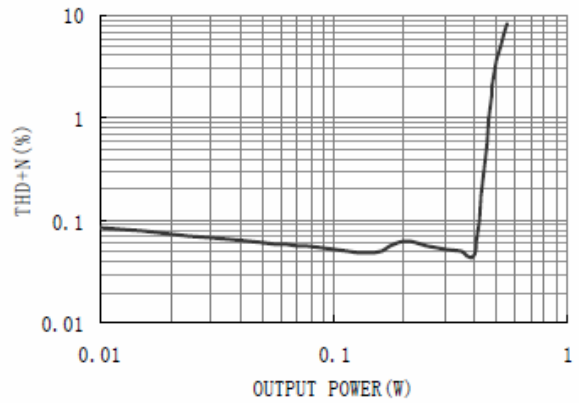

THD+N vs OutputPower VDD=2.5V, RL=8Ω, and f=1KHz

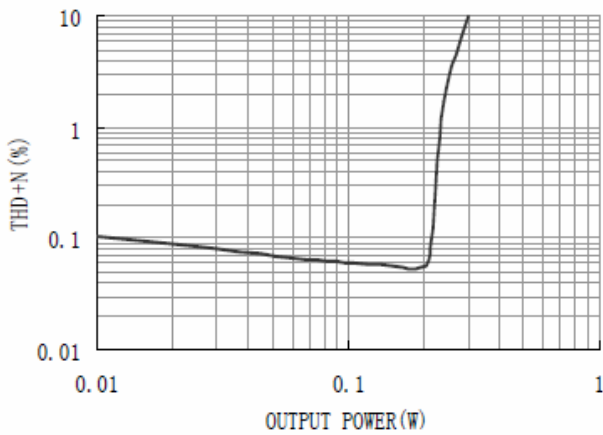

THD+N vs OutputPower VDD=3.3V, RL=4Ω, and f=1KHz

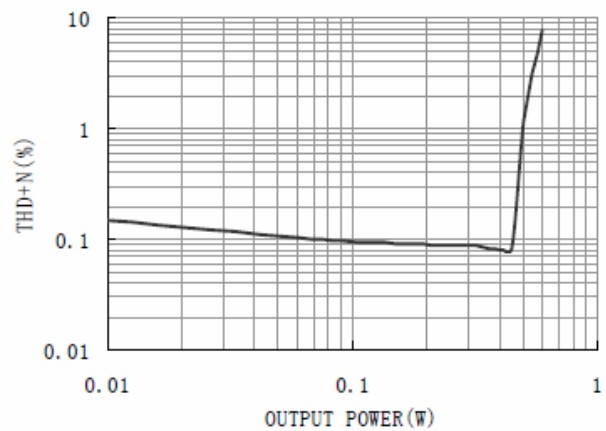

THD+N vs OutputPower VDD=2.5V, RL=4Ω, and f=1KHz

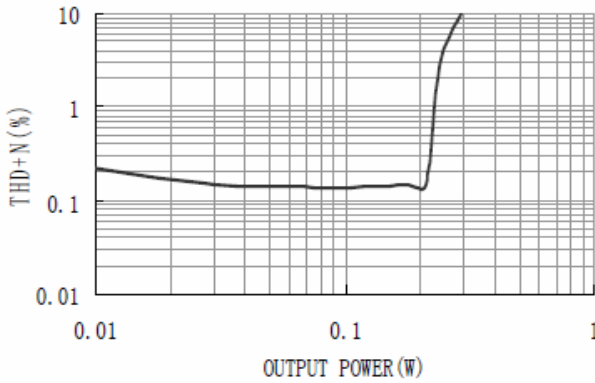

Output Power vs Supply Voltage, RL=4Ω

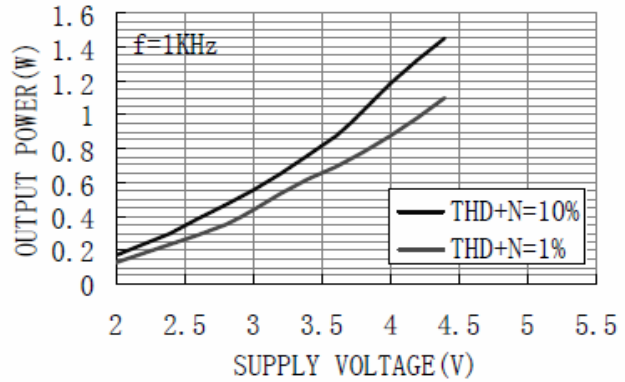

Output Power vs Supply Voltage, RL=8Ω

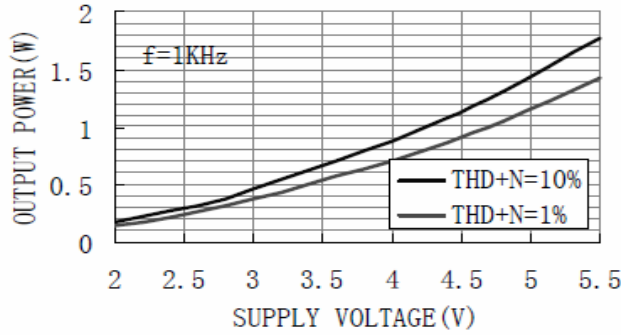

Output Power vs Supply Voltage, RL=16Ω

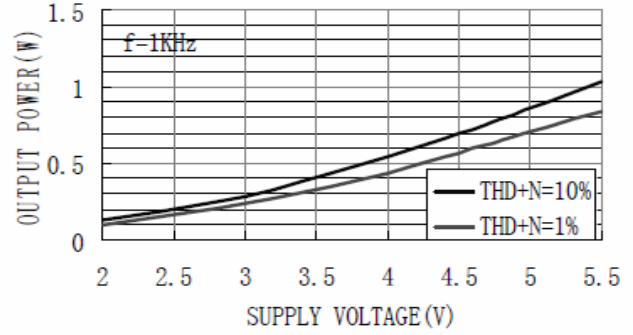

Application Information

BLOCK DIAGRAM

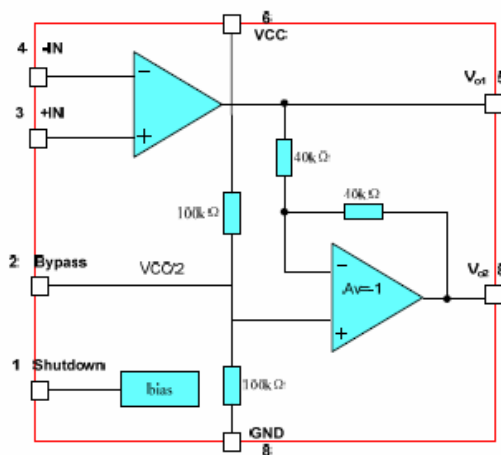

The block diagram of 8002

BRIDGE CONFIGURATION EXPLANATION

As shown in Figure 1, the 8002 has two internal operational amplifiers. The first amplifier's gain is externally configurable, while the second amplifier is internally fixed in a unity-gain, inverting configuration. The closed-loop gain of the first amplifier is set by selecting the ratio of R_f to R_i while the second amplifier's gain is fixed by the two internal 20k Ω resistors. Figure 1 shows that the output of amplifier one serves as the input to amplifier two which results in both amplifiers producing signals identical in magnitude, but out of phase by 180°. Consequently, the differential gain for the IC is

$$A_{VD} = 2 \times \frac{R_f}{R_i}$$

By driving the load differentially through outputs V_{o1} and V_{o2} , an amplifier configuration commonly referred to as "bridged mode" is established. Bridged mode operation is different from the classical single-ended amplifier configuration where one side of the load is connected to ground.

A bridge amplifier design has a few distinct advantages over the single-ended configuration, as it provides differential drive to the load, thus doubling output swing for a specified supply voltage. Four times the output power is possible as compared to a single-ended amplifier under the same conditions. This increase in attainable output power assumes that the amplifier is not current limited or clipped. In order to choose an amplifier's closed-loop gain without causing excessive clipping, please refer to the Audio Power Amplifier Design section.

A bridge configuration, such as the one used in 8002, also creates a second advantage over single-ended amplifiers. Since the differential outputs, V_{o1} and V_{o2} , are biased at half-supply, no net DC voltage exists across the load. This eliminates the need for an output coupling capacitor which is required in a single supply, single-ended amplifier configuration. Without an output coupling capacitor, the half-supply bias across the load would result in both increased internal IC power dissipation and also possible loudspeaker damage.

POWER DISSIPATION

Power dissipation is a major concern when designing a successful amplifier, whether the amplifier is bridged or single-ended. A direct consequence of the increased power delivered to the load by a bridge amplifier is an increase in internal power dissipation. Since the 8002 has two operational amplifiers in one package, the maximum internal power dissipation is 4 times that of a single-ended amplifier.

The maximum power dissipation for a given application can be derived from the power dissipation graphs or from Equation 1.

$$P_{DMAX} = 4 \times \frac{V_{DD}^2}{2\pi^2 R_L}$$

It is critical that the maximum junction temperature T_{JMAX} of 150°C is not exceeded. T_{JMAX} can be determined from the power derating curves by using P_{DMAX} and the PC board foil area. By adding copper foil, the thermal resistance of the application can be reduced from the free air value of θ_{JA} , resulting in higher P_{DMAX} values without thermal shutdown protection circuitry being activated. Additional copper foil can be added to any of the leads connected to the 8002. It is especially effective when connected to VDD, GND, and the output pins. Refer to the application information on the 8002 reference design board for an example of good heat sinking. If T_{JMAX} still exceeds 150°C, then

additional changes must be made. These changes can include reduced supply voltage, higher load impedance, or reduced ambient temperature. Internal power dissipation is a function of output power. Refer to the Typical Performance Characteristics curves for power dissipation information for different output powers and output loading.

POWER SUPPLY BYPASSING

As with any amplifier, proper supply bypassing is critical for low noise performance and high power supply rejection. The capacitor location on both the bypass and power supply pins should be as close to the device as possible. Typical applications employ a 5V regulator with 10 μ F tantalum or electrolytic capacitor and a ceramic bypass capacitor which aid in supply stability. This does not eliminate the need for bypassing the supply nodes of the 8002. The selection of a bypass capacitor, especially CB, is dependent upon PSRR requirements, click and pop performance (as explained in the section, Proper Selection of External Components), system cost, and size constraints.

SHUTDOWN FUNCTION

In order to reduce power consumption while not in use, the 8002 contains shutdown circuitry that is used to turn off the amplifier's bias circuitry. In addition, the 8002 contains a Shutdown Mode pin (LD and MH packages only), allowing the designer to designate whether the part will be driven into shutdown with a high level logic signal or a low level logic signal. This allows the designer maximum flexibility in device use, as the Shutdown Mode pin may simply be tied permanently to either VDD or GND to set the 8002 as either a "shutdown-high" device or a "shutdown-low" device, respectively. The device may then be placed into shutdown mode by toggling the Shutdown pin to the same state as the Shutdown Mode pin. For simplicity's sake, this is called "shutdown same", as the 8002 enters shutdown mode whenever the two pins are in the same logic state. The MM package lacks this Shutdown Mode feature, and is permanently fixed as a 'shutdown-low' device. The trigger point for either shutdown high or shutdown low is shown as a typical value in the Supply Current vs Shutdown Voltage graphs in the Typical Performance Characteristics section. It is best to switch between ground and supply for maximum performance. While the device may be disabled with shutdown voltages in between ground and supply, the idle current may be greater than the typical value of 0.1 μ A. In either case, the shutdown pin should be tied to a definite voltage to avoid unwanted state changes.

In many applications, a microcontroller or microprocessor output is used to control the shutdown circuitry, which provides a quick, smooth transition to shutdown. Another solution is to use a single-throw switch in conjunction with an external pull-up resistor (or pull-down, depending on shutdown high or low application). This scheme guarantees that the shutdown pin will not float, thus preventing unwanted state changes.

PROPER SELECTION OF EXTERNAL COMPONENTS

Proper selection of external components in applications using integrated power amplifiers is critical to optimize device and system performance. While the 8002 is tolerant of external component combinations, consideration to component values must be used to maximize overall system quality. The 8002 is unity-gain stable which gives the designer maximum system flexibility. The 8002 should be used in low gain configurations to minimize THD+N+N values, and maximize the signal to noise ratio. Low gain configurations require large input signals to obtain a given output power. Input signals equal to or greater than 1V_{rms} are available from sources such as audio codecs. Please refer to the section, Audio

Power Amplifier Design, for a more complete explanation of proper gain selection. Besides gain, one of the major considerations is the closedloop bandwidth of the amplifier. To a large extent, the bandwidth is dictated by the choice of external components shown in Figure 1. The input coupling capacitor, C_i , forms a first order high pass filter which limits low frequency response. This value should be chosen based on needed frequency response for a few distinct reasons.

Selection of Input Capacitor Size

Large input capacitors are both expensive and space hungry for portable designs. Clearly, a certain sized capacitor is needed to couple in low frequencies without severe attenuation. But in many cases the speakers used in portable systems, whether internal or external, have little ability to reproduce signals below 100Hz to 150Hz. Thus, using a large input capacitor may not increase actual system performance.

In addition to system cost and size, click and pop performance is effected by the size of the input coupling capacitor, C_i . A larger input coupling capacitor requires more charge to reach its quiescent DC voltage (nominally $1/2 V_{DD}$). This charge comes from the output via the feedback and is apt to create pops upon device enable. Thus, by minimizing the capacitor size based on necessary low frequency response, turn-on pops can be minimized.

Besides minimizing the input capacitor size, careful consideration should be paid to the bypass capacitor value. Bypass capacitor, C_B , is the most critical component to minimize turn-on pops since it determines how fast the 8002 turns on. The slower the 8002’s outputs ramp to their quiescent DC voltage (nominally $1/2 V_{DD}$), the smaller the turn-on pop. Choosing C_B equal to $1.0\mu F$ along with a small value of C_i (in the range of $0.1\mu F$ to $0.39\mu F$), should produce a virtually clickless and popless shutdown function. While the device will function properly, (no oscillations or motorboating), with C_B equal to $0.1\mu F$, the device will be much more susceptible to turn-on clicks and pops. Thus, a value of C_B equal to $1.0\mu F$ is recommended in all but the most cost sensitive designs.

AUDIO POWER AMPLIFIER DESIGN

A 1W/8Ω Audio Amplifier

Given:	
Power Output	1Wrms
Load Impedance	8Ω
Input Level	1Vrms
Input Impedance	20kΩ
Bandwidth	100Hz–20kHz ± 0.25dB

A designer must first determine the minimum supply rail to obtain the specified output power. By extrapolating from the Output Power vs Supply Voltage graphs in the Typical Performance Characteristics section, the supply rail can be easily found.

5V is a standard voltage in most applications, it is chosen for the supply rail. Extra supply voltage creates headroom that allows the 8002 to reproduce peaks in excess of 1W without producing audible distortion. At this time, the designer must make sure that the power supply choice along with the output impedance does not violate the conditions explained in the Power Dissipation section.

Once the power dissipation equations have been addressed, the required differential gain can be determined from Equation 2.

$$A_{VD} \geq \sqrt{(P_O R_L) / (V_{IN})} = V_{ORMS} / V_{INRMS}$$

$$R_f / R_i = A_{VD} / 2$$

From Equation 2, the minimum AVD is 2.83; use AVD = 3. Since the desired input impedance was 20kΩ, and with a AVD impedance of 2, a ratio of 1.5:1 of Rf to Ri results in an allocation of Ri = 20kΩ and Rf = 30kΩ. The final design step is to address the bandwidth requirements which must be stated as a pair of -3dB frequency points. Five times away from a -3dB point is 0.17dB down from passband response which is better than the required ±0.25dB specified.

$$f_L = 100Hz / 5 = 20Hz$$

$$f_H = 20KHz \times 5 = 100KHz$$

As stated in the External Components section, Ri in conjunction with Ci create a highpass filter.

$$C_i \geq 1 / (2\pi \times 20K\Omega \times 20Hz) = 0.397\mu f$$

Use 0.39μf. The high frequency pole is determined by the product of the desired frequency pole, fH, and the differential gain, AVD. With a AVD = 3 and fH = 100kHz, the resulting GBWP = 300kHz which is much smaller than the 8002 GBWP of 2.5MHz. This figure displays that if a designer has a need to design an amplifier with a higher differential gain, the 8002 can still be used without running into bandwidth limitations.

Physical Size of Chip Package

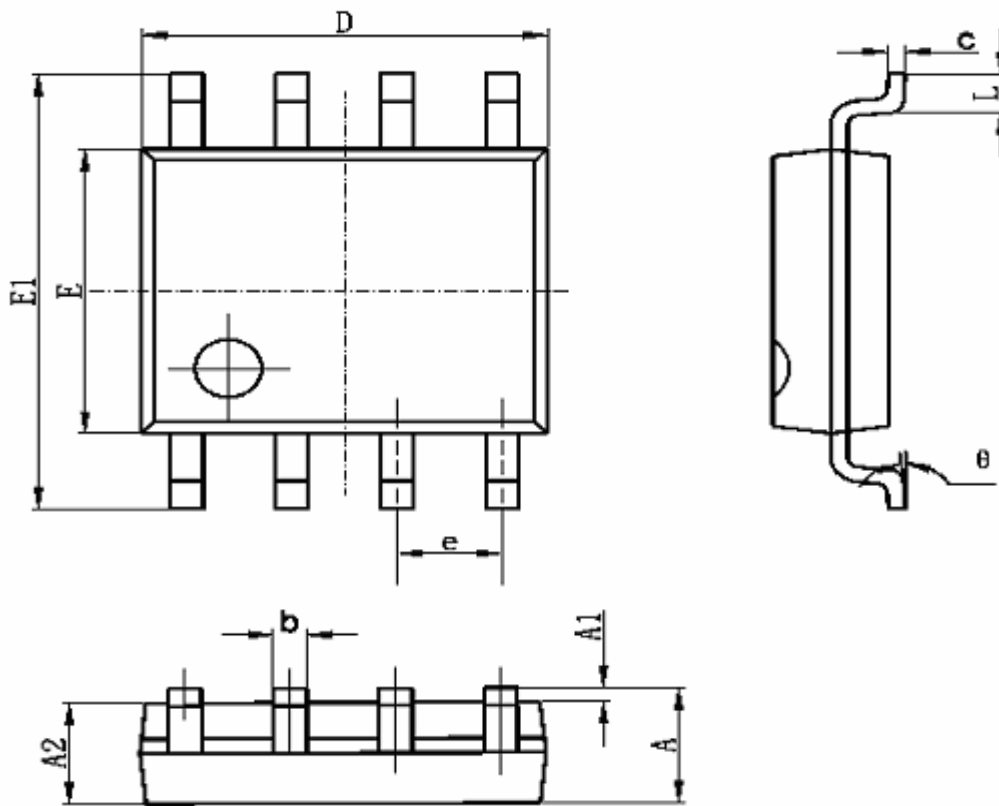

Symbol	Dimensions In Millimeters		Dimensions In Inches	
	Min	Max	Min	Max
A	1.350	1.750	0.053	0.069
A 1	0.100	0.250	0.004	0.010
A 2	1.350	1.55	0.053	0.061
b	0.330	0.510	0.013	0.020
c	0.170	0.250	0.006	0.010
D	4.700	5.100	0.185	0.200
E	3.800	4.000	0.150	0.157
E1	5.800	6.200	0.228	0.244
e	1.270(BSC)		0.050(BSC)	
L	0.400	1.270	0.016	0.050
θ	0°	8°	0°	8°

The Package of SOP-8