

DATA SHEET



TDA8588J; TDA8588xJ I²C-bus controlled 4 × 50 Watt power amplifier and multiple voltage regulator

Product specification

2004 Feb 24

I²C-bus controlled 4 × 50 Watt power amplifier and multiple voltage regulator

TDA8588J; TDA8588xJ

FEATURES

Amplifiers

- I²C-bus control
- Can drive a 2 Ω load with a battery voltage of up to 16 V and a 4 Ω load with a battery voltage of up to 18 V
- DC load detection, open, short and present
- AC load (tweeter) detection
- Programmable clip detect; 1 % or 4 %
- Programmable thermal protection pre-warning
- Independent short-circuit protection per channel
- Low gain line driver mode (20 dB)
- Loss-of-ground and open V_P safe
- All outputs protected from short-circuit to ground, to V_P or across the load
- All pins protected from short-circuit to ground
- Soft thermal-clipping to prevent audio holes
- Low battery detection.

Voltage regulators

GENERAL

- I²C-bus control
- Good stability for any regulator with almost any output capacitor value
- Five voltage regulators (microcontroller, display, mechanical digital, mechanical drive and audio)
- Choice of non-adjustable 3.3 or 5 V microcontroller supply (REG2) versions reducing risk of overvoltage damage
- Choice of non-adjustable 3.3 or 5 V digital signal processor supply (REG3) versions reducing risk of overvoltage damage
- Selectable output voltages for regulators 1, 4 and 5
- Low dropout voltage PNP output stages
- High supply voltage ripple rejection
- Low noise for all regulators
- Two power switches (antenna switch and amplifier switch)
- Regulator 2 (microcontroller supply) operational during load-dump and thermal shut-down
- Low quiescent current (only regulator 2 is operational)
- Reset output (push-pull output stage)
- Adjustable reset delay time
- Backup functionality.



PROTECTION

- If connection to the battery voltage is reversed, all regulator voltages will be zero
- Able to withstand voltages at the output of up to 18 V (supply line may be short-circuited)
- Thermal protection to avoid thermal breakdown
- Load-dump protection
- Regulator outputs protected from DC short-circuit to ground or to supply voltage
- All regulators protected by foldback current limiting
- Power switches protected from loss-of-ground.

APPLICATIONS

- Boost amplifier and voltage regulator for car radios and CD/MD players.

GENERAL DESCRIPTION

Amplifiers

The TDA8588 has a complementary quad audio power amplifier that uses BCDMOS technology. It contains four amplifiers configured in Bridge Tied Load (BTL) to drive speakers for front and rear left and right channels. The I²C-bus allows diagnostic information of each amplifier and its speaker to be read separately. Both front and both rear channel amplifiers can be configured independently in line driver mode with a gain of 20 dB (differential output).

Voltage regulators

The TDA8588 has a multiple output voltage regulator with two power switches.

The voltage regulator contains the following:

- Four switchable regulators and one permanently active regulator (microcontroller supply)
- Two power switches with loss-of-ground protection
- A reset output that can be used to communicate with a microcontroller.

The quiescent current has a very low level of 150 μA with only regulator 2 active.

I²C-bus controlled 4 × 50 Watt power amplifier and multiple voltage regulator

TDA8588J; TDA8588xJ

QUICK REFERENCE DATA

SYMBOL	PARAMETER	CONDITIONS	MIN.	TYP.	MAX.	UNIT
Amplifiers						
V _{P1} , V _{P2}	operating supply voltage		8	14.4	18	V
I _{q(tot)}	total quiescent current		–	270	400	mA
P _{o(max)}	maximum output power	R _L = 4 Ω; V _P = 14.4 V; V _{IN} = 2 V RMS square wave	44	46	–	W
		R _L = 4 Ω; V _P = 15.2 V; V _{IN} = 2 V RMS square wave	49	52	–	W
		R _L = 2 Ω; V _P = 14.4 V; V _{IN} = 2 V RMS square wave	83	87	–	W
THD	total harmonic distortion		–	0.01	0.1	%
V _{n(o)(amp)}	noise output voltage in amplifier mode		–	50	70	μV
V _{n(o)(LN)}	noise output voltage in line driver mode		–	25	35	μV
Voltage regulators						
SUPPLY						
V _P	supply voltage	regulator 1, 3, 4 and 5 on	10	14.4	18	V
		regulator 2 on	4	–	–	V
		jump starts for t ≤ 10 minutes	–	–	30	V
		load dump protection for t ≤ 50 ms and t _r ≤ 2.5 ms	–	–	50	V
		overvoltage for shut-down	20	–	–	V
I _{q(tot)}	total quiescent supply current	standby mode; V _P = 14.4 V	–	150	190	μA
VOLTAGE REGULATORS						
V _{O(REG1)}	output voltage of regulator 1	0.5 mA ≤ I _O ≤ 400 mA; selectable via I ² C-bus IB2[D3:D2] = 01	–	8.3	–	V
		IB2[D3:D2] = 10	–	8.5	–	V
		IB2[D3:D2] = 11	–	8.7	–	V
V _{O(REG2)}	output voltage of regulator 2	0.5 mA ≤ I _O ≤ 350 mA TDA8588J; TDA8588AJ	–	5.0	–	V
		TDA8588BJ	–	3.3	–	V
V _{O(REG3)}	output voltage of regulator 3	0.5 mA ≤ I _O ≤ 300 mA TDA8588J	–	5.0	–	V
		TDA8588AJ; TDA8588BJ	–	3.3	–	V
V _{O(REG4)}	output voltage of regulator 4	maximum current ≥ 1.6 A; 0.5 mA ≤ I _O ≤ 800 mA; selectable via I ² C-bus IB2[D7:D5] = 001	–	5.0	–	V
		IB2[D7:D5] = 010	–	6.0	–	V
		IB2[D7:D5] = 011	–	7.0	–	V
		IB2[D7:D5] = 100	–	8.6	–	V

I²C-bus controlled 4 × 50 Watt power amplifier and multiple voltage regulator

TDA8588J; TDA8588xJ

SYMBOL	PARAMETER	CONDITIONS	MIN.	TYP.	MAX.	UNIT
V _{O(REG5)}	output voltage of regulator 5	0.5 mA ≤ I _O ≤ 400 mA; selectable via I ² C-bus IB1[D7:D4] = 0001 IB1[D7:D4] = 0010 IB1[D7:D4] = 0011 IB1[D7:D4] = 0100 IB1[D7:D4] = 0101 IB1[D7:D4] = 0110 IB1[D7:D4] = 0111 IB1[D7:D4] = 1000 IB1[D7:D4] = 1001	–	6.0	–	V
			–	7.0	–	V
			–	8.2	–	V
			–	9.0	–	V
			–	9.5	–	V
			–	10.0	–	V
			–	10.4	–	V
			–	12.5	–	V
			–	V _P – 1	–	V
POWER SWITCHES						
V _{drop(SW1)}	dropout voltage of switch 1	I _O = 400 mA	–	0.6	1.1	V
V _{drop(SW2)}	dropout voltage of switch 2	I _O = 400 mA	–	0.6	1.1	V

ORDERING INFORMATION

TYPE NUMBER	PACKAGE			OUTPUT VOLTAGE ⁽¹⁾	
	NAME	DESCRIPTION	VERSION	REGULATOR 2	REGULATOR 3
TDA8588J	DBS37P	plastic DIL-bent-SIL power package; 37 leads (lead length 6.8 mm)	SOT725-1	5 V	5 V
TDA8588AJ				5 V	3.3 V
TDA8588BJ				3.3 V	3.3 V

Note

1. Permanent output voltage of regulator 2 and output voltage of regulator 3, respectively.

I²C-bus controlled 4 × 50 Watt power amplifier and multiple voltage regulator

TDA8588J; TDA8588xJ

BLOCK DIAGRAM

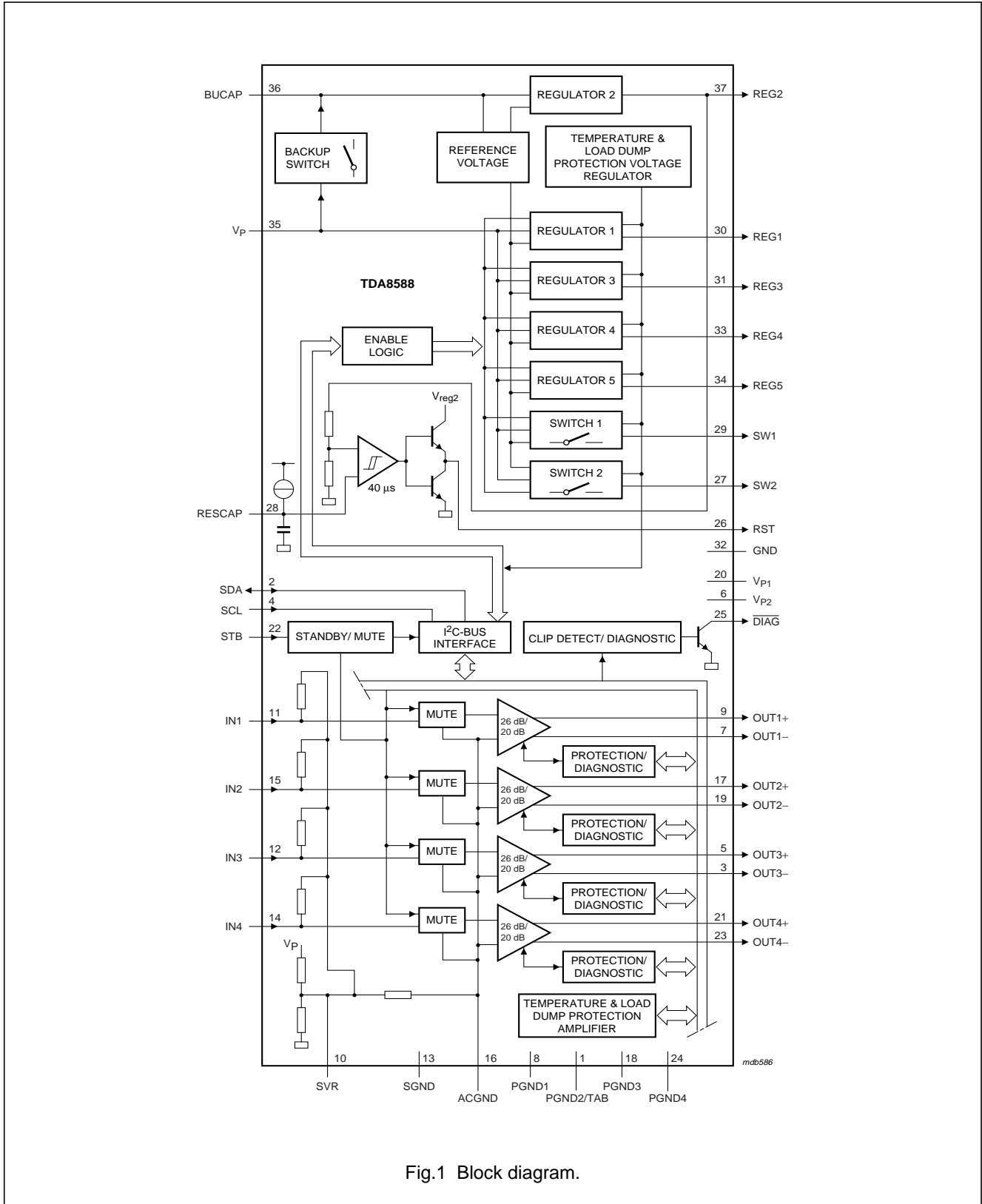

Fig.1 Block diagram.

I²C-bus controlled 4 × 50 Watt power amplifier and multiple voltage regulator

TDA8588J; TDA8588xJ

PINNING

SYMBOL	PIN	DESCRIPTION
PGND2/TAB	1	power ground 2 and connection for heatsink
SDA	2	I ² C-bus data input and output
OUT3-	3	channel 3 negative output
SCL	4	I ² C-bus clock input
OUT3+	5	channel 3 positive output
V _{P2}	6	power supply voltage 2 to amplifier
OUT1-	7	channel 1 negative output
PGND1	8	power ground 1
OUT1+	9	channel 1 positive output
SVR	10	half supply voltage filter capacitor
IN1	11	channel 1 input
IN3	12	channel 3 input
SGND	13	signal ground
IN4	14	channel 4 input
IN2	15	channel 2 input
ACGND	16	AC ground
OUT2+	17	channel 2 positive output
PGND3	18	power ground 3
OUT2-	19	channel 2 negative output
V _{P1}	20	power supply voltage 1 to amplifier
OUT4+	21	channel 4 positive output
STB	22	standby or operating or mute mode select input
OUT4-	23	channel 4 negative output
PGND4	24	power ground 4
DIAG	25	diagnostic and clip detection output, active LOW
RST	26	reset output
SW2	27	antenna switch; supplies unregulated power to car aerial motor
RESCAP	28	reset delay capacitor
SW1	29	amplifier switch; supplies unregulated power to amplifier(s)
REG1	30	regulator 1 output; supply for audio part of radio and CD player
REG3	31	regulator 3 output; supply for signal processor part (mechanical digital) of CD player
GND	32	combined voltage regulator, power and signal ground
REG4	33	regulator 4 output; supply for mechanical part (mechanical drive) of CD player
REG5	34	regulator 5 output; supply for display part of radio and CD player
V _P	35	power supply to voltage regulator
BUCAP	36	connection for backup capacitor
REG2	37	regulator 2 output; supply voltage to microcontroller

I²C-bus controlled 4 × 50 Watt power amplifier and multiple voltage regulator

TDA8588J; TDA8588xJ

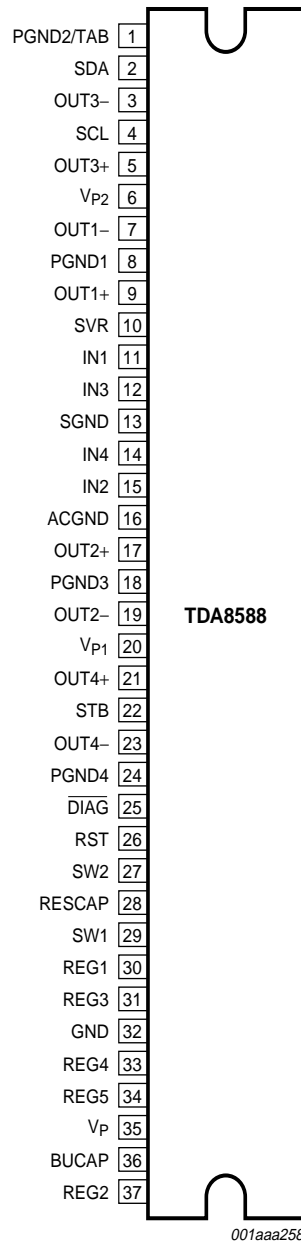

Fig.2 Pin configuration.

I²C-bus controlled 4 × 50 Watt power amplifier and multiple voltage regulator

TDA8588J; TDA8588xJ

FUNCTIONAL DESCRIPTION

The TDA8588 is a multiple voltage regulator combined with four independent audio power amplifiers configured in bridge tied load with diagnostic capability. The output voltages of all regulators except regulators 2 and 3 can be controlled via the I²C-bus. However, regulator 3 can be set to 0 V via the I²C-bus. The output voltage of regulator 2 (microcontroller supply) and the maximum output voltage of regulator 3 (mechanical digital and microcontroller supplies) can both be either 5 V or 3.3 V depending on the type number. The maximum output voltages of both regulators are fixed to avoid any risk of damaging the microcontroller that may occur during a disturbance of the I²C-bus.

The amplifier diagnostic functions give information about output offset, load, or short-circuit. Diagnostic functions are controlled via the I²C-bus. The TDA8588 is protected against short-circuit, over-temperature, open ground and open V_P connections. If a short-circuit occurs at the input or output of a single amplifier, that channel shuts down, and the other channels continue to operate normally. The channel that has a short-circuit can be disabled by the microcontroller via the appropriate enable bit of the I²C-bus to prevent any noise generated by the fault condition from being heard.

Start-up

At power on, regulator 2 will reach its final voltage when the backup capacitor voltage exceeds 5.5 V independently of the voltage on pin STB. When pin STB is LOW, the total quiescent current is low, and the I²C-bus lines are high impedance.

When pin STB is HIGH, the I²C-bus is biased on and then the TDA8588 performs a power-on reset. When bit D0 of instruction byte IB1 is set, the amplifier is activated, bit D7 of data byte 2 (power-on reset occurred) is reset, and pin $\overline{\text{DIAG}}$ is no longer held LOW.

Start-up and shut-down timing (see Fig.12)

A capacitor connected to pin SVR enables smooth start-up and shut-down, preventing the amplifier from producing audible clicks at switch-on or switch-off. The start-up and shut-down times can be extended by increasing the capacitor value.

If the amplifier is shut down using pin STB, the amplifier is muted, the regulators and switches are switched off, and the capacitor connected to pin SVR discharges. The low current standby mode is activated 2 seconds after pin STB goes LOW.

Power-on reset and supply voltage spikes (see Fig.13 and Fig.14)

If the supply voltage drops too low to guarantee the integrity of the data in the I²C-bus latches, the power-on reset cycle will start. All latches will be set to a pre-defined state, pin $\overline{\text{DIAG}}$ will be pulled LOW to indicate that a power-on reset has occurred, and bit D7 of data byte 2 is also set for the same reason. When D0 of instruction byte 1 is set, the power-on flag resets, pin $\overline{\text{DIAG}}$ is released and the amplifier will then enter its start-up cycle.

Diagnostic output

Pin $\overline{\text{DIAG}}$ indicates clipping, thermal protection pre-warning of amplifier and voltage regulator sections, short-circuit protection, low and high battery voltage. Pin $\overline{\text{DIAG}}$ is an open-drain output, is active LOW, and must be connected to an external voltage via an external pull-up resistor. If a failure occurs, pin $\overline{\text{DIAG}}$ remains LOW during the failure and no clipping information is available. The microcontroller can read the failure information via the I²C-bus.

AMPLIFIERS

Muting

A hard mute and a soft mute can both be performed via the I²C-bus. A hard mute mutes the amplifier within 0.5 ms. A soft mute mutes the amplifier within 20 ms and is less audible. A hard mute is also activated if a voltage of 8 V is applied to pin STB.

Temperature protection

If the average junction temperature rises to a temperature value that has been set via the I²C-bus, a thermal protection pre-warning is activated making pin $\overline{\text{DIAG}}$ LOW. If the temperature continues to rise, all four channels will be muted to reduce the output power (soft thermal clipping). The value at which the temperature mute control activates is fixed; only the temperature at which the thermal protection pre-warning signal occurs can be specified by bit D4 in instruction byte 3. If implementing the temperature mute control does not reduce the average junction temperature, all the power stages will be switched off (muted) at the absolute maximum temperature T_{J(max)}.

Offset detection

Offset detection can only be performed when there is no input signal to the amplifiers, for instance when the external digital signal processor is muted after a start-up. The output voltage of each channel is measured and

I²C-bus controlled 4 × 50 Watt power amplifier and multiple voltage regulator

TDA8588J; TDA8588xJ

compared with a reference voltage. If the output voltage of a channel is greater than the reference voltage, bit D2 of the associated data byte is set and read by the microcontroller during a read instruction. Note that the value of this bit is only meaningful when there is no input signal and the amplifier is not muted. Offset detection is always enabled.

Speaker protection

If one side of a speaker is connected to ground, a missing current protection is implemented to prevent damage to the speaker. A fault condition is detected in a channel when there is a mismatch between the power current in the high side and the power current in the low side; during a fault condition the channel will be switched off.

The load status of each channel can be read via the I²C-bus: short to ground (one side of the speaker connected to ground), short to V_P (one side of the speaker connected to V_P), and shorted load.

Line driver mode

An amplifier can be used as a line driver by switching it to low gain mode. In normal mode, the gain between single-ended input and differential output (across the load) is 26 dB. In low gain mode the gain between single-ended input and differential output is 20 dB.

Input and AC ground capacitor values

The negative inputs to all four amplifier channels are combined at pin ACGND. To obtain the best performance for supply voltage ripple rejection and unwanted audible noise, the value of the capacitor connected to pin ACGND must be as close as possible to 4 times the value of the input capacitor connected to the positive input of each channel.

Load detection

DC-LOAD DETECTION

When DC-load detection is enabled, during the start-up cycle, a DC-offset is applied slowly to the amplifier outputs, and the output currents are measured. If the output current of an amplifier rises above a certain level, it is assumed that there is a load of less than 6 Ω and bit D5 is reset in the associated data byte register to indicate that a load is detected.

Because the offset is measured during the amplifier start-up cycle, detection is inaudible and can be performed every time the amplifier is switched on.

AC-LOAD DETECTION

AC-load detection can be used to detect that AC-coupled speakers are connected correctly during assembly. This requires at least 3 periods of a 19 kHz sine wave to be applied to the amplifier inputs. The amplifier produces a peak output voltage which also generates a peak output current through the AC-coupled speaker. The 19 kHz sine wave is also audible during the test. If the amplifier detects three current peaks that are greater than 550 mA, the AC-load detection bit D1 of instruction byte IB1 is set to logic 1. Three current peaks are counted to avoid false AC-load detection which can occur if the input signal is switched on and off. The peak current counter can be reset by setting bit D1 of instruction byte IB1 to logic 0. To guarantee AC-load detection, an amplifier current of more than 550 mA is required. AC-load detection will never occur with a current of less than 150 mA. Figure 3 shows which AC loads are detected at different output voltages. For example, if a load is detected at an output voltage of 2.5 V peak, the load is less than 4 Ω. If no load is detected, the output impedance is more than 14 Ω.

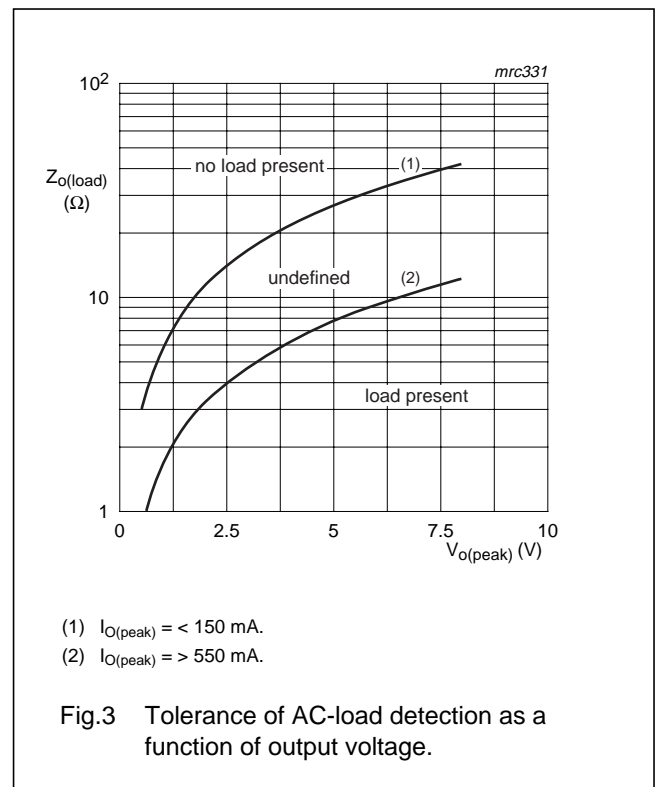

LOAD DETECTION PROCEDURE

- At start-up, enable the AC- or DC-load detection by setting D1 of instruction byte 1 to logic 1.

I²C-bus controlled 4 × 50 Watt power amplifier and multiple voltage regulator

TDA8588J; TDA8588xJ

- 2. After 250 ms the DC load is detected and the mute is released. This is inaudible and can be implemented each time the IC is powered on.
- 3. When the amplifier start-up cycle is completed (after 1.5 s), apply an AC signal to the input, and DC-load bits D5 of each data byte should be read and stored by the microcontroller.
- 4. After at least 3 periods of the input signal, the load status can be checked by reading AC-detect bits D4 of each data byte.

The AC-load peak current counter can be reset by setting bit D1 of instruction byte IB1 to logic 0 and then to logic 1. Note that this will also reset the DC-load detection bits D5 in each data byte.

The headroom voltage is the voltage required for correct operation of the amplifier and is defined as the voltage difference between the level of the DC output voltage before the V_P voltage drop and the level of V_P after the voltage drop (see Fig.4).

At a certain supply voltage drop, the headroom voltage will be insufficient for correct operation of the amplifier. To prevent unwanted audible noises at the output, the headroom protection mode will be activated (see Fig.4). This protection discharges the capacitors connected to pins SVR and ACGND to increase the headroom voltage.

Low headroom protection

The normal DC output voltage of the amplifier is set to half the supply voltage and is related to the voltage on pin SVR. An external capacitor is connected to pin SVR to suppress power supply ripple. If the supply voltage drops (at vehicle engine start), the DC output voltage will follow slowly due to the affect of the SVR capacitor.

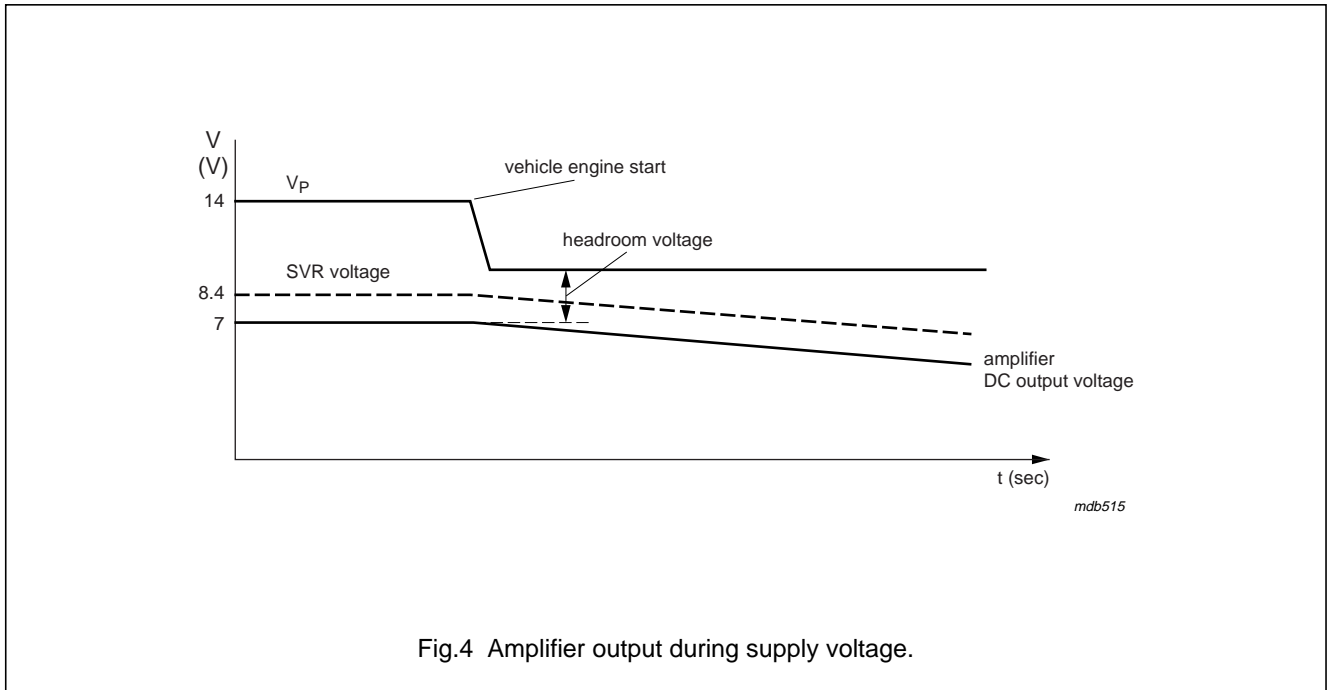

Fig.4 Amplifier output during supply voltage.

I²C-bus controlled 4 × 50 Watt power amplifier and multiple voltage regulator

TDA8588J; TDA8588xJ

VOLTAGE REGULATORS

The voltage regulator section contains:

- Four switchable regulators and one permanent active regulator
- Two power switches with loss-of-ground protection
- Reset push-pull output
- Backup functionality.

The quiescent current condition has a very low current level of 150 μ A typical with only regulator 2 active. The TDA8588 uses low dropout voltage regulators for use in low voltage applications.

All of the voltage regulators except for the standby regulator can be controlled via the I²C-bus. The voltage regulator section of this device has two power switches which are capable of delivering unregulated 400 mA continuous current, and has several fail-safe protection modes. It conforms to peak transient tests and protects against continuous high voltage (24 V), short-circuits and thermal stress. A reset warning signal is asserted if regulator 2 is out of regulation. Regulator 2 will try to maintain output for as long as possible even if a thermal shut-down or any other fault condition occurs. During overvoltage stress conditions, all outputs except regulator 2 will switch off and the device will be able to supply a minimum current for an indefinite amount of time sufficient for powering the memory of a microcontroller. Provision is made for an external reserve supply capacitor to be connected to pin BUCAP which can store enough energy to allow regulator 2 to supply a microcontroller for a period long enough for it to prepare for a loss-of-voltage.

Regulator 2

Regulator 2 is intended to supply the microcontroller and has a low quiescent current. This supply cannot be shut down in response to overvoltage stress conditions, and is not I²C-bus controllable to prevent the microcontroller from being damaged by overvoltage which could occur during a disturbance of the I²C-bus. This supply will not shut down during load dump transients or during a high thermal-protection condition.

Backup capacitor

The backup capacitor is used as a backup supply for the regulator 2 output when the battery supply voltage (V_P) cannot support the regulator 2 voltage.

Backup function

The backup function is implemented by a switch function, which behaves like an ideal diode between pins V_P and BUCAP; the forward voltage of this ideal diode depends on the current flowing through it. The backup function supplies regulator 2 during brief periods when no supply voltage is present on pin V_P . It requires an external capacitor to be connected to pin BUCAP and ground. When the supply voltage is present on pin V_P this capacitor will be charged to a level of $V_P - 0.3$ V. When the supply voltage is absent from pin V_P , this charge can then be used to supply regulator 2 for a brief period (t_{backup}) calculated using the formula:

$$t_{\text{backup}} = C_{\text{backup}} \times R_L \times \left(\frac{V_P - (V_{O(\text{REG2})} - 0.5)}{V_{O(\text{REG2})}} \right)$$

Example: $V_P = 14.4$ V, $V_{O(\text{REG2})} = 5$ V, $R_L = 1$ k Ω and $C_{\text{backup}} = 100$ μ F provides a t_{backup} of 177 ms.

When an overvoltage condition occurs, the voltage on pin BUCAP is limited to approximately 24 V; see Fig.5.

I²C-bus controlled 4 × 50 Watt power amplifier and multiple voltage regulator

TDA8588J; TDA8588xJ

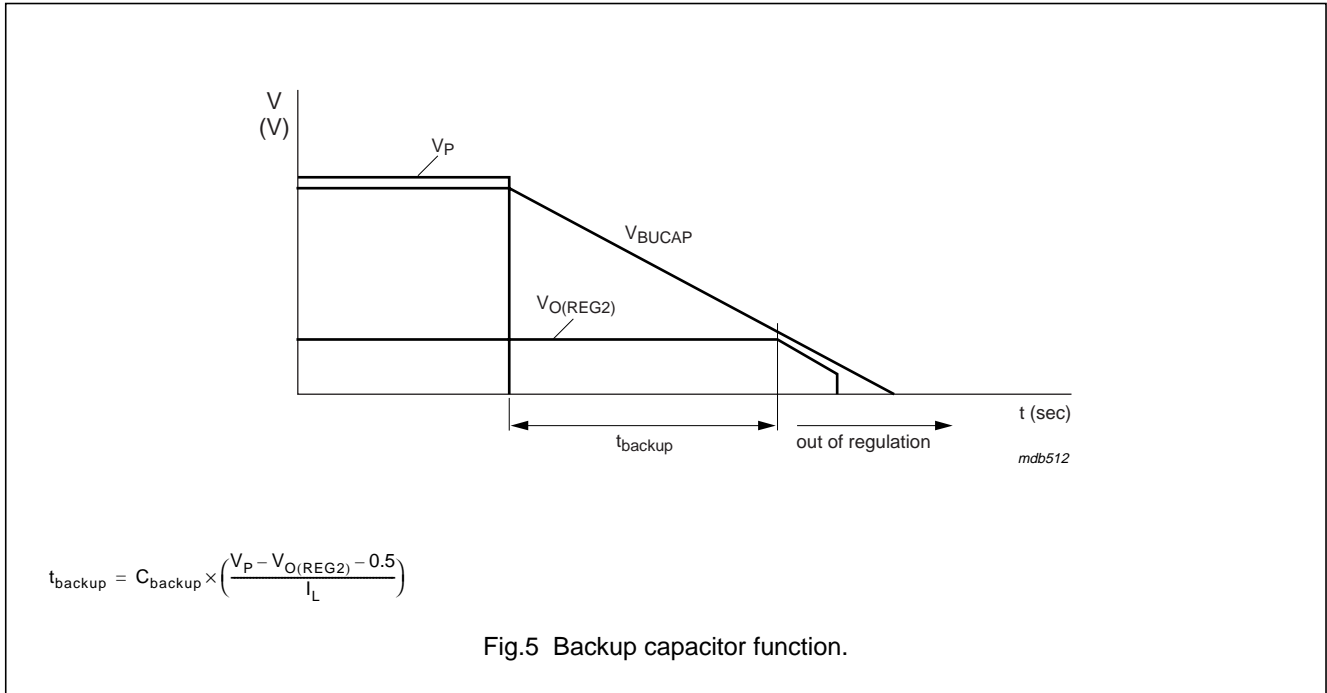

Reset output

A reset pulse is generated at pin RST when the output voltage of regulator 2 rises above the reset threshold value. The reset output is a push-pull output that both sources and sinks current. The output voltage can switch between ground and $V_{O(\text{REG}2)}$, and operates at a low regulator 2 voltage or V_{BUCAP} . The RST signal is controlled by a low-voltage detection circuit which, when activated, pulls pin RST LOW (reset active) when $V_{O(\text{REG}2)}$ is $\leq V_{\text{th}(\text{rst})}$. If $V_{O(\text{REG}2)} \geq V_{\text{th}(\text{rst})}$, pin RST goes HIGH. The reset pulse is delayed by 40 μs internally. To extend the delay and to prevent oscillations occurring at the threshold voltage, an external capacitor can be connected to pin RESCAP. Note that a reset pulse is not generated when $V_{O(\text{REG}2)}$ falls below the reset threshold value.

Reset delay capacitor

A Reset Delay Capacitor (RDC) connected to pin RESCAP can be used to extend the delay period of the reset pulse and to ensure that a clean reset signal is sent to the microcontroller. The RDC is charged by a current source. The reset output (pin RST) will be released (pin RST goes HIGH) when the RDC voltage crosses the RDC threshold value.

Power switches

There are two power switches that provide an unregulated DC voltage output for amplifiers and an aerial motor respectively. The switches have internal protection for over-temperature conditions and are activated by setting bits D2 and D3 of instruction byte IB1 to logic 1. The regulated outputs will supply pulsed current loads that can contaminate the line with high frequency noise, so it is important to prevent any cross-coupling between the regulated outputs, particularly with the 8.3 V audio supply, and the unregulated outputs.

In the ON state, the switches have a low impedance to the battery voltage. When the battery voltage is higher than 22 V, the switches are switched off. When the battery voltage is below 22 V the switches are set to their original condition.

I²C-bus controlled 4 × 50 Watt power amplifier and multiple voltage regulator

TDA8588J; TDA8588xJ

Protection

All regulator and switch outputs are fully protected by foldback current limiting against load dumps and short-circuits; see Fig.6. During a load dump all regulator outputs, except the output of regulator 2, will go low.

The power switches can withstand 'loss-of-ground'. This means that if pin GND becomes disconnected, the switch is protected by automatically connecting its outputs to ground.

Temperature protection

If the junction temperature of a regulator becomes too high, the amplifier(s) are switched off to prevent unwanted noise signals being audible. A regulator junction temperature that is too high is indicated by pin $\overline{\text{DIAG}}$ going LOW and is also indicated by setting bit D6 in data byte 2.

If the junction temperature of the regulator continues to rise and reaches the maximum temperature protection level, all regulators and switches will be disabled except regulator 2.

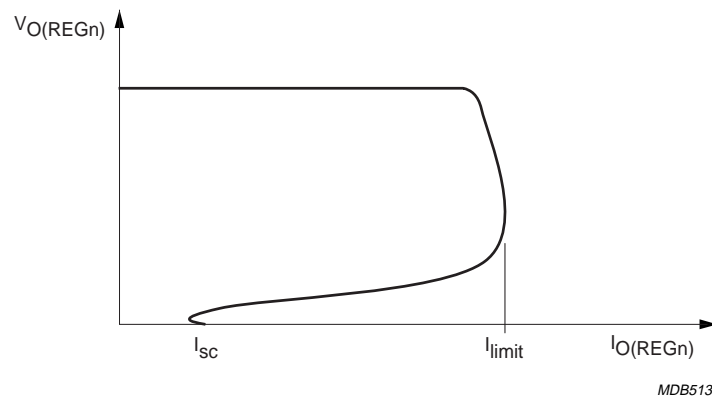

Fig.6 Foldback current protection.

I²C-bus controlled 4 × 50 Watt power amplifier and multiple voltage regulator

TDA8588J; TDA8588xJ

I²C-BUS SPECIFICATION

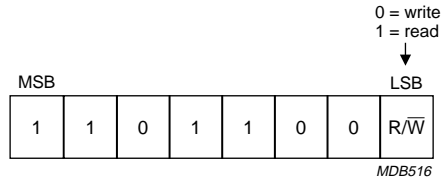

Fig.7 Address byte.

If address byte bit $R/\overline{W} = 0$, the TDA8588 expects 3 instruction bytes: IB1, IB2 and IB3; see Table 1 to Table 6.

After a power-on, all instruction bits are set to zero.

If address byte bit $R/\overline{W} = 1$, the TDA8588 will send 4 data bytes to the microcontroller: DB1, DB2, DB3 and DB4; see Table 7 to Table 10.

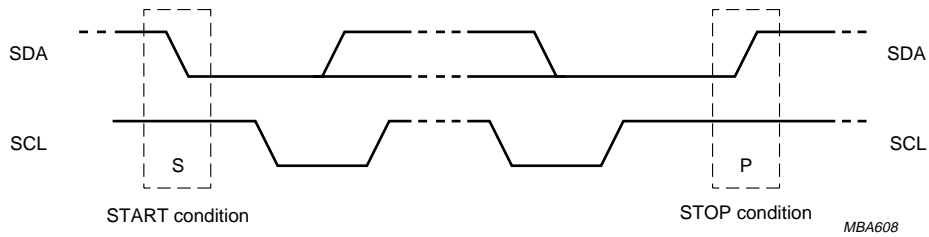

Fig.8 Definition of start and stop conditions.

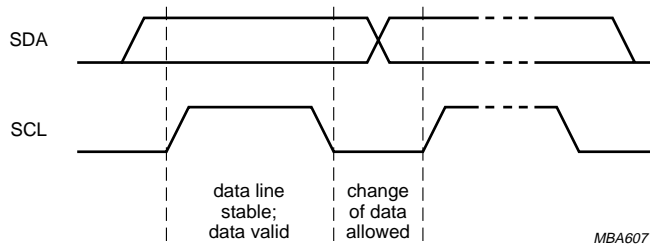

Fig.9 Bit transfer.

I²C-bus controlled 4 × 50 Watt power amplifier and multiple voltage regulator

TDA8588J; TDA8588xJ

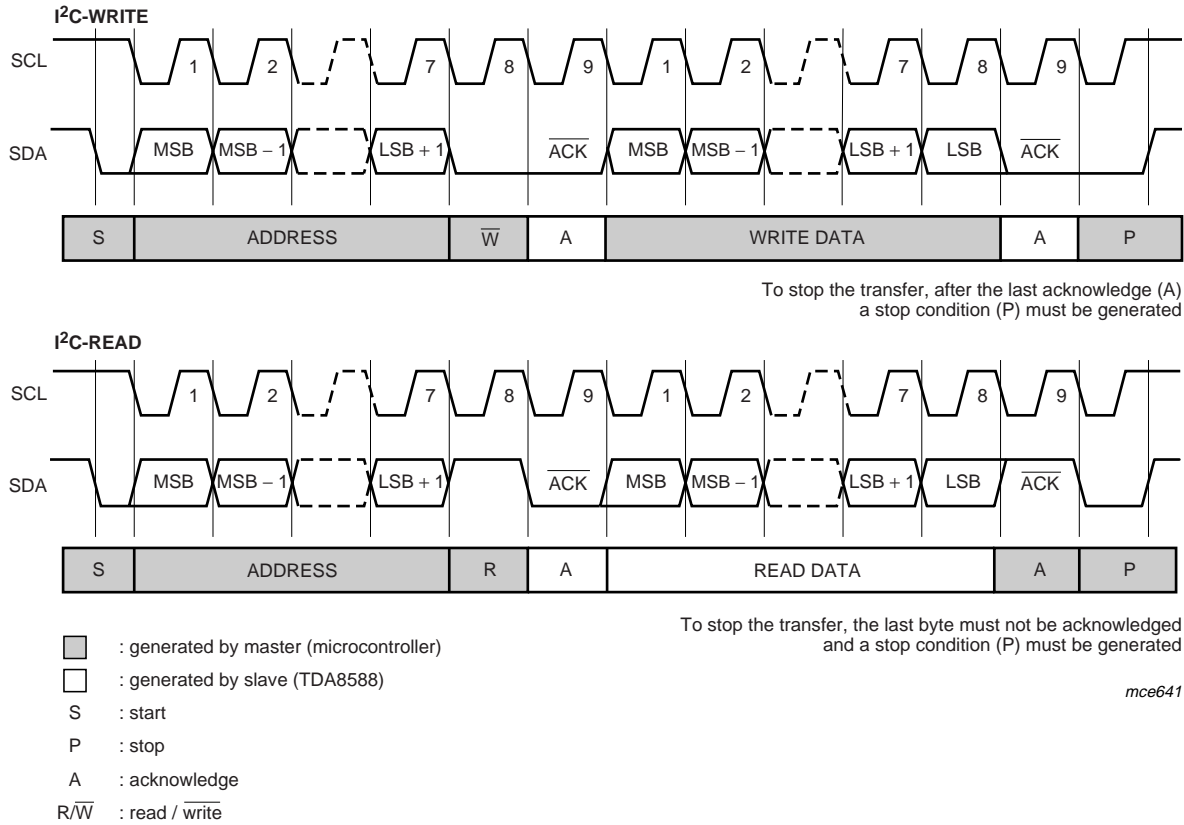

Fig.10 I²C-bus read and write modes.

I²C-bus controlled 4 × 50 Watt power amplifier and multiple voltage regulator

TDA8588J; TDA8588xJ

Table 1 Instruction byte IB1

BIT	DESCRIPTION
D7	regulator 5 output voltage control (see Table 2)
D6	
D5	
D4	
D3	SW2 control 0 = SW2 off 1 = SW2 on
D2	SW1 control 0 = SW1 off 1 = SW1 on
D1	AC- or DC-load detection switch 0 = AC- or DC-load detection off; resets DC-load detection bits and AC-load detection peak current counter 1 = AC- or DC-load detection on
D0	amplifier start enable (clear power-on reset flag; D7 of DB2) 0 = amplifier OFF; pin $\overline{\text{DIAG}}$ remains LOW 1 = amplifier ON; when power-on occurs, bit D7 of DB2 is reset and pin $\overline{\text{DIAG}}$ is released

Table 2 Regulator 5 (display) output voltage control

BIT				OUTPUT (V)
D7	D6	D5	D4	
0	0	0	0	0 (off)
0	0	0	1	6.0
0	0	1	0	7.0
0	0	1	1	8.2
0	1	0	0	9.0
0	1	0	1	9.5
0	1	1	0	10.0
0	1	1	1	10.4
1	0	0	0	12.5
1	0	0	1	$\leq V_P - 1$ (switch)

Table 3 Instruction byte IB2

BIT	DESCRIPTION
D7	regulator 4 output voltage control (see Table 4)
D6	
D5	
D4	regulator 3 (mechanical digital) control 0 = regulator 3 off 1 = regulator 3 on
D3	regulator 1 output voltage control (see Table 5)
D2	
D1	soft mute all amplifier channels (mute delay 20 ms) 0 = mute off 1 = mute on
D0	hard mute all amplifier channels (mute delay 0.4 ms) 0 = mute off 1 = mute on

Table 4 Regulator 4 (mechanical drive) output voltage control

BIT			OUTPUT (V)
D7	D6	D5	
0	0	0	0 (off)
0	0	1	5
0	1	0	6
0	1	1	7
1	0	0	8.6

Table 5 Regulator 1 (audio) output voltage control

BIT		OUTPUT (V)
D3	D2	
0	0	0 (off)
0	1	8.3
1	0	8.5
1	1	8.7

I²C-bus controlled 4 × 50 Watt power amplifier and multiple voltage regulator

TDA8588J; TDA8588xJ

Table 6 Instruction byte IB3

BIT	DESCRIPTION
D7	clip detection level 0 = 4 % detection level 1 = 1 % detection level
D6	amplifier channels 1 and 2 gain select 0 = 26 dB gain (normal mode) 1 = 20 dB gain (line driver mode)
D5	amplifier channels 3 and 4 gain select 0 = 26 dB gain (normal mode) 1 = 20 dB gain (line driver mode)
D4	amplifier thermal protection pre-warning 0 = warning at 145 °C 1 = warning at 122 °C
D3	disable channel 1 0 = enable channel 1 1 = disable channel 1
D2	disable channel 2 0 = enable channel 2 1 = disable channel 2
D1	disable channel 3 0 = enable channel 3 1 = disable channel 3
D0	disable channel 4 0 = enable channel 4 1 = disable channel 4

Table 7 Data byte DB1

BIT	DESCRIPTION
D7	amplifier thermal protection pre-warning 0 = no warning 1 = junction temperature above pre-warning level
D6	amplifier maximum thermal protection 0 = junction temperature below 175 °C 1 = junction temperature above 175 °C
D5	channel 4 DC load detection 0 = DC load detected 1 = no DC load detected
D4	channel 4 AC load detection 0 = no AC load detected 1 = AC load detected
D3	channel 4 load short-circuit 0 = normal load 1 = short-circuit load
D2	channel 4 output offset 0 = no output offset 1 = output offset
D1	channel 4 V _P short-circuit 0 = no short-circuit to V _P 1 = short-circuit to V _P
D0	channel 4 ground short-circuit 0 = no short-circuit to ground 1 = short-circuit to ground

I²C-bus controlled 4 × 50 Watt power amplifier and multiple voltage regulator

TDA8588J; TDA8588xJ

Table 8 Data byte DB2

BIT	DESCRIPTION
D7	Power-on reset occurred or amplifier status 0 = amplifier on 1 = POR has occurred; amplifier off
D6	regulator thermal protection pre-warning 0 = no warning 1 = regulator temperature too high; amplifier off
D5	channel 3 DC load detection 0 = DC load detected 1 = no DC load detected
D4	channel 3 AC load detection 0 = no AC load detected 1 = AC load detected
D3	channel 3 load short-circuit 0 = normal load 1 = short-circuit load
D2	channel 3 output offset 0 = no output offset 1 = output offset
D1	channel 3 V _P short-circuit 0 = no short-circuit to V _P 1 = short-circuit to V _P
D0	channel 3 ground short-circuit 0 = no short-circuit to ground 1 = short-circuit to ground

Table 9 Data byte DB3

BIT	DESCRIPTION
D7	–
D6	–
D5	channel 2 DC load detection 0 = DC load detected 1 = no DC load detected
D4	channel 2 AC load detection 0 = no AC load detected 1 = AC load detected
D3	channel 2 load short-circuit 0 = normal load 1 = short-circuit load
D2	channel 2 output offset 0 = no output offset 1 = output offset
D1	channel 2 V _P short-circuit 0 = no short-circuit to V _P 1 = short-circuit to V _P
D0	channel 2 ground short-circuit 0 = no short-circuit to ground 1 = short-circuit to ground

I²C-bus controlled 4 × 50 Watt power amplifier and multiple voltage regulator

TDA8588J; TDA8588xJ

Table 10 Data byte DB4

BIT	DESCRIPTION
D7	–
D6	–
D5	channel 1 DC load detection 0 = DC load detected 1 = no DC load detected
D4	channel 1 AC load detection 0 = no AC load detected 1 = AC load detected
D3	channel 1 load short-circuit 0 = normal load 1 = short-circuit load
D2	channel 1 output offset 0 = no output offset 1 = output offset
D1	channel 1 V _P short-circuit 0 = no short-circuit to V _P 1 = short-circuit to V _P
D0	channel 1 ground short-circuit 0 = no short-circuit to ground 1 = short-circuit to ground

I²C-bus controlled 4 × 50 Watt power amplifier and multiple voltage regulator

TDA8588J; TDA8588xJ

LIMITING VALUES

In accordance with the Absolute Maximum Rating System (IEC 60134).

SYMBOL	PARAMETER	CONDITION	MIN.	MAX.	UNIT
V _P	supply voltage	operating	–	18	V
		not operating	–1	+50	V
		with load dump protection	0	50	V
V _{SDA} , V _{SCL}	voltage on pins SDA and SCL	operating	0	7	V
V _{IN} , V _{SVR} , V _{ACGND} , V _{DIAG}	voltage on pins INn, SVR, ACGND and DIAG	operating	0	13	V
V _{STB}	voltage on pin STB	operating	0	24	V
I _{OSM}	non-repetitive peak output current		–	10	A
I _{ORM}	repetitive peak output current		–	6	A
V _{sc}	AC and DC short-circuit voltage	short-circuit of output pins across loads and to ground or supply	–	18	V
V _{rp}	reverse polarity voltage	voltage regulator only	–	–18	V
P _{tot}	total power dissipation	T _{case} = 70 °C	–	80	W
T _j	junction temperature		–	150	°C
T _{stg}	storage temperature		–55	+150	°C
T _{amb}	ambient temperature		–40	+85	°C
V _{esd}	electrostatic discharge voltage	note 1	–	2000	V
		note 2	–	200	V

Notes

- Human body model: R_s = 1.5 kΩ; C = 100 pF; all pins have passed all tests to 2500 V to guarantee 2000 V, according to class II.
- Machine model: R_s = 10 Ω; C = 200 pF; L = 0.75 mH; all pins have passed all tests to 250 V to guarantee 200 V, according to class II.

I²C-bus controlled 4 × 50 Watt power amplifier and multiple voltage regulator

TDA8588J; TDA8588xJ

THERMAL CHARACTERISTICS

SYMBOL	PARAMETER	CONDITIONS	VALUE	UNIT
R _{th(j-a)}	thermal resistance from junction to ambient	in free air	40	K/W
R _{th(j-c)}	thermal resistance from junction to case	see Fig.11	0.75	K/W

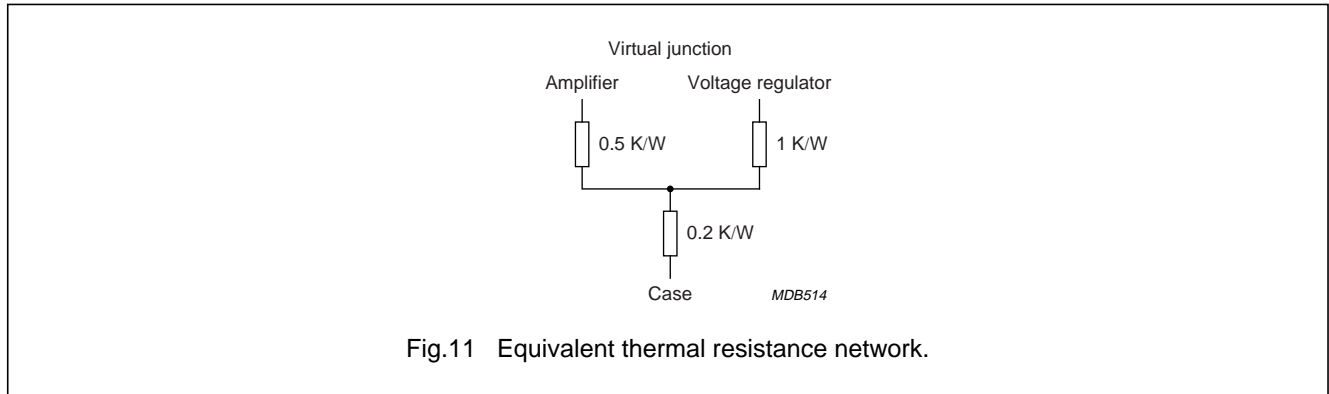

Fig.11 Equivalent thermal resistance network.

QUALITY SPECIFICATION

In accordance with "General Quality Specification for Integrated Circuits SNW-FQ-611D".

I²C-bus controlled 4 × 50 Watt power amplifier and multiple voltage regulator

TDA8588J; TDA8588xJ

CHARACTERISTICS

Amplifier section

$T_{amb} = 25\text{ °C}$; $V_P = 14.4\text{ V}$; $R_L = 4\ \Omega$; measured in the test circuit Fig.26; unless otherwise specified.

SYMBOL	PARAMETER	CONDITION	MIN.	TYP.	MAX.	UNIT
Supply voltage behaviour						
V_{P1}, V_{P2}	operating supply voltage	$R_L = 4\ \Omega$	8	14.4	18	V
		$R_L = 2\ \Omega$	8	14.4	16	V
$I_{q(tot)}$	total quiescent current	no load	–	280	400	mA
I_{stb}	standby current		–	10	50	μA
V_O	DC output voltage		–	7.2	–	V
$V_{P(mute)}$	low supply voltage mute		6.5	7	8	V
V_{hr}	headroom voltage	when headroom protection is activated; see Fig.4	–	1.4	–	V
V_{POR}	power-on reset voltage	see Fig.13	–	5.5	–	V
V_{OO}	output offset voltage	mute mode and power on	–100	0	+100	mV
Mode select (pin STB)						
V_{stb}	standby mode voltage		–	–	1.3	V
V_{oper}	operating mode voltage		2.5	–	5.5	V
V_{mute}	mute mode voltage		8	–	V_P	V
I_I	input current	$V_{STB} = 5\text{ V}$	–	4	25	μA
Start-up, shut-down and mute timing						
t_{wake}	wake-up time from standby before first I ² C-bus transmission is recognised	via pin STB; see Fig.12	–	300	500	μs
$t_{mute(off)}$	time from amplifier switch-on to mute release	via I ² C-bus (IB1 bit D0); $C_{SVR} = 22\ \mu\text{F}$; see Fig.12	–	250	–	ms
$t_{d(mute-on)}$	delay from mute to on	soft mute; via I ² C-bus (IB2 bit D1 = 1 to 0)	10	25	40	ms
		hard mute; via I ² C-bus (IB2 bit D0 = 1 to 0)	10	25	40	ms
		via pin STB; $V_{STB} = 4\text{ to }8\text{ V}$	10	25	40	ms
$t_{d(on-mute)}$	delay from on to mute	soft mute; via I ² C-bus (IB2 bit D1 = 0 to 1)	10	25	40	ms
		hard mute; via I ² C-bus (IB2 bit D0 = 0 to 1)	–	0.4	1	ms
		via pin STB; $V_{STB} = 4\text{ to }8\text{ V}$	–	0.4	1	ms
I²C-bus interface						
V_{IL}	LOW-level input voltage on pins SCL and SDA		–	–	1.5	V
V_{IH}	HIGH-level input voltage on pins SCL and SDA		2.3	–	5.5	V
V_{OL}	LOW-level output voltage on pin SDA	$I_L = 3\text{ mA}$	–	–	0.4	V

I²C-bus controlled 4 × 50 Watt power amplifier and multiple voltage regulator

TDA8588J; TDA8588xJ

SYMBOL	PARAMETER	CONDITION	MIN.	TYP.	MAX.	UNIT
f _{SCL}	SCL clock frequency		–	–	400	kHz
Diagnostic						
V _{DIAG}	diagnostic pin LOW output voltage	fault condition; I _{DIAG} = 200 μA	–	–	0.8	V
V _{o(offset)}	output voltage when offset is detected		± 1.5	± 2	± 2.5	V
THD _{clip}	THD clip detection level	IB3 bit D7 = 0	–	4	–	%
		IB3 bit D7 = 1	–	1	–	%
T _{j(warn)}	average junction temperature for pre-warning	IB3 bit D4 = 0	135	145	155	°C
		IB3 bit D4 = 1	112	122	132	°C
T _{j(mute)}	average junction temperature for 3 dB muting	V _{IN} = 0.05 V	150	160	170	°C
T _{j(off)}	average junction temperature when all outputs are switched off		165	175	185	°C
Z _{o(load)}	impedance when a DC load is detected		–	–	6	Ω
Z _{o(open)}	impedance when an open DC load is detected		500	–	–	Ω
I _{o(load)}	amplifier current when an AC load is detected		550	–	–	mA
I _{o(open)}	amplifier current when an open AC load is detected		–	–	150	mA
Amplifier						
P _o	output power	R _L = 4 Ω; V _P = 14.4 V; THD = 0.5 %	20	21	–	W
		R _L = 4 Ω; V _P = 14.4 V; THD = 10 %	27	28	–	W
		R _L = 4 Ω; V _P = 14.4 V; V _{IN} = 2 V RMS square wave (maximum power)	44	46	–	W
		R _L = 4 Ω; V _P = 15.2 V; V _{IN} = 2 V RMS square wave (maximum power)	49	52	–	W
		R _L = 2 Ω; V _P = 14.4 V; THD = 0.5 %	37	41	–	W
		R _L = 2 Ω; V _P = 14.4 V; THD = 10 %	51	55	–	W
		R _L = 2 Ω; V _P = 14.4 V; V _{IN} = 2 V RMS square wave (maximum power)	83	87	–	W
THD	total harmonic distortion	P _o = 1 W to 12 W; f = 1 kHz; R _L = 4 Ω	–	0.01	0.1	%
		P _o = 1 W to 12 W; f = 10 kHz	–	0.2	0.5	%
		P _o = 4 W; f = 1 kHz	–	0.01	0.03	%
		line driver mode; V _o = 2 V (RMS); f = 1 kHz; R _L = 600 Ω	–	0.01	0.03	%

I²C-bus controlled 4 × 50 Watt power amplifier and multiple voltage regulator

TDA8588J; TDA8588xJ

SYMBOL	PARAMETER	CONDITION	MIN.	TYP.	MAX.	UNIT
α_{cs}	channel separation (crosstalk)	$f = 1 \text{ Hz to } 10 \text{ kHz}; R_{source} = 600 \Omega$	50	60	–	dB
		$P_o = 4 \text{ W}; f = 1 \text{ kHz}$	–	80	–	dB
SVRR	supply voltage ripple rejection	$f = 100 \text{ Hz to } 10 \text{ kHz}; R_{source} = 600 \Omega$	55	70	–	dB
CMRR	common mode ripple rejection	amplifier mode; $V_{common} = 0.3 \text{ V (p-p)};$ $f = 1 \text{ kHz to } 3 \text{ kHz}; R_{source} = 0 \Omega$	40	70	–	dB
$V_{cm(max)(rms)}$	maximum common mode voltage level (rms value)	$f = 1 \text{ kHz}$	–	–	0.6	V
$V_{n(o)(LN)}$	noise output voltage in line driver mode	filter 20 Hz to 22 kHz; $R_{source} = 600 \Omega$	–	25	35	μV
$V_{n(o)(amp)}$	noise output voltage in amplifier mode	filter 20 Hz to 22 kHz; $R_{source} = 600 \Omega$	–	50	70	μV
$G_{V(amp)}$	voltage gain in amplifier mode	single-ended in to differential out	25	26	27	dB
$G_{V(LN)}$	voltage gain in line driver mode	single-ended in to differential out	19	20	21	dB
Z_i	input impedance	$C_{IN} = 220 \text{ nF}$	55	70	–	k Ω
α_{mute}	mute attenuation	$V_{O(on)}/V_{O(mute)}$	80	90	–	dB
$V_{O(mute)}$	output voltage mute	$V_{IN} = 1 \text{ V (RMS)}$	–	70	–	μV
B_p	power bandwidth	–1 dB; THD = 1 %	–	20	–	kHz

Voltage regulator section

$T_{amb} = 25 \text{ }^\circ\text{C}; V_P = 14.4 \text{ V};$ measured in the test circuit Fig.26; unless otherwise specified.

SYMBOL	PARAMETER	CONDITIONS	MIN.	TYP.	MAX.	UNIT
Supply						
V_P	supply voltage	regulator 1, 3, 4 and 5 on	10.0	14.4	18	V
		regulator 2				
		switched on	4	–	–	V
		in regulation	6.3	–	50	V
	overvoltage for shut-down	18.1	22	–	V	
$I_{q(tot)}$	total quiescent supply current	standby mode; note 1	–	150	190	μA
Reset output (push-pull stage, pin RST)						
$V_{REG2(th)(r)}$	rising threshold voltage of regulator 2	V_P is rising; $I_{O(REG2)} = 50 \text{ mA}$	$V_{O(REG2)} - 0.2$	$V_{O(REG2)} - 0.1$	$V_{O(REG2)} - 0.04$	V
$V_{REG2(th)(f)}$	falling threshold voltage of regulator 2	V_P is falling; $I_{O(REG2)} = 50 \text{ mA}$	$V_{O(REG2)} - 0.25$	$V_{O(REG2)} - 0.15$	$V_{O(REG2)} - 0.1$	V
$I_{sink(L)}$	LOW-level sink current	$V_{RST} \leq 0.8 \text{ V}$	1	–	–	mA
$I_{source(H)}$	HIGH-level source current	$V_{RST} = V_{O(REG2)} - 0.5 \text{ V};$ $V_P = 14.4 \text{ V}$	200	600	–	μA
t_r	rise time	note 2	–	2	50	μs
t_f	fall time	note 2	–	10	50	μs

I²C-bus controlled 4 × 50 Watt power amplifier and multiple voltage regulator

TDA8588J; TDA8588xJ

SYMBOL	PARAMETER	CONDITIONS	MIN.	TYP.	MAX.	UNIT
Reset delay (pin RESCAP)						
I _{ch}	charge current	V _{RESCAP} = 0 V	1	4	8	μA
I _{dch}	discharge current	V _{RESCAP} = 3 V; V _P ≥ 4.3 V	1	7	–	mA
V _{th(rst)}	reset signal threshold voltage	TDA8588AJ and TDA8588J	2.5	3	3.5	V
		TDA8588BJ	1.6	2.1	2.6	V
t _{d(rst)}	reset signal delay	without C _{RESCAP} ; note 3	–	40	–	μs
		C _{RESCAP} = 47 nF; note 3; see Fig.15	15	35	100	ms
Regulator 1: REG1 (audio; I_O = 5 mA)						
V _{O(REG1)}	output voltage	0.5 mA ≤ I _O ≤ 400 mA; 12 V < V _P < 18 V; IB2[D3:D2] = 01	7.9	8.3	8.7	V
		IB2[D3:D2] = 10	8.1	8.5	8.9	V
		IB2[D3:D2] = 11	8.3	8.7	9.1	V
V _{O(LN)}	line regulation voltage	12 V ≤ V _P ≤ 18 V	–	–	50	mV
V _{O(load)}	load regulation voltage	5 mA ≤ I _O ≤ 400 mA	–	–	100	mV
SVRR	supply voltage ripple rejection	f _{ripple} = 120 Hz; V _{ripple} = 2 V (p-p)	50	60	–	dB
V _{drop}	dropout voltage	V _P = 7.5 V; note 4 I _O = 200 mA	–	0.4	0.8	V
		I _O = 400 mA	–	0.6	2.5	V
I _{limit}	current limit	V _O ≥ 7 V; note 5	400	700	–	mA
I _{sc}	short-circuit current	R _L ≤ 0.5 Ω; note 6	70	190	–	mA
Regulator 2: REG2 (microprocessor; I_O = 5 mA)						
V _{O(REG2)}	output voltage	0.5 mA ≤ I _O ≤ 350 mA; 10 V ≤ V _P ≤ 18 V TDA8588AJ and TDA8588J	4.75	5.0	5.25	V
		TDA8588BJ	3.1	3.3	3.5	V
V _{O(LN)}	line regulation voltage	10 V ≤ V _P ≤ 18 V	–	3	50	mV
V _{O(load)}	load regulation voltage	0.5 mA ≤ I _O ≤ 300 mA	–	–	100	mV
SVRR	supply voltage ripple rejection	f _{ripple} = 120 Hz; V _{ripple} = 2 V (p-p)	40	50	–	dB

I²C-bus controlled 4 × 50 Watt power amplifier and multiple voltage regulator

TDA8588J; TDA8588xJ

SYMBOL	PARAMETER	CONDITIONS	MIN.	TYP.	MAX.	UNIT
V _{drop}	dropout voltage	I _O = 200 mA V _{BUCAP} = 4.75 V; note 7 TDA8588AJ and TDA8588J	–	0.5	0.8	V
		TDA8588BJ	–	1.75	2	V
		I _O = 350 mA; V _{BUCAP} = 4.75 V; note 7 TDA8588AJ and TDA8588J	–	0.5	1.3	V
		TDA8588BJ	–	1.75	2.7	V
I _{limit}	current limit	V _O ≥ 2.8 V; note 5	400	1000	–	mA
I _{sc}	short-circuit current	R _L ≤ 0.5 Ω; note 6	160	300	–	mA
Regulator 3: REG3 (mechanical digital; I_O = 5 mA)						
V _{O(REG3)}	output voltage	0.5 mA ≤ I _O ≤ 300 mA; 10 V ≤ V _P ≤ 18 V TDA8588AJ and TDA8588BJ	3.1	3.3	3.5	V
		TDA8588J	4.75	5.0	5.25	V
		V _{O(LN)}	line regulation voltage	10 V ≤ V _P ≤ 18 V	–	3
V _{O(load)}	load regulation voltage	0.5 mA ≤ I _O ≤ 300 mA	–	–	100	mV
SVRR	supply voltage ripple rejection	f _{ripple} = 120 Hz; V _{ripple} = 2 V (p-p)	50	65	–	dB
V _{drop}	dropout voltage	V _P = 4.75 V; I _O = 200 mA; note 4 TDA8588AJ and TDA8588BJ	–	1.45	1.65	V
		TDA8588J	–	0.4	0.8	V
		V _P = 4.75 V; I _O = 300 mA; note 4 TDA8588AJ and TDA8588BJ	–	1.45	1.65	V
		TDA8588J	–	0.4	1.5	V
I _{limit}	current limit	V _O ≥ 2.8 V; note 5	400	700	–	mA
I _{sc}	short-circuit current	R _L ≤ 0.5 Ω; note 6	135	210	–	mA
Regulator 4: REG4 (mechanical drive; I_O = 5 mA)						
V _{O(REG4)}	output voltage	0.5 mA ≤ I _O ≤ 800 mA; 10 V ≤ V _P ≤ 18 V IB2[D7:D5] = 001	4.75	5.0	5.25	V
		IB2[D7:D5] = 010	5.7	6.0	6.3	V
		IB2[D7:D5] = 011	6.6	7.0	7.4	V
		IB2[D7:D5] = 100	8.1	8.6	9.1	V
V _{O(LN)}	line regulation voltage	10 V ≤ V _P ≤ 18 V	–	3	50	mV

I²C-bus controlled 4 × 50 Watt power amplifier and multiple voltage regulator

TDA8588J; TDA8588xJ

SYMBOL	PARAMETER	CONDITIONS	MIN.	TYP.	MAX.	UNIT
V _{O(load)}	load regulation voltage	0.5 mA ≤ I _O ≤ 400 mA	–	–	100	mV
SVRR	supply voltage ripple rejection	f _{ripple} = 120 Hz; V _{ripple} = 2 V (p-p)	50	65	–	dB
V _{drop}	dropout voltage	V _P = V _{O(REG4)} – 0.5 V; I _O = 800 mA; note 4	–	0.6	1	V
I _{O(peak)}	peak output current	t ≤ 3 s; V _O = 4 V	1	1.5	–	A
I _{limit}	limit current	V _O ≥ 4 V; t ≤ 100 ms; V _P ≥ 11.5 V; note 5	1.5	2	–	A
I _{sc}	short-circuit current	R _L ≤ 0.5 Ω; note 6	240	400	–	mA
Regulator 5: REG5 (display; I_O = 5 mA)						
V _{O(REG5)}	output voltage	0.5 mA ≤ I _O ≤ 400 mA 10 V ≤ V _P ≤ 18 V; IB1[D7:D4] = 0001	5.7	6.0	6.3	V
		10 V ≤ V _P ≤ 18 V; IB1[D7:D4] = 0010	6.65	7.0	7.37	V
		10 V ≤ V _P ≤ 18 V; IB1[D7:D4] = 0011	7.8	8.2	8.6	V
		10.5 V ≤ V _P ≤ 18 V; IB1[D7:D4] = 0100	8.55	9.0	9.45	V
		11 V ≤ V _P ≤ 18 V; IB1[D7:D4] = 0101	9.0	9.5	10.0	V
		11.5 V ≤ V _P ≤ 18 V; IB1[D7:D4] = 0110	9.5	10.0	10.5	V
		13 V ≤ V _P ≤ 18 V; IB1[D7:D4] = 0111	9.9	10.4	10.9	V
		14.2 V ≤ V _P ≤ 18 V; IB1[D7:D4] = 1000	11.8	12.5	13.2	V
		12.5 V ≤ V _P ≤ 18 V; IB1[D7:D4] = 1001	V _P – 1	–	–	V
		V _{O(LN)}	line regulation voltage	10 V ≤ V _P ≤ 18 V	–	3
V _{O(load)}	load regulation voltage	0.5 mA ≤ I _O ≤ 400 mA	–	–	100	mV
SVRR	supply voltage ripple rejection	f _{ripple} = 120 Hz; V _{ripple} = 2 V (p-p)	50	60	–	dB
V _{drop}	dropout voltage	V _P = V _{O(REG5)} – 0.5 V; note 4 I _O = 300 mA	–	0.4	0.8	V
		I _O = 400 mA	–	0.5	2.3	V
I _{limit}	limit current	V _O ≥ 5.5 V; note 5	400	950	–	mA
I _{sc}	short-circuit current	R _L ≤ 0.5 Ω; note 6	100	200	–	mA
Power switch 1: SW1 (antenna)						
V _{drop(SW1)}	dropout voltage	I _O = 300 mA	–	0.6	0.8	V
		I _O = 400 mA	–	0.6	1.1	V
I _{limit}	limit current	V ≥ 8.5 V	0.5	1	–	A

I²C-bus controlled 4 × 50 Watt power amplifier and multiple voltage regulator

TDA8588J; TDA8588xJ

SYMBOL	PARAMETER	CONDITIONS	MIN.	TYP.	MAX.	UNIT
Power switch 2: SW2 (amplifier)						
V _{drop(SW2)}	dropout voltage	I _O = 300 mA	–	0.6	0.8	V
		I _O = 400 mA	–	0.6	1.1	V
I _{limit}	limit current	V _O ≥ 8.5 V	0.5	1	–	A
Backup switch						
I _{DC(BU)}	continuous current	V _{BUCAP} ≥ 6 V	0.4	1.5	–	A
V _{clamp(BU)}	clamping voltage	V _P = 30 V; I _{O(REG2)} = 100 mA	–	24	28	V
V _{drop}	dropout voltage	I _O = 500 mA; (V _P – V _{BUCAP})	–	0.6	0.8	V

Notes

1. The quiescent current is measured in standby mode when R_L = ∞.
2. The rise and fall times are measured with a 50 pF load capacitor.
3. The reset delay time depends on the value of the reset delay capacitor:

$$t_{d(\text{rst})} = \frac{C_{\text{RESCAP}}}{I_{\text{ch}}} \times V_{\text{th}(\text{rst})} = C_{\text{RESCAP}} \times (750 \times 10^3) [\text{s}]$$

4. The dropout voltage of a regulator is the voltage difference between V_P and V_{O(REGn)}.
5. At current limit, V_{O(REGn)} is held constant (see Fig.6).
6. The foldback current protection limits the dissipation power at short-circuit (see Fig.6).
7. The dropout voltage of regulator 2 is the voltage difference between V_{BUCAP} and V_{O(REG2)}.

I²C-bus controlled 4 × 50 Watt power amplifier and multiple voltage regulator

TDA8588J; TDA8588xJ

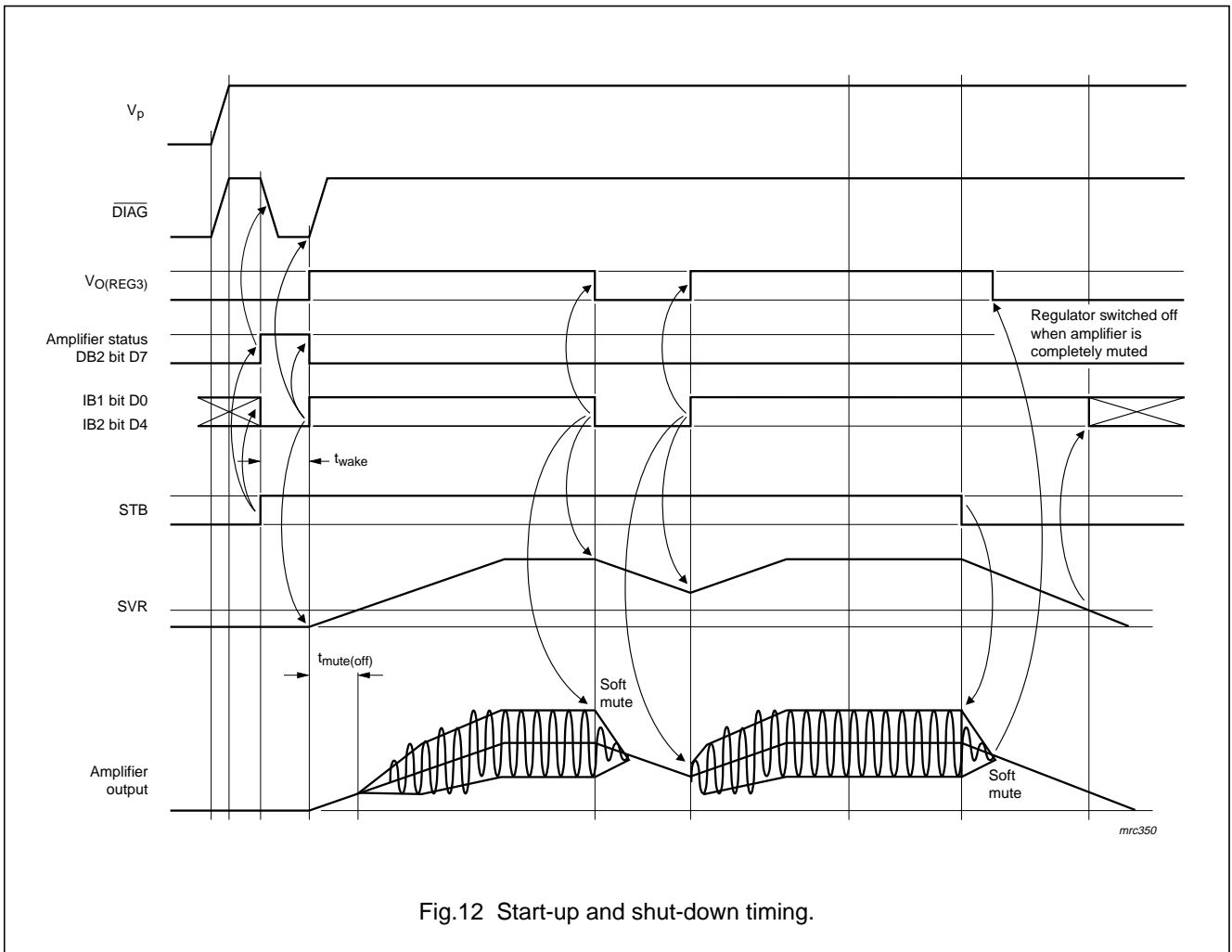

Fig.12 Start-up and shut-down timing.

I²C-bus controlled 4 × 50 Watt power amplifier and multiple voltage regulator

TDA8588J; TDA8588xJ

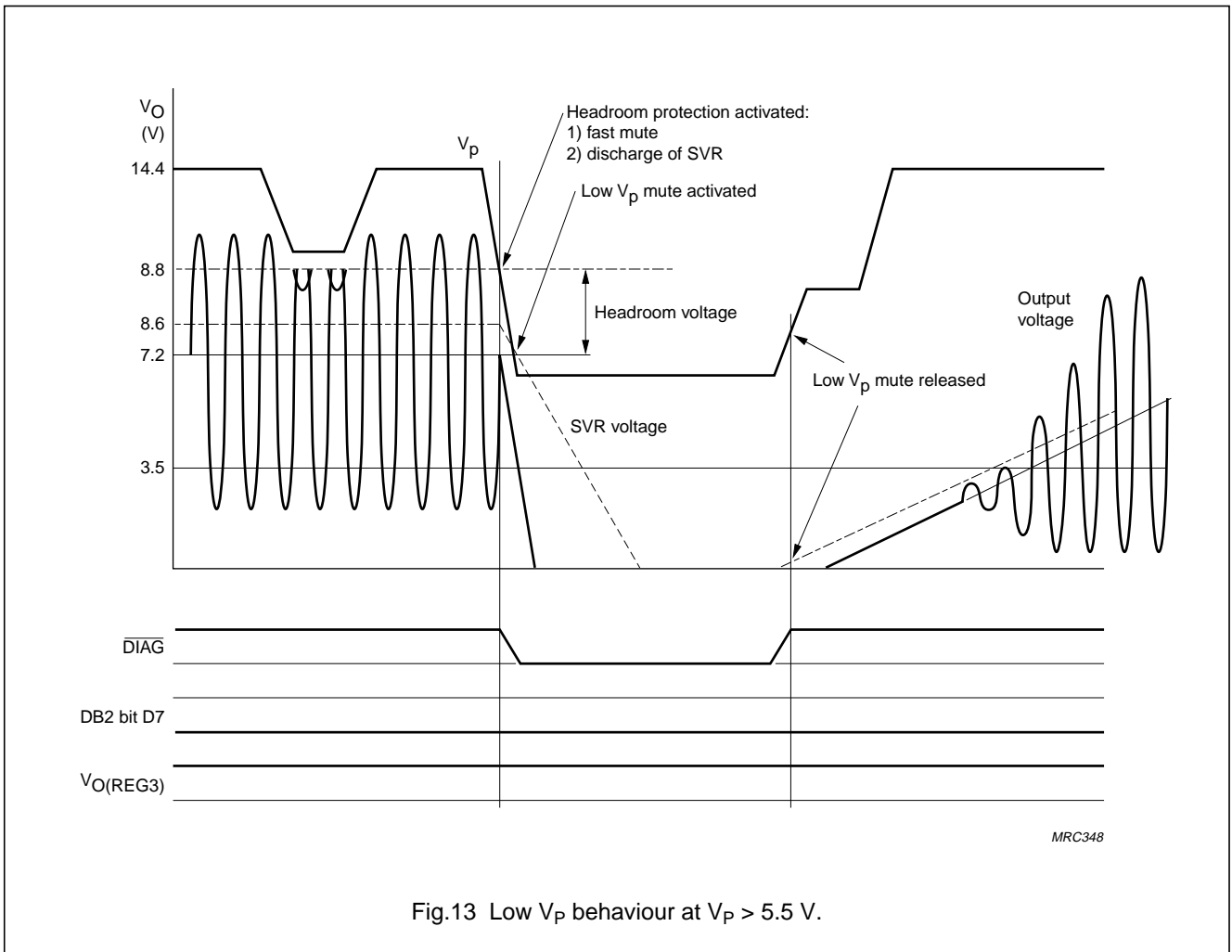

Fig.13 Low V_p behaviour at $V_p > 5.5$ V.

I²C-bus controlled 4 × 50 Watt power amplifier and multiple voltage regulator

TDA8588J; TDA8588xJ

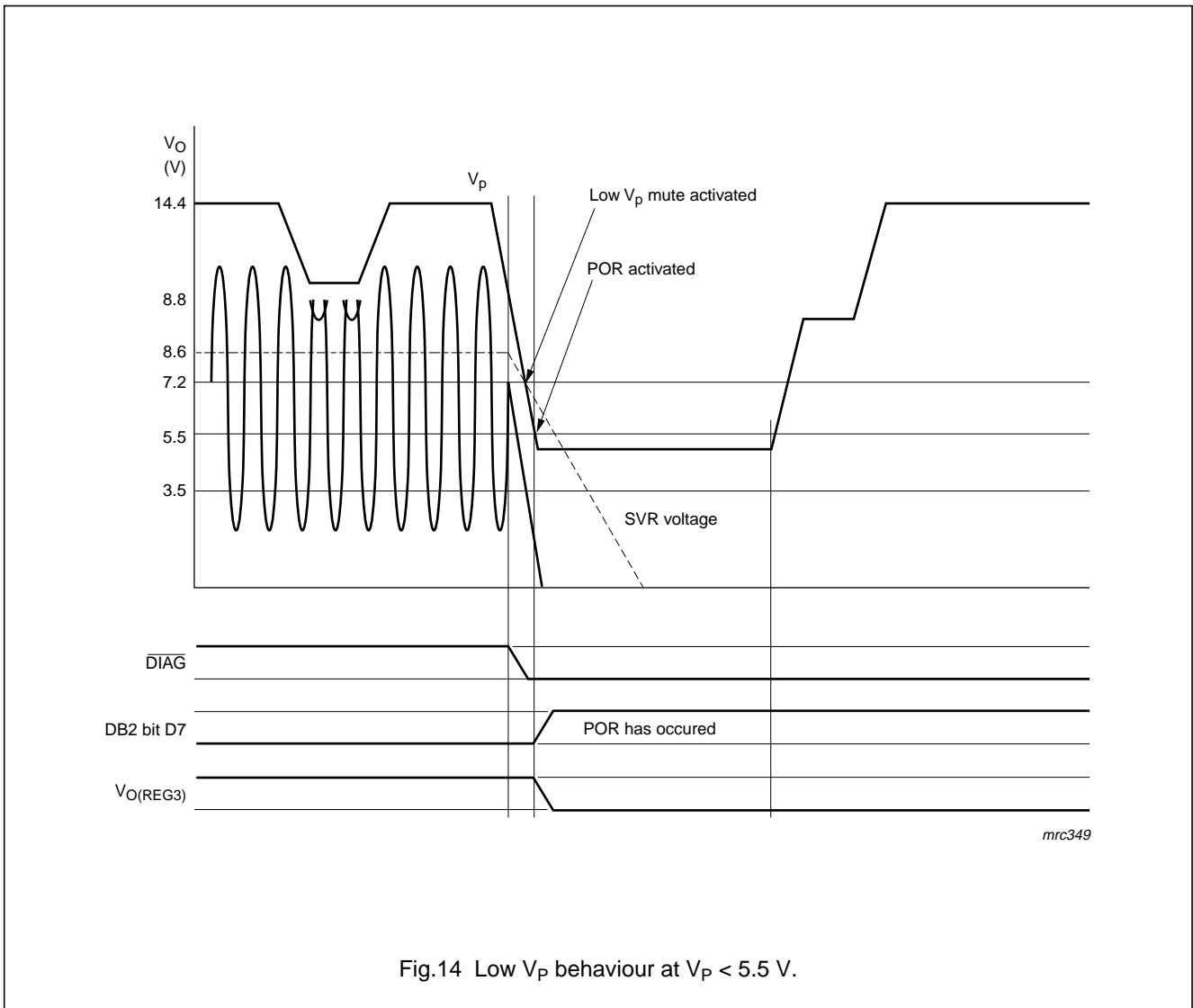

Fig.14 Low V_p behaviour at $V_p < 5.5$ V.

I²C-bus controlled 4 × 50 Watt power amplifier and multiple voltage regulator

TDA8588J; TDA8588xJ

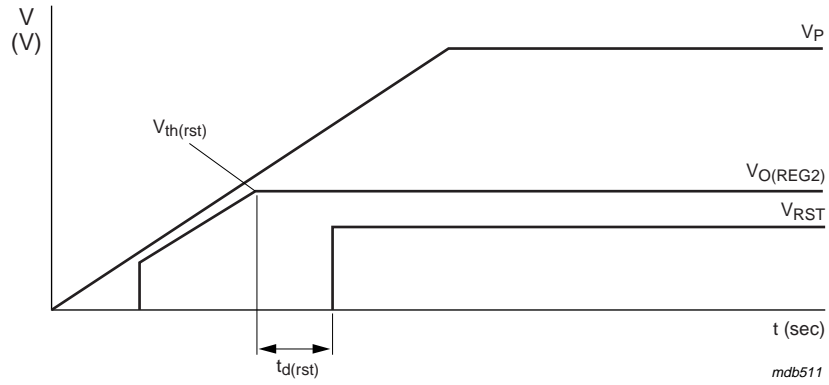

Fig.15 Reset delay function.

I²C-bus controlled 4 × 50 Watt power amplifier and multiple voltage regulator

TDA8588J; TDA8588xJ

Performance diagrams

THD AS A FUNCTION OF OUTPUT POWER P_O AT DIFFERENT FREQUENCIES

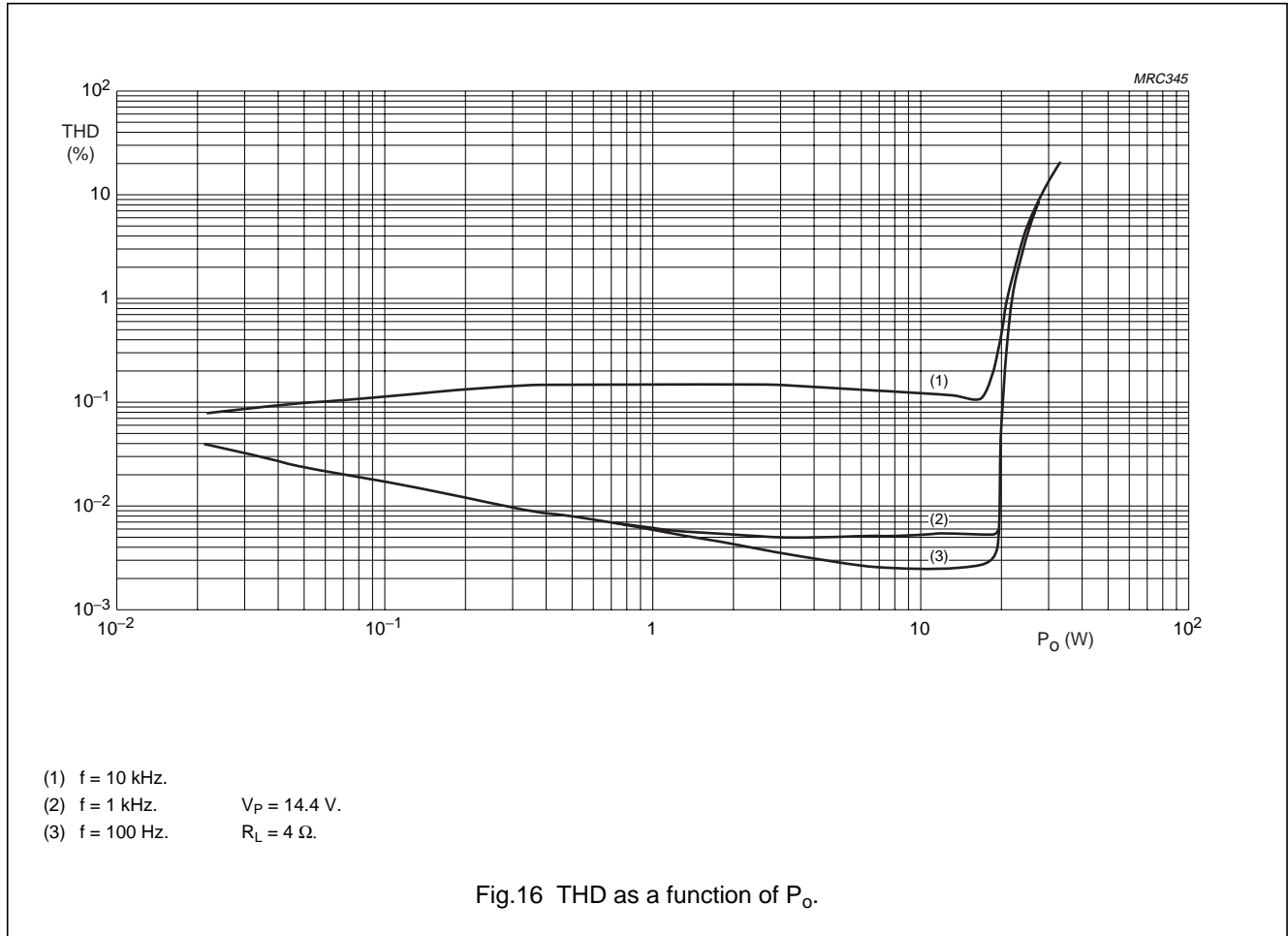

I²C-bus controlled 4 × 50 Watt power amplifier and multiple voltage regulator

TDA8588J; TDA8588xJ

THD AS A FUNCTION OF FREQUENCY AT DIFFERENT OUTPUT POWERS

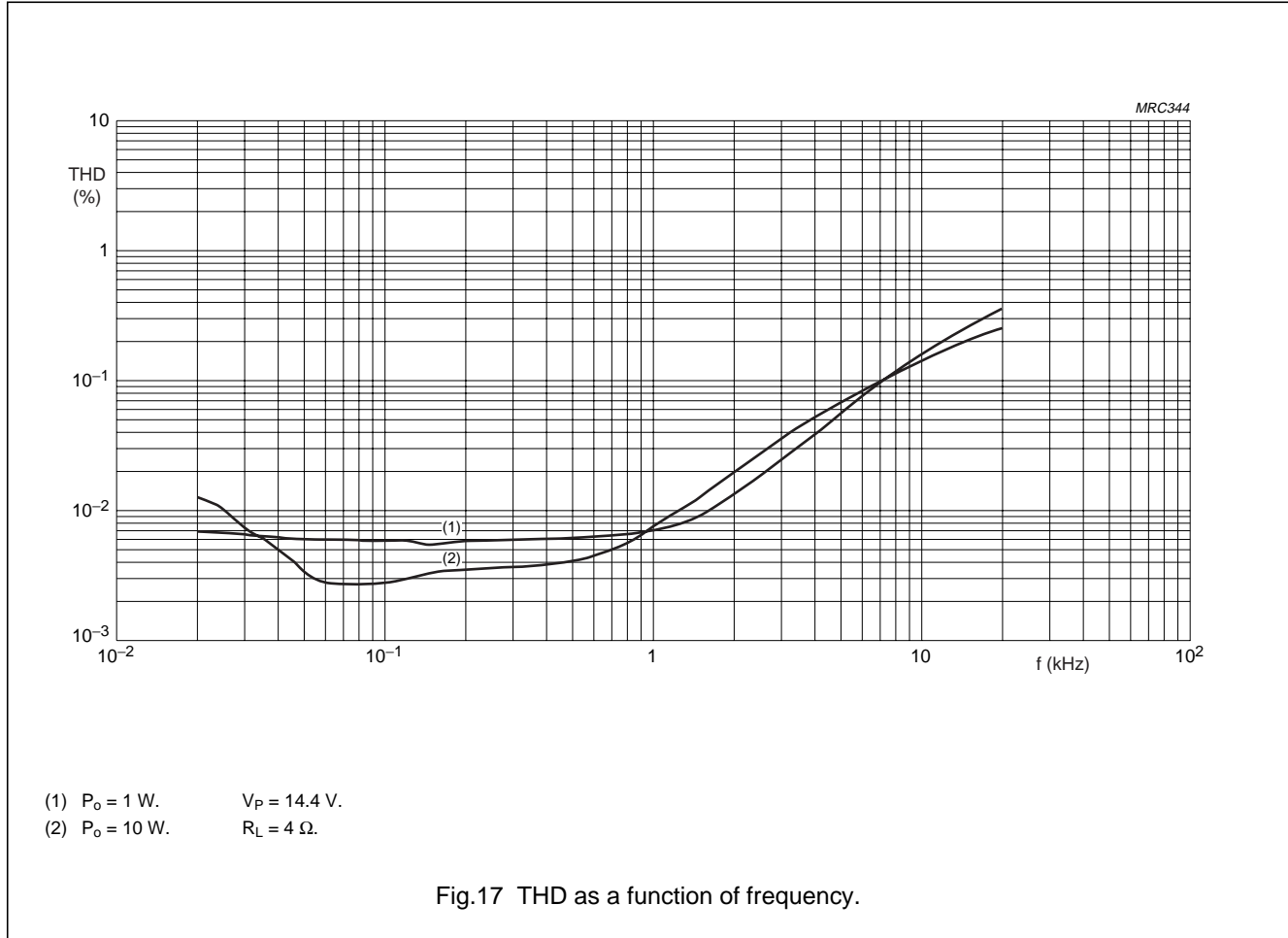

I²C-bus controlled 4 × 50 Watt power amplifier and multiple voltage regulator

TDA8588J; TDA8588xJ

LINE DRIVER MODE

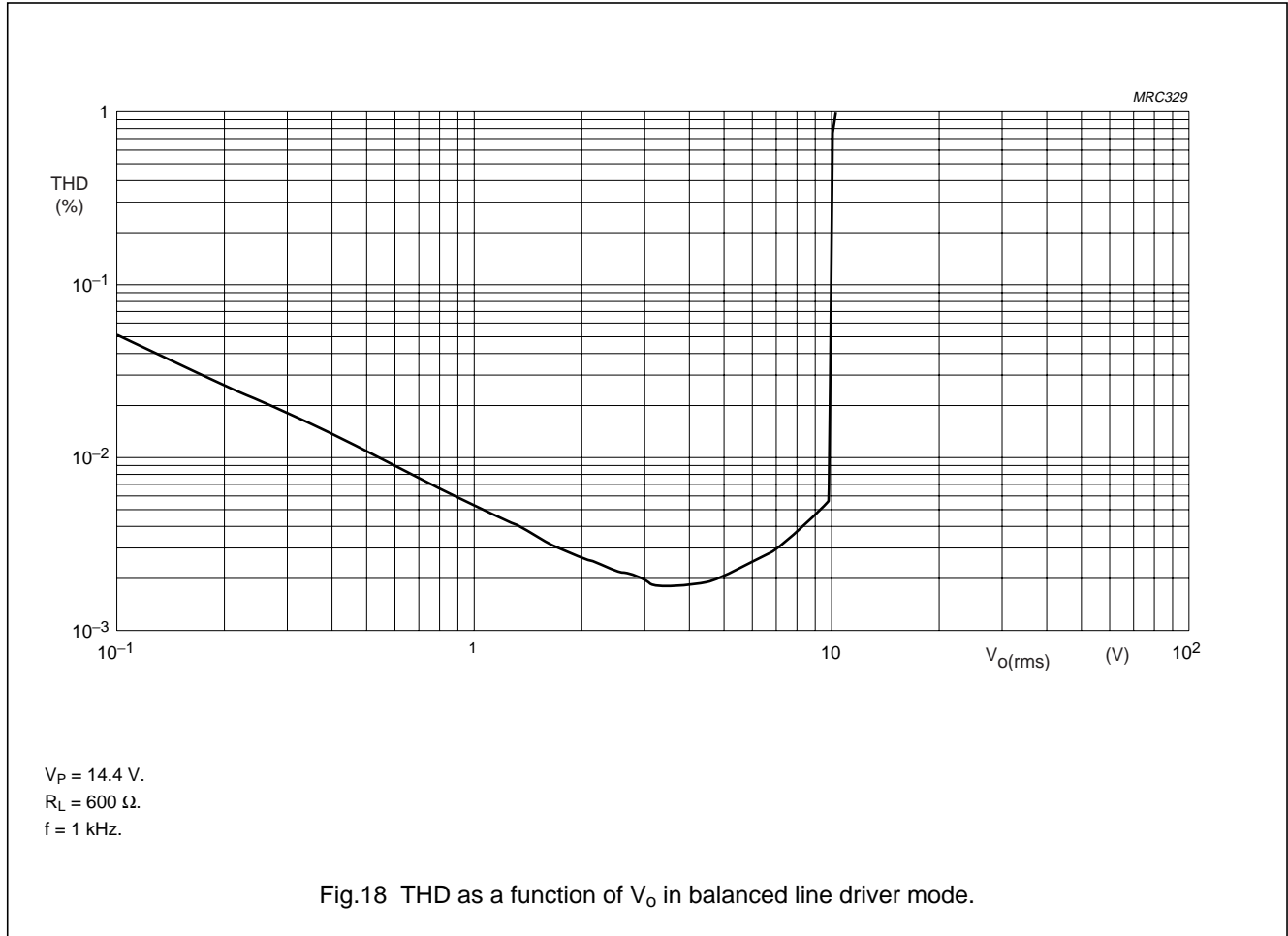

I²C-bus controlled 4 × 50 Watt power amplifier and multiple voltage regulator

TDA8588J; TDA8588xJ

OUTPUT POWER AS A FUNCTION OF FREQUENCY AT DIFFERENT THD LEVELS

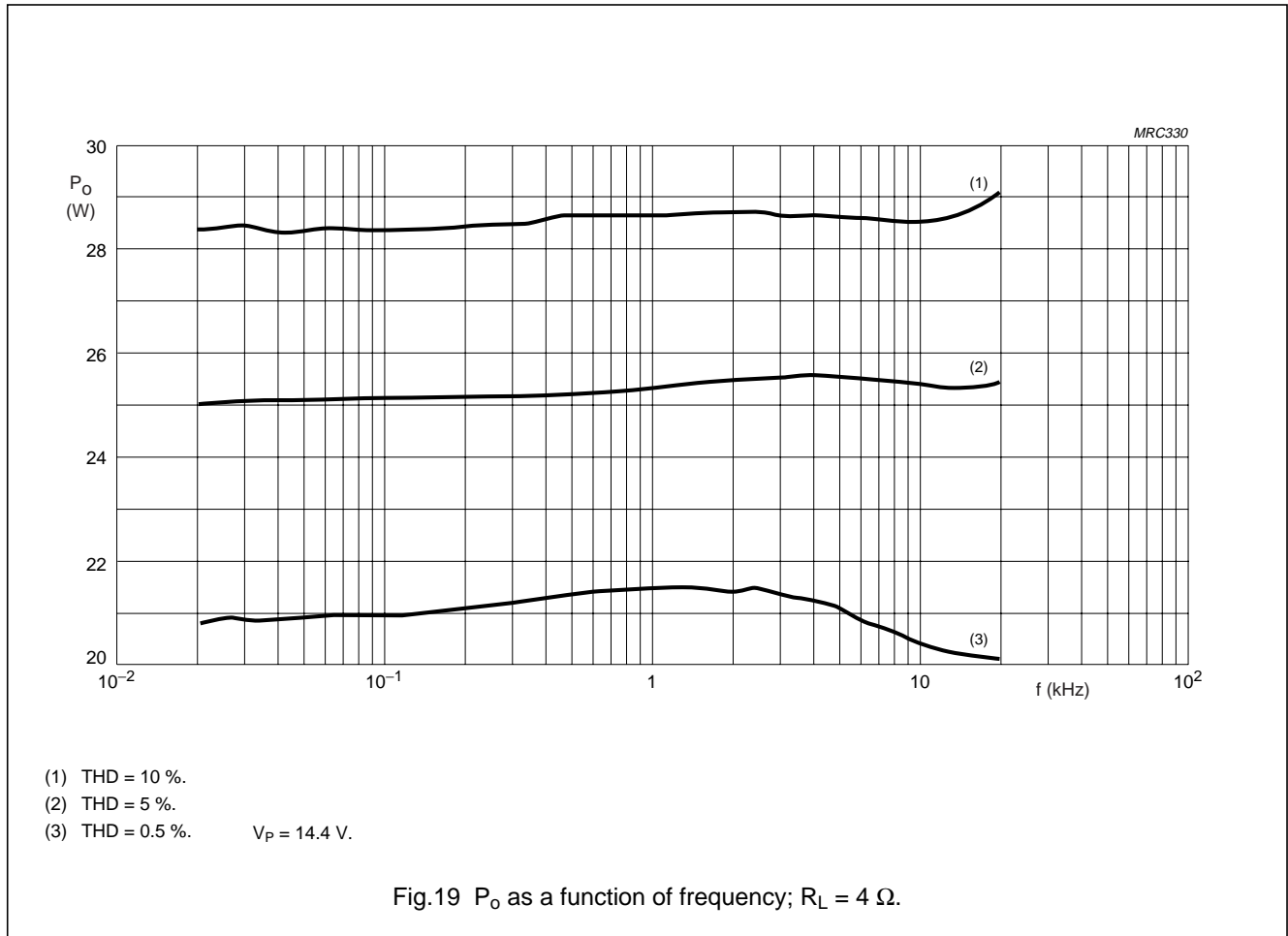

I²C-bus controlled 4 × 50 Watt power amplifier and multiple voltage regulator

TDA8588J; TDA8588xJ

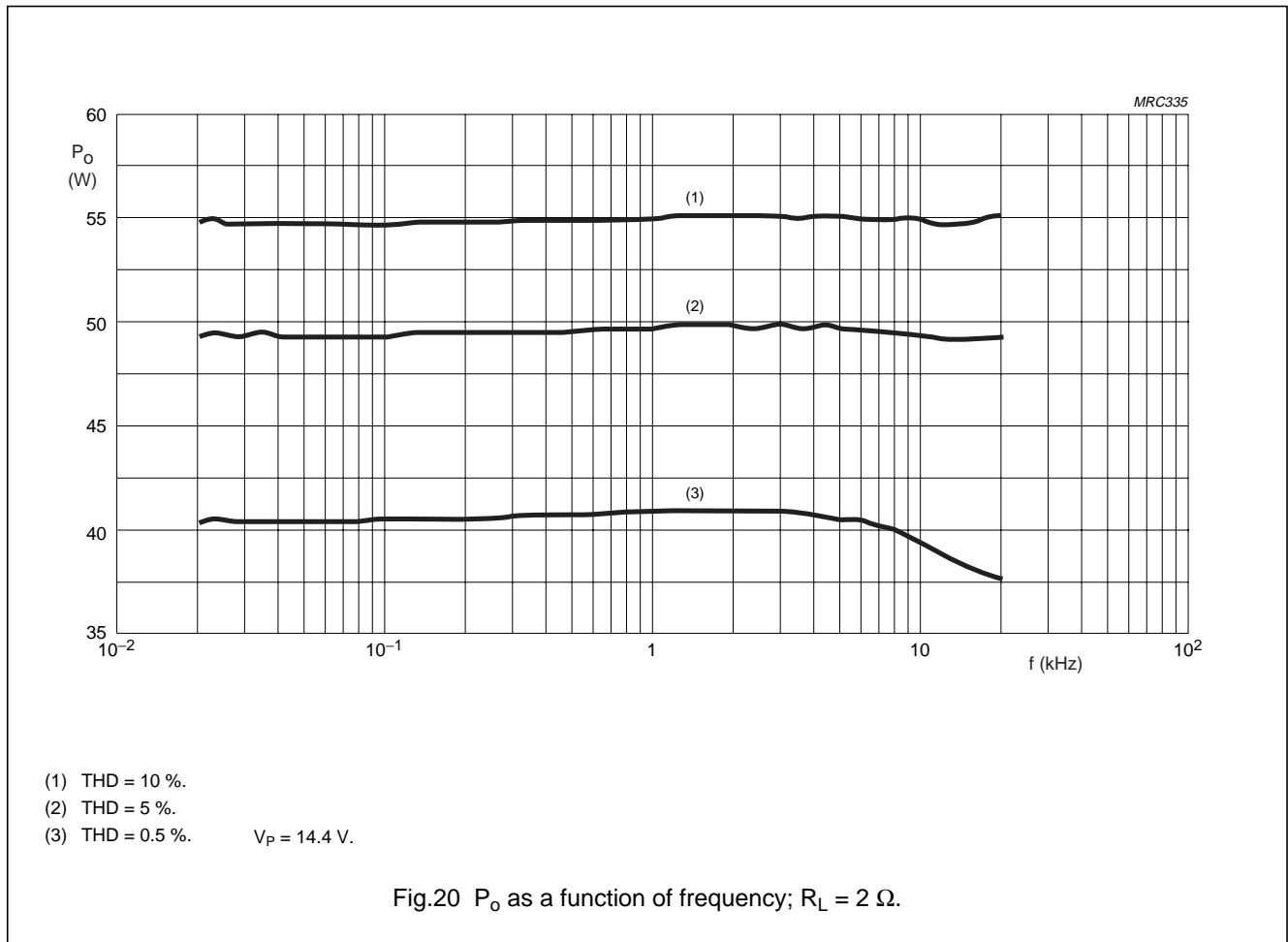

I²C-bus controlled 4 × 50 Watt power amplifier and multiple voltage regulator

TDA8588J; TDA8588xJ

OUTPUT POWER (P_O) AS A FUNCTION OF SUPPLY VOLTAGE (V_P)

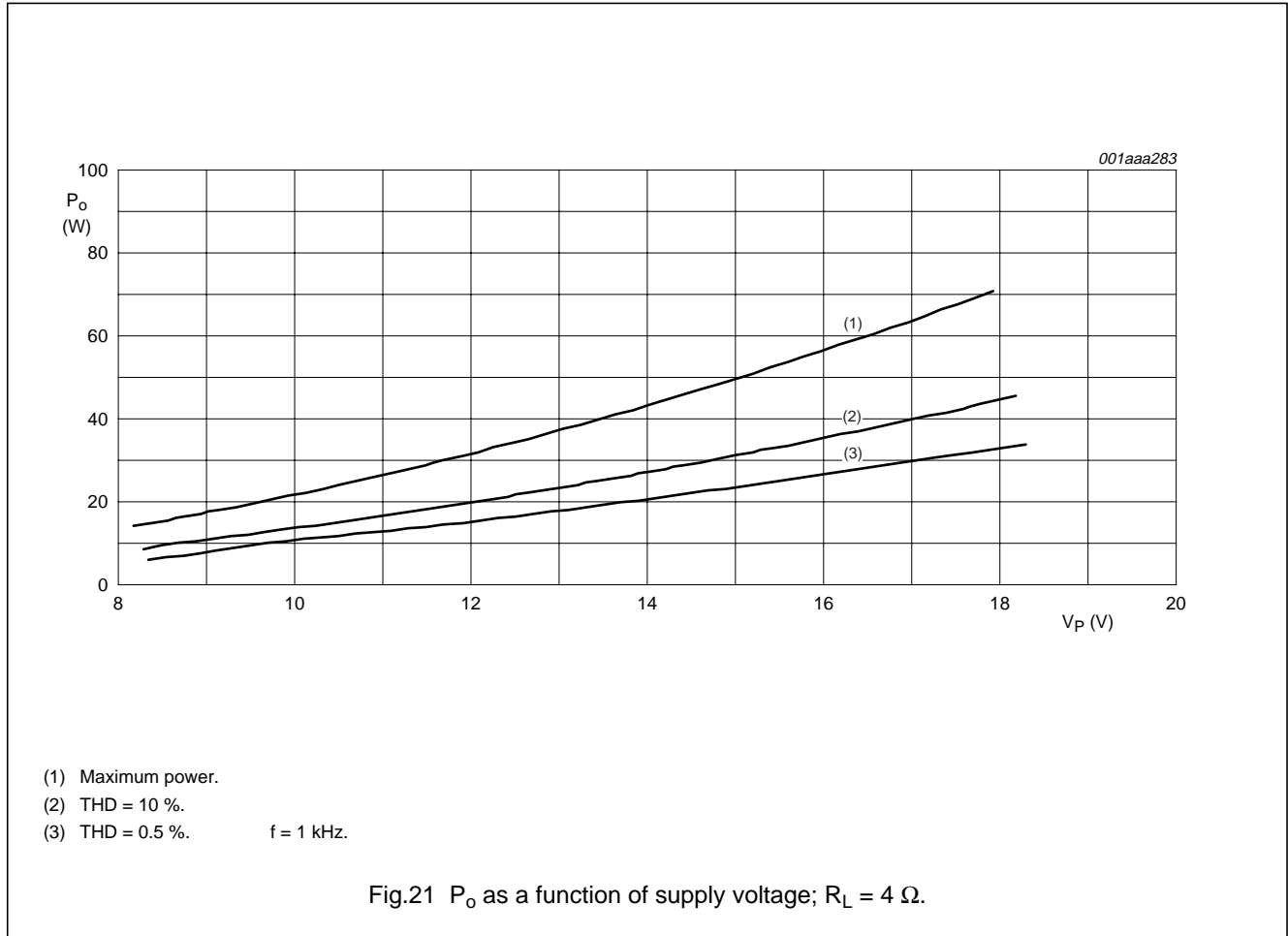

I²C-bus controlled 4 × 50 Watt power amplifier and multiple voltage regulator

TDA8588J; TDA8588xJ

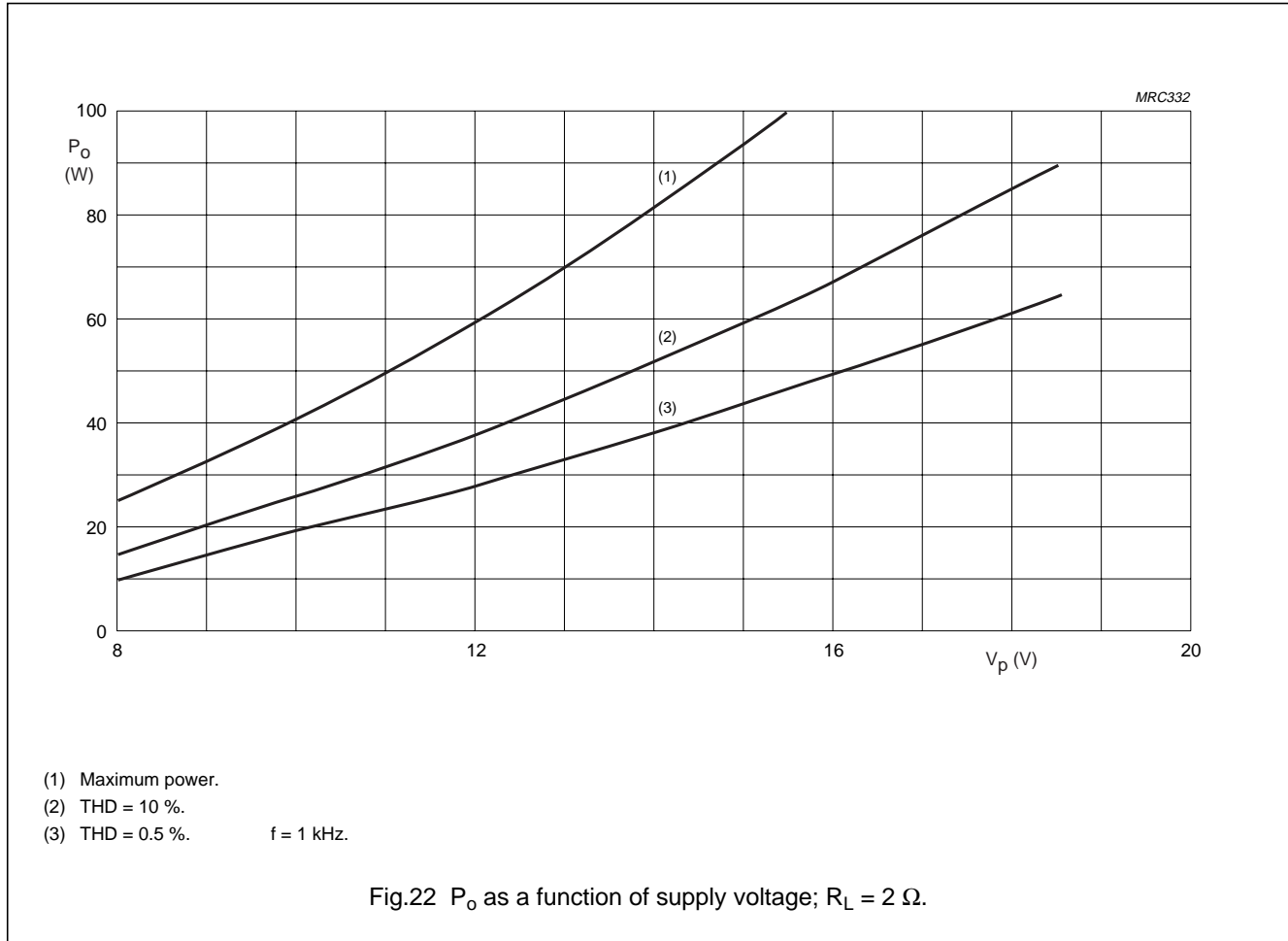

I²C-bus controlled 4 × 50 Watt power amplifier and multiple voltage regulator

TDA8588J; TDA8588xJ

SUPPLY VOLTAGE RIPPLE REJECTION IN OPERATING AND MUTE MODES

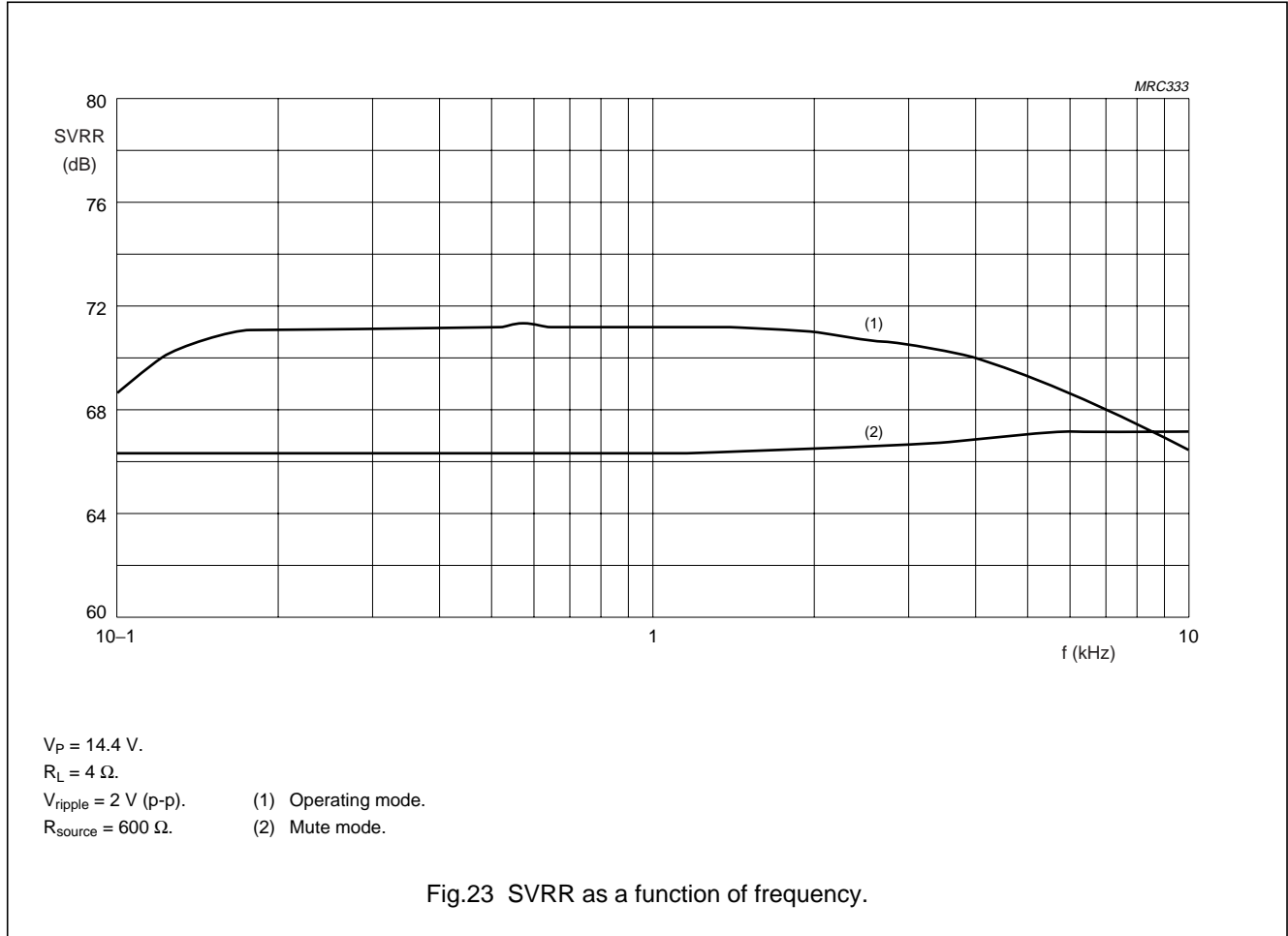

I²C-bus controlled 4 × 50 Watt power amplifier and multiple voltage regulator

TDA8588J; TDA8588xJ

CHANNEL SEPARATION AS A FUNCTION OF FREQUENCY

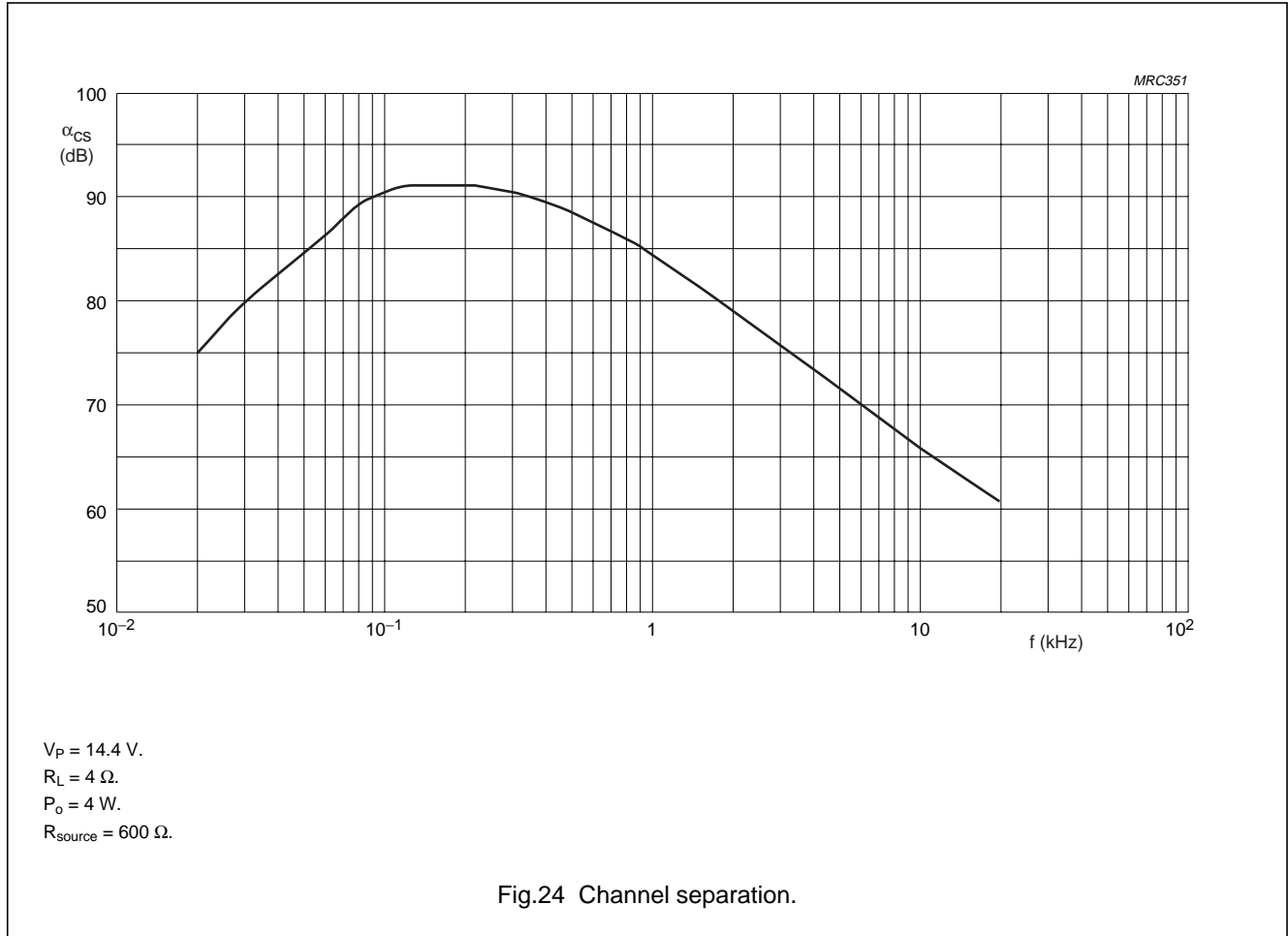

I²C-bus controlled 4 × 50 Watt power amplifier and multiple voltage regulator

TDA8588J; TDA8588xJ

POWER DISSIPATION AND EFFICIENCY

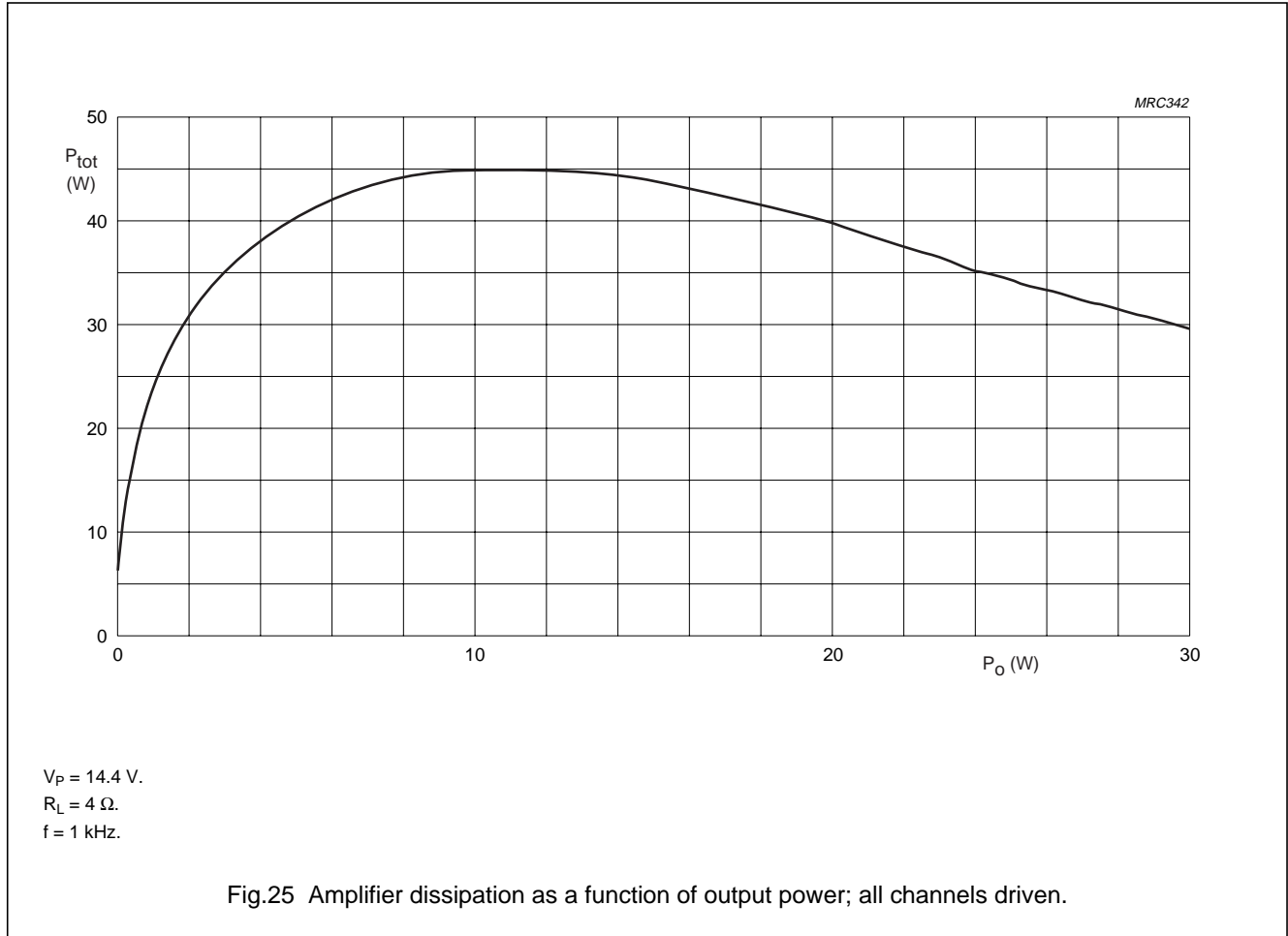

I²C-bus controlled 4 × 50 Watt power amplifier and multiple voltage regulator

TDA8588J; TDA8588xJ

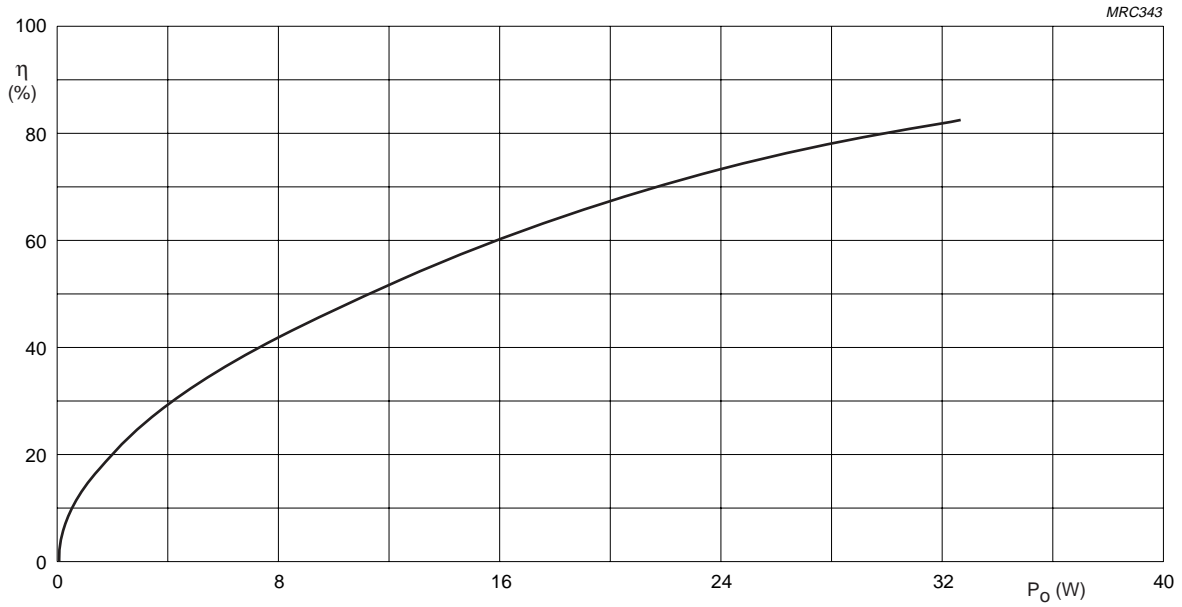

$V_p = 14.4$ V.
 $R_L = 4$ Ω .
 $f = 1$ kHz.

Fig.26 Amplifier efficiency as a function of output power; all channels driven.

I²C-bus controlled 4 × 50 Watt power amplifier and multiple voltage regulator

TDA8588J; TDA8588xJ

APPLICATION AND TEST INFORMATION

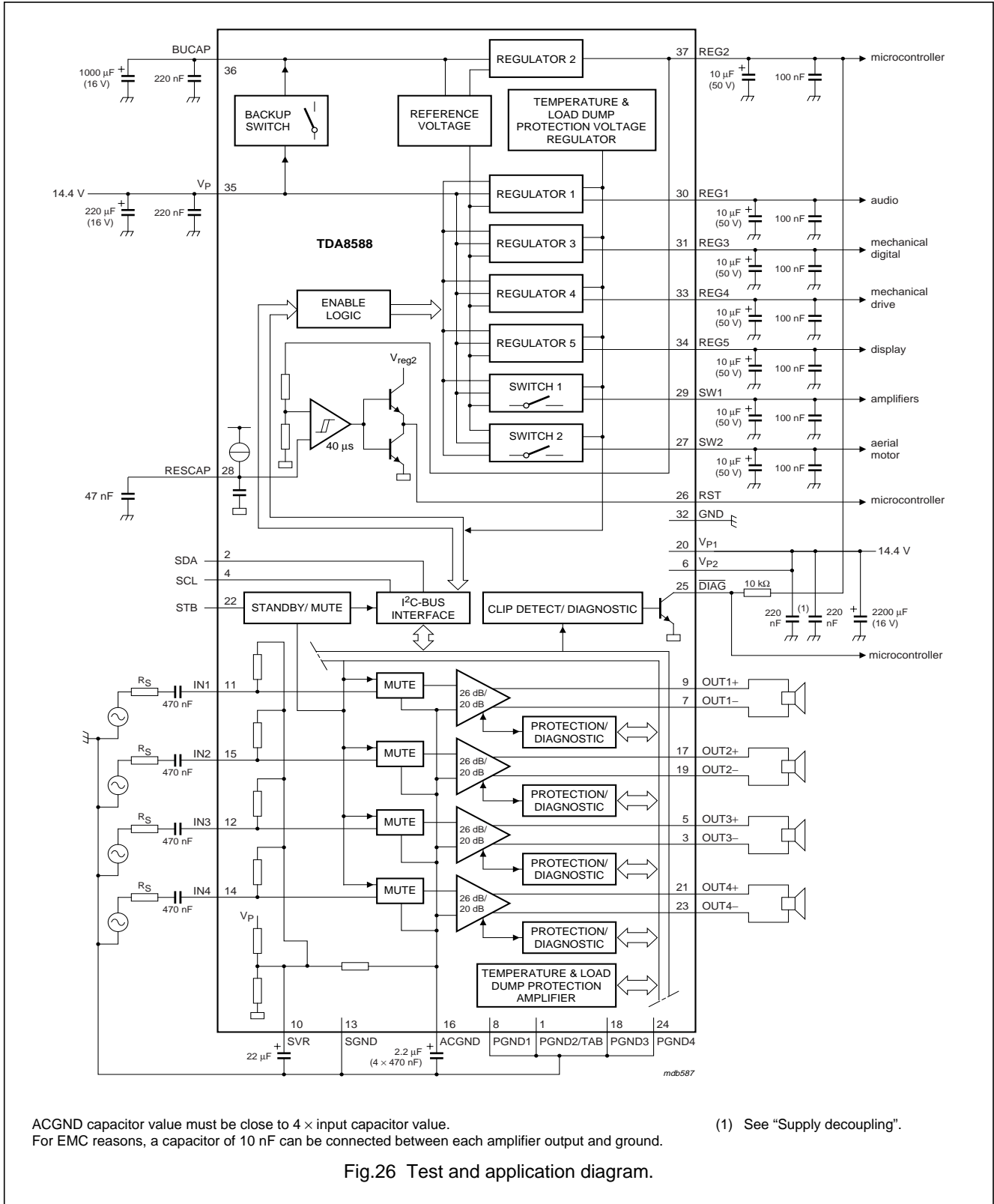

**I²C-bus controlled 4 × 50 Watt power
amplifier and multiple voltage regulator**

TDA8588J; TDA8588xJ**Supply decoupling**

(see Fig.26)

The high frequency 220 nF decoupling capacitors connected to power supply voltage pins 6 and 20 should be located as close as possible to these pins.

It is important to use good quality capacitors. These capacitors should be able to suppress high voltage peaks that can occur on the power supply if several audio channels are accidentally shorted to the power supply simultaneously, due to the activation of current protection. Good results have been achieved using 0805 case-size capacitors (X7R material, 220 nF) located close to power supply voltage pins 6 and 20.

I²C-bus controlled 4 × 50 Watt power amplifier and multiple voltage regulator

TDA8588J; TDA8588xJ

PCB layout

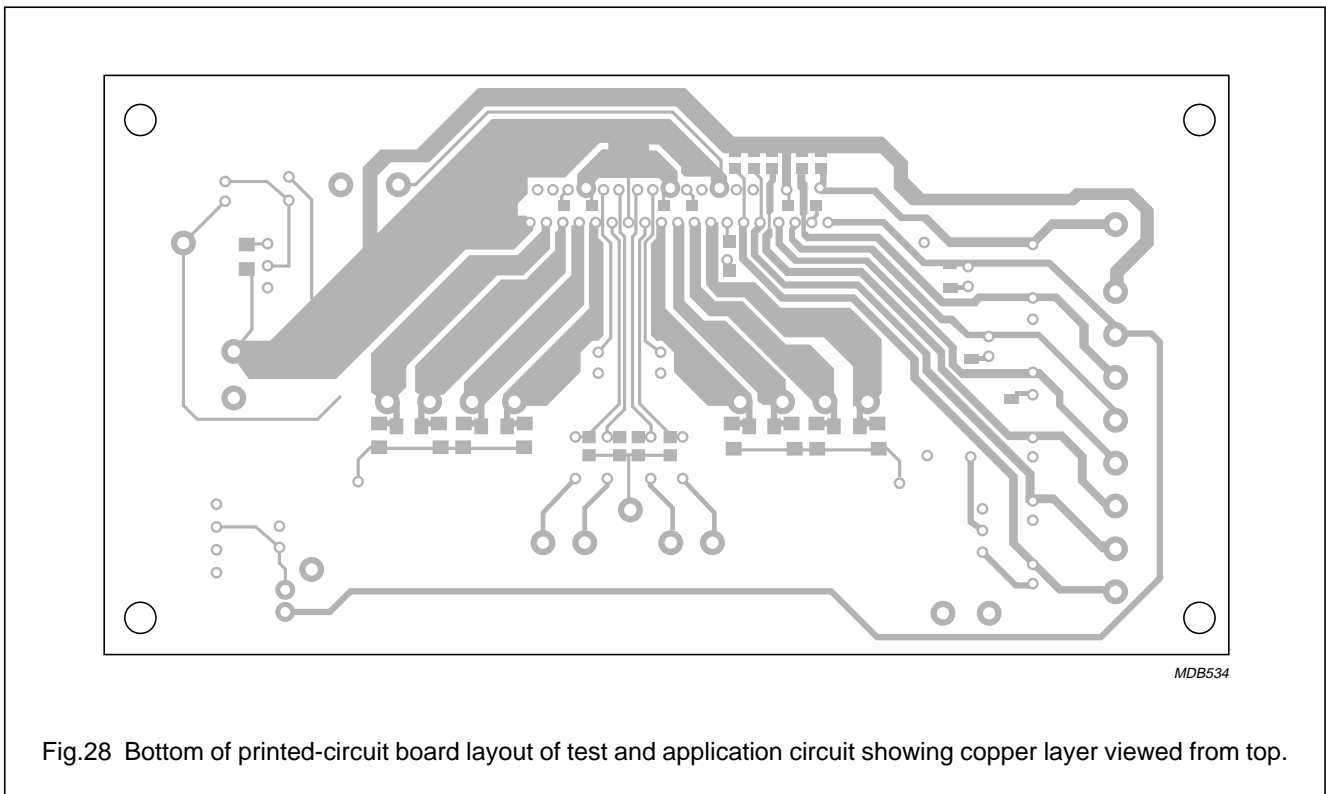
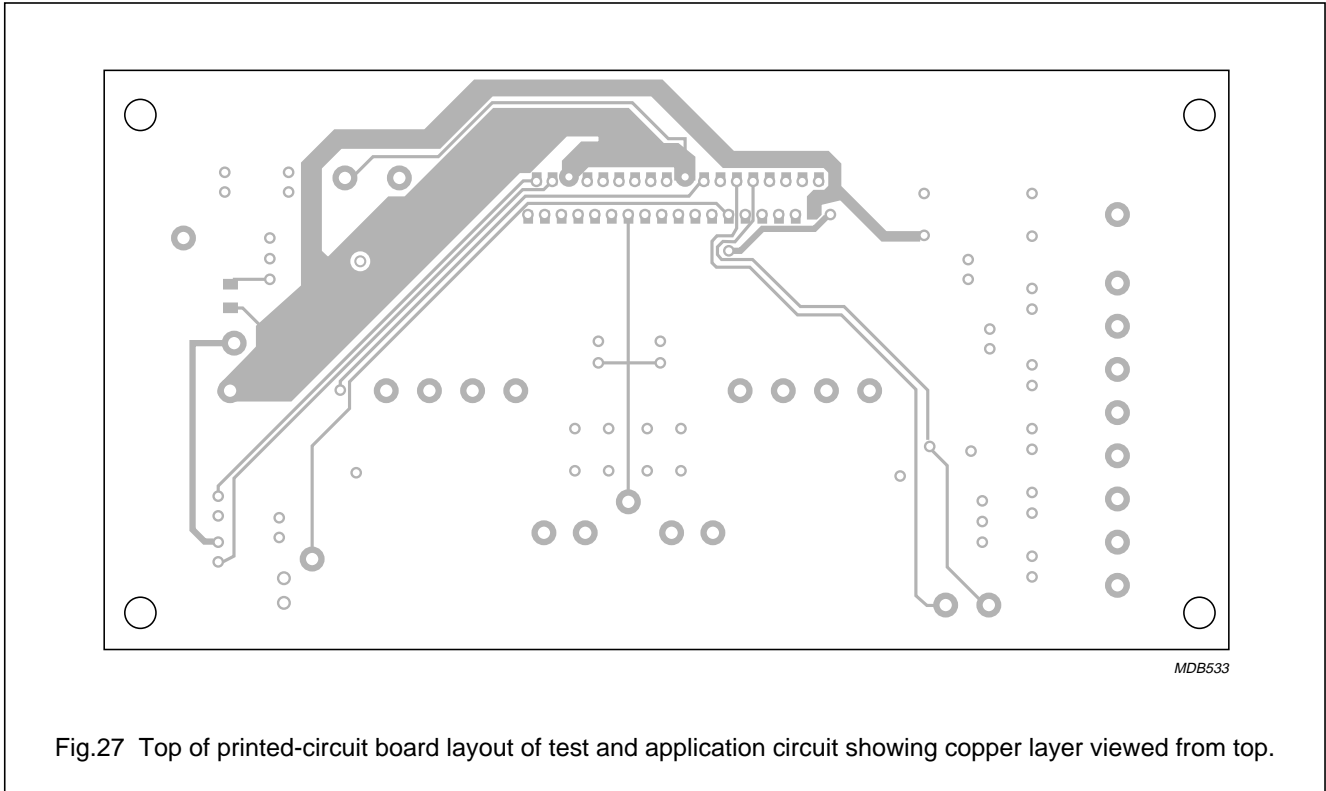

I²C-bus controlled 4 × 50 Watt power amplifier and multiple voltage regulator

TDA8588J; TDA8588xJ

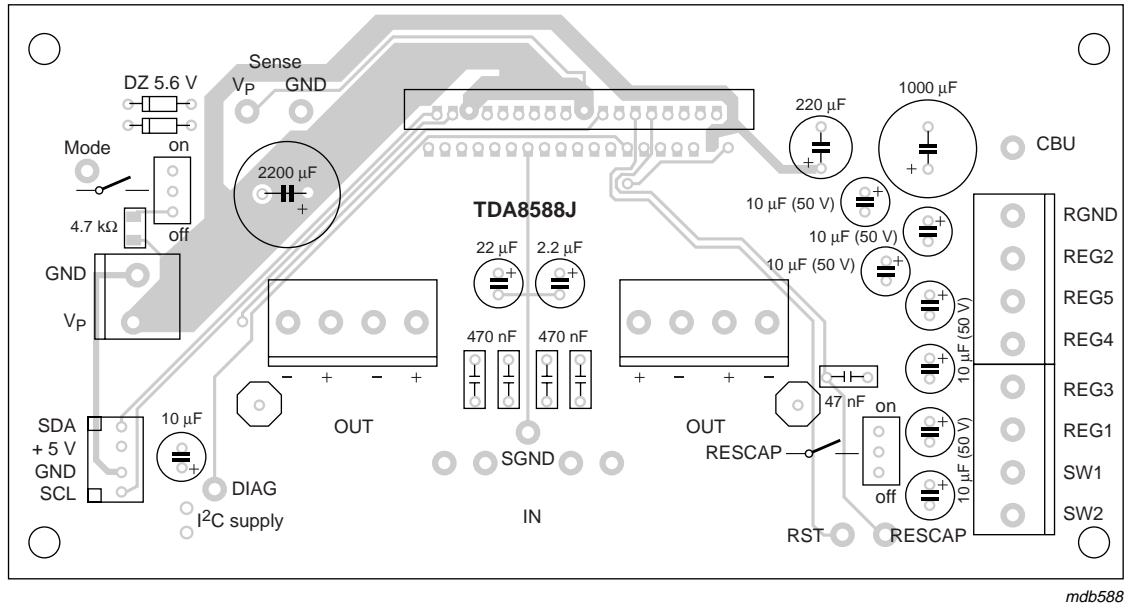

Fig.29 Top of printed-circuit board layout of test and application circuit showing components viewed from top.

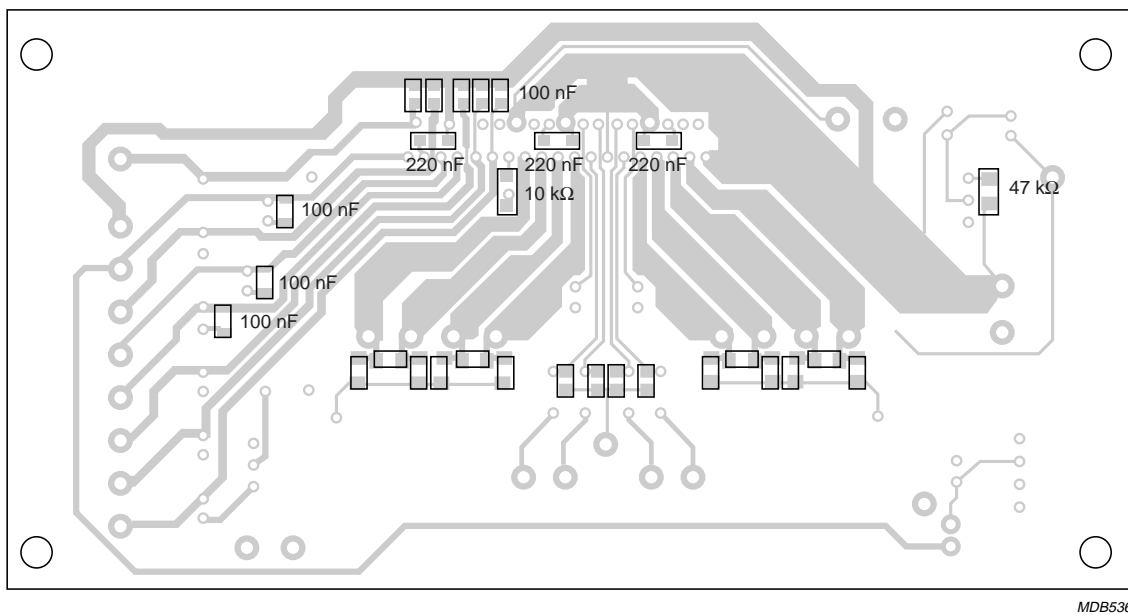

Fig.30 Bottom of printed-circuit board layout of test and application circuit showing components viewed from bottom.

I²C-bus controlled 4 × 50 Watt power amplifier and multiple voltage regulator

TDA8588J; TDA8588xJ

Beep input circuit

Beep input circuit to amplify the beep signal from the microcontroller to all 4 amplifiers (gain = 0 dB). Note that this circuit will not affect amplifier performance.

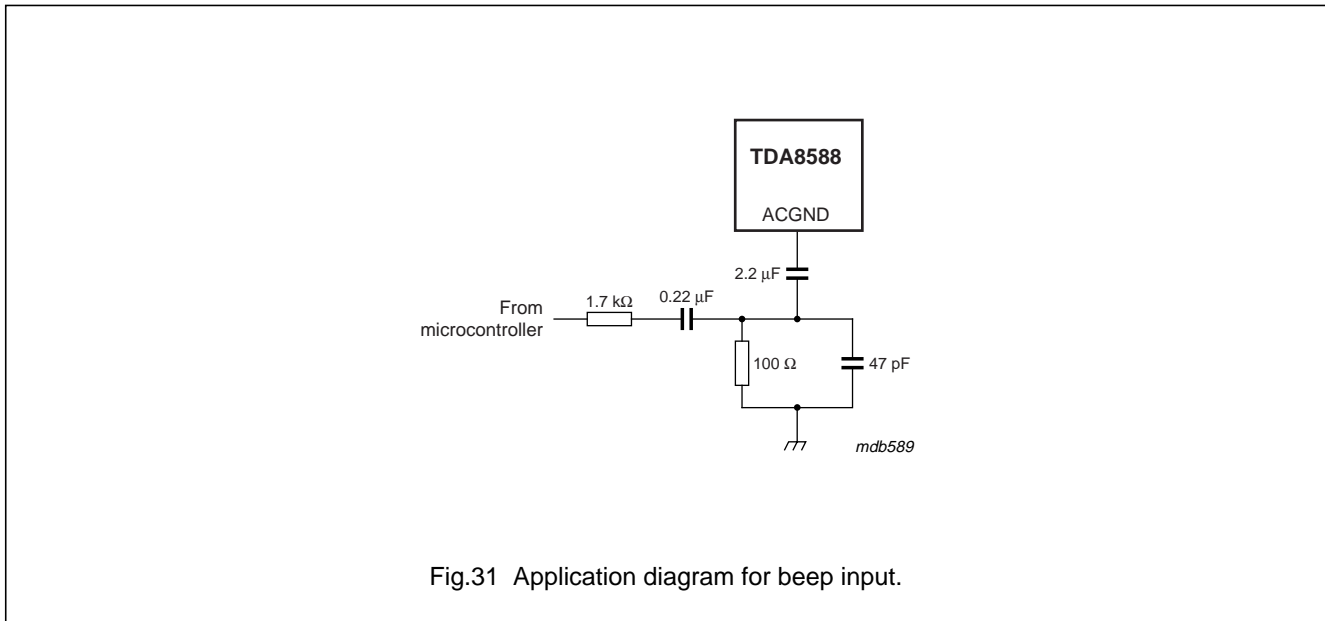

Noise

The outputs of regulators 1 to 5 are designed to give very low noise with good stability. The noise output voltage depends on output capacitor C_o. Table 11 shows the affect of the output capacitor on the noise figure.

Table 11 Regulator noise figures

REGULATOR	NOISE FIGURE (μV) at I _{REG} = 10 mA; note 1		
	C _o = 10 μF	C _o = 47 μF	C _o = 100 μF
1	225	195	185
2	750	550	530
3	120	100	95
4	225	195	185
5	320	285	270

Note

1. Measured in the frequency range 20 Hz to 80 kHz.

Stability

The regulators are made stable by connecting capacitors to the regulator outputs. The stability can be guaranteed with almost any output capacitor if its Electric Series Resistance (ESR) stays below the ESR curve shown in Fig.32. If an electrolytic capacitor is used, its behaviour with temperature can cause oscillations at extremely low temperature. Oscillation problems can be avoided by adding a 47 nF capacitor in parallel with the electrolytic capacitor. The following example describes how to select the value of output capacitor.

I²C-bus controlled 4 × 50 Watt power amplifier and multiple voltage regulator

TDA8588J; TDA8588xJ

EXAMPLE REGULATOR 2

Regulator 2 is stabilized with an electrolytic output capacitor of 10 μF which has an ESR of 4 Ω . At $T_{\text{amb}} = -30\text{ }^{\circ}\text{C}$ the capacitor value decreases to 3 μF and its ESR increases to 28 Ω which is above the maximum allowed as shown in Fig.32, and which will make the regulator unstable. To avoid problems with stability at low temperatures, the recommended solution is to use tantalum capacitors. Either use a tantalum capacitor of 10 μF , or an electrolytic capacitor with a higher value.

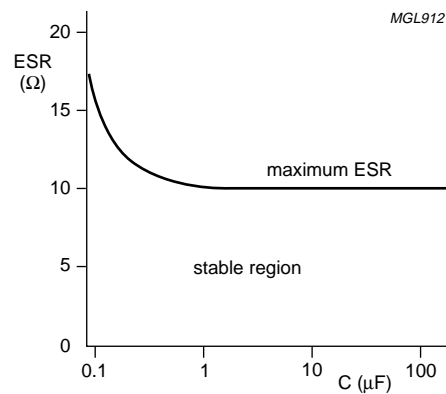

Fig.32 Curve for selecting the value of output capacitors for regulators 1 to 5.

I²C-bus controlled 4 × 50 Watt power amplifier and multiple voltage regulator

TDA8588J; TDA8588xJ

PACKAGE OUTLINE

DBS37P: plastic DIL-bent-SIL power package; 37 leads (lead length 6.8 mm)

SOT725-1

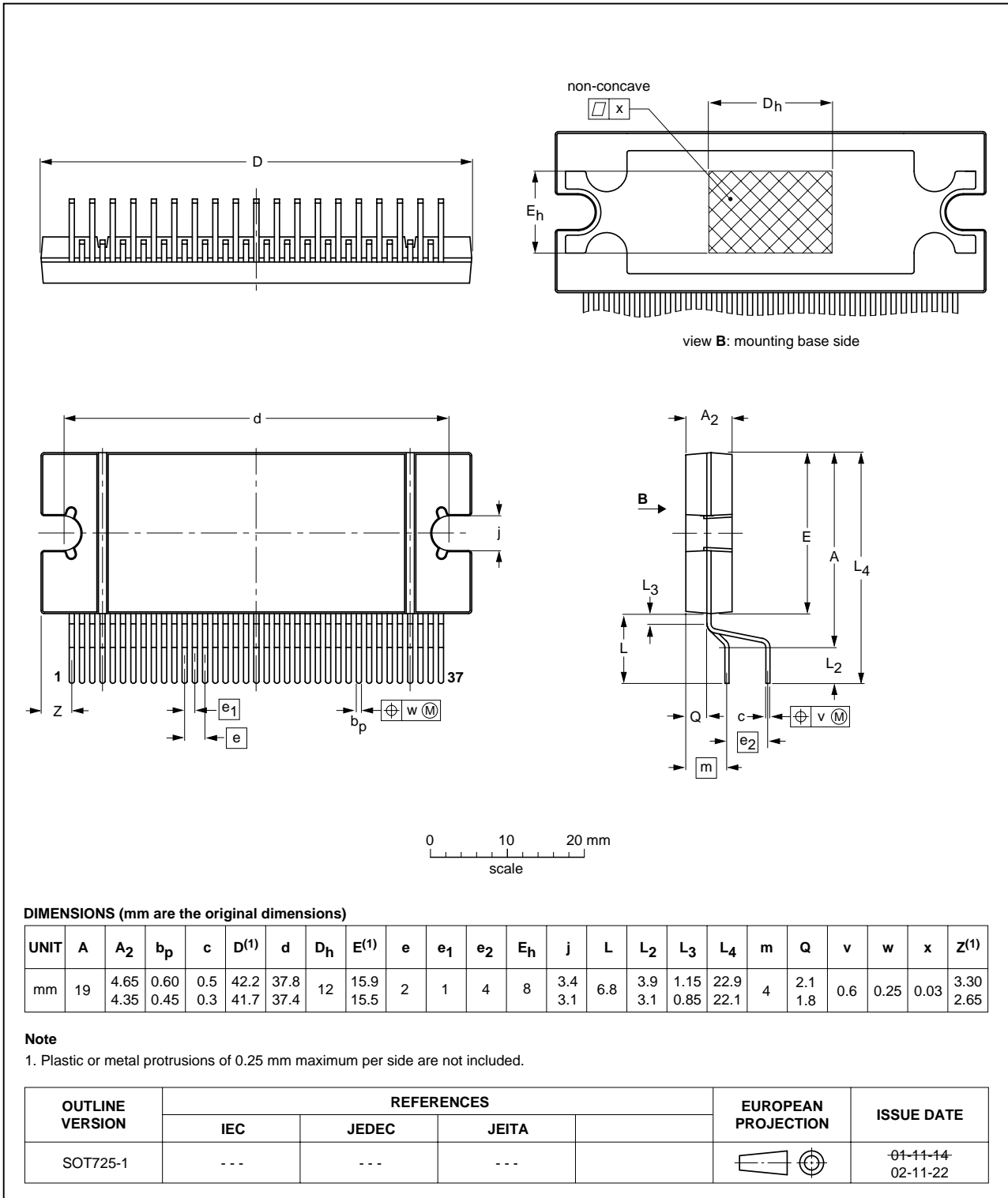

I²C-bus controlled 4 × 50 Watt power amplifier and multiple voltage regulator

TDA8588J; TDA8588xJ

SOLDERING

Introduction to soldering through-hole mount packages

This text gives a brief insight to wave, dip and manual soldering. A more in-depth account of soldering ICs can be found in our *"Data Handbook IC26; Integrated Circuit Packages"* (document order number 9398 652 90011).

Wave soldering is the preferred method for mounting of through-hole mount IC packages on a printed-circuit board.

Soldering by dipping or by solder wave

Driven by legislation and environmental forces the worldwide use of lead-free solder pastes is increasing. Typical dwell time of the leads in the wave ranges from 3 to 4 seconds at 250 °C or 265 °C, depending on solder material applied, SnPb or Pb-free respectively.

The total contact time of successive solder waves must not exceed 5 seconds.

The device may be mounted up to the seating plane, but the temperature of the plastic body must not exceed the specified maximum storage temperature ($T_{stg(max)}$). If the printed-circuit board has been pre-heated, forced cooling may be necessary immediately after soldering to keep the temperature within the permissible limit.

Manual soldering

Apply the soldering iron (24 V or less) to the lead(s) of the package, either below the seating plane or not more than 2 mm above it. If the temperature of the soldering iron bit is less than 300 °C it may remain in contact for up to 10 seconds. If the bit temperature is between 300 and 400 °C, contact may be up to 5 seconds.

Suitability of through-hole mount IC packages for dipping and wave soldering methods

PACKAGE	SOLDERING METHOD	
	DIPPING	WAVE
DBS, DIP, HDIP, RDBS, SDIP, SIL	suitable	suitable ⁽¹⁾
PMFP ⁽²⁾	–	not suitable

Notes

- For SDIP packages, the longitudinal axis must be parallel to the transport direction of the printed-circuit board.
- For PMFP packages hot bar soldering or manual soldering is suitable.

I²C-bus controlled 4 × 50 Watt power amplifier and multiple voltage regulator

TDA8588J; TDA8588xJ

DATA SHEET STATUS

LEVEL	DATA SHEET STATUS ⁽¹⁾	PRODUCT STATUS ⁽²⁾⁽³⁾	DEFINITION
I	Objective data	Development	This data sheet contains data from the objective specification for product development. Philips Semiconductors reserves the right to change the specification in any manner without notice.
II	Preliminary data	Qualification	This data sheet contains data from the preliminary specification. Supplementary data will be published at a later date. Philips Semiconductors reserves the right to change the specification without notice, in order to improve the design and supply the best possible product.
III	Product data	Production	This data sheet contains data from the product specification. Philips Semiconductors reserves the right to make changes at any time in order to improve the design, manufacturing and supply. Relevant changes will be communicated via a Customer Product/Process Change Notification (CPCN).

Notes

1. Please consult the most recently issued data sheet before initiating or completing a design.
2. The product status of the device(s) described in this data sheet may have changed since this data sheet was published. The latest information is available on the Internet at URL <http://www.semiconductors.philips.com>.
3. For data sheets describing multiple type numbers, the highest-level product status determines the data sheet status.

DEFINITIONS

Short-form specification — The data in a short-form specification is extracted from a full data sheet with the same type number and title. For detailed information see the relevant data sheet or data handbook.

Limiting values definition — Limiting values given are in accordance with the Absolute Maximum Rating System (IEC 60134). Stress above one or more of the limiting values may cause permanent damage to the device. These are stress ratings only and operation of the device at these or at any other conditions above those given in the Characteristics sections of the specification is not implied. Exposure to limiting values for extended periods may affect device reliability.

Application information — Applications that are described herein for any of these products are for illustrative purposes only. Philips Semiconductors make no representation or warranty that such applications will be suitable for the specified use without further testing or modification.

DISCLAIMERS

Life support applications — These products are not designed for use in life support appliances, devices, or systems where malfunction of these products can reasonably be expected to result in personal injury. Philips Semiconductors customers using or selling these products for use in such applications do so at their own risk and agree to fully indemnify Philips Semiconductors for any damages resulting from such application.

Right to make changes — Philips Semiconductors reserves the right to make changes in the products - including circuits, standard cells, and/or software - described or contained herein in order to improve design and/or performance. When the product is in full production (status 'Production'), relevant changes will be communicated via a Customer Product/Process Change Notification (CPCN). Philips Semiconductors assumes no responsibility or liability for the use of any of these products, conveys no licence or title under any patent, copyright, or mask work right to these products, and makes no representations or warranties that these products are free from patent, copyright, or mask work right infringement, unless otherwise specified.

I²C-bus controlled 4 × 50 Watt power
amplifier and multiple voltage regulator

TDA8588J; TDA8588xJ

PURCHASE OF PHILIPS I²C COMPONENTS



Purchase of Philips I²C components conveys a license under the Philips' I²C patent to use the components in the I²C system provided the system conforms to the I²C specification defined by Philips. This specification can be ordered using the code 9398 393 40011.

Philips Semiconductors – a worldwide company

Contact information

For additional information please visit <http://www.semiconductors.philips.com>. Fax: **+31 40 27 24825**

For sales offices addresses send e-mail to: sales.addresses@www.semiconductors.philips.com.

© Koninklijke Philips Electronics N.V. 2004

SCA76

All rights are reserved. Reproduction in whole or in part is prohibited without the prior written consent of the copyright owner.

The information presented in this document does not form part of any quotation or contract, is believed to be accurate and reliable and may be changed without notice. No liability will be accepted by the publisher for any consequence of its use. Publication thereof does not convey nor imply any license under patent- or other industrial or intellectual property rights.

Printed in The Netherlands

R32/01/pp54

Date of release: 2004 Feb 24

Document order number: 9397 750 11401

Let's make things better.

**Philips
Semiconductors**



PHILIPS